

# Competitive Programmer's Handbook

Antti Laaksonen

Draft July 8, 2017



# Contents

|                                       |           |
|---------------------------------------|-----------|
| <b>Preface</b>                        | <b>ix</b> |
| <b>I Basic techniques</b>             | <b>1</b>  |
| <b>1 Introduction</b>                 | <b>3</b>  |
| 1.1 Programming languages . . . . .   | 3         |
| 1.2 Input and output . . . . .        | 4         |
| 1.3 Working with numbers . . . . .    | 6         |
| 1.4 Shortening code . . . . .         | 8         |
| 1.5 Mathematics . . . . .             | 10        |
| 1.6 Contests and resources . . . . .  | 15        |
| <b>2 Time complexity</b>              | <b>17</b> |
| 2.1 Calculation rules . . . . .       | 17        |
| 2.2 Complexity classes . . . . .      | 20        |
| 2.3 Estimating efficiency . . . . .   | 21        |
| 2.4 Maximum subarray sum . . . . .    | 21        |
| <b>3 Sorting</b>                      | <b>25</b> |
| 3.1 Sorting theory . . . . .          | 25        |
| 3.2 Sorting in C++ . . . . .          | 29        |
| 3.3 Binary search . . . . .           | 31        |
| <b>4 Data structures</b>              | <b>35</b> |
| 4.1 Dynamic arrays . . . . .          | 35        |
| 4.2 Set structures . . . . .          | 37        |
| 4.3 Map structures . . . . .          | 38        |
| 4.4 Iterators and ranges . . . . .    | 39        |
| 4.5 Other structures . . . . .        | 41        |
| 4.6 Comparison to sorting . . . . .   | 44        |
| <b>5 Complete search</b>              | <b>47</b> |
| 5.1 Generating subsets . . . . .      | 47        |
| 5.2 Generating permutations . . . . . | 49        |
| 5.3 Backtracking . . . . .            | 50        |
| 5.4 Pruning the search . . . . .      | 51        |
| 5.5 Meet in the middle . . . . .      | 54        |

|  |            |
|--|------------|
| <b>6 Greedy algorithms</b>                   | <b>57</b>  |
| 6.1 Coin problem . . . . .                   | 57         |
| 6.2 Scheduling . . . . .                     | 58         |
| 6.3 Tasks and deadlines . . . . .            | 60         |
| 6.4 Minimizing sums . . . . .                | 61         |
| 6.5 Data compression . . . . .               | 62         |
| <b>7 Dynamic programming</b>                 | <b>65</b>  |
| 7.1 Coin problem . . . . .                   | 65         |
| 7.2 Longest increasing subsequence . . . . . | 70         |
| 7.3 Paths in a grid . . . . .                | 71         |
| 7.4 Knapsack problems . . . . .              | 72         |
| 7.5 Edit distance . . . . .                  | 74         |
| 7.6 Counting tilings . . . . .               | 75         |
| <b>8 Amortized analysis</b>                  | <b>77</b>  |
| 8.1 Two pointers method . . . . .            | 77         |
| 8.2 Nearest smaller elements . . . . .       | 79         |
| 8.3 Sliding window minimum . . . . .         | 81         |
| <b>9 Range queries</b>                       | <b>83</b>  |
| 9.1 Static array queries . . . . .           | 84         |
| 9.2 Binary indexed tree . . . . .            | 86         |
| 9.3 Segment tree . . . . .                   | 89         |
| 9.4 Additional techniques . . . . .          | 93         |
| <b>10 Bit manipulation</b>                   | <b>95</b>  |
| 10.1 Bit representation . . . . .            | 95         |
| 10.2 Bit operations . . . . .                | 96         |
| 10.3 Representing sets . . . . .             | 98         |
| 10.4 Bit optimizations . . . . .             | 100        |
| 10.5 Dynamic programming . . . . .           | 102        |
| <b>II Graph algorithms</b>                   | <b>107</b> |
| <b>11 Basics of graphs</b>                   | <b>109</b> |
| 11.1 Graph terminology . . . . .             | 109        |
| 11.2 Graph representation . . . . .          | 113        |
| <b>12 Graph traversal</b>                    | <b>117</b> |
| 12.1 Depth-first search . . . . .            | 117        |
| 12.2 Breadth-first search . . . . .          | 119        |
| 12.3 Applications . . . . .                  | 121        |

|   |            |
|---|------------|
| <b>13 Shortest paths</b>                | <b>123</b> |
| 13.1 Bellman–Ford algorithm . . . . .   | 123        |
| 13.2 Dijkstra’s algorithm . . . . .     | 126        |
| 13.3 Floyd–Warshall algorithm . . . . . | 129        |
| <b>14 Tree algorithms</b>               | <b>133</b> |
| 14.1 Tree traversal . . . . .           | 134        |
| 14.2 Diameter . . . . .                 | 135        |
| 14.3 All longest paths . . . . .        | 137        |
| 14.4 Binary trees . . . . .             | 139        |
| <b>15 Spanning trees</b>                | <b>141</b> |
| 15.1 Kruskal’s algorithm . . . . .      | 142        |
| 15.2 Union-find structure . . . . .     | 145        |
| 15.3 Prim’s algorithm . . . . .         | 147        |
| <b>16 Directed graphs</b>               | <b>149</b> |
| 16.1 Topological sorting . . . . .      | 149        |
| 16.2 Dynamic programming . . . . .      | 151        |
| 16.3 Successor paths . . . . .          | 154        |
| 16.4 Cycle detection . . . . .          | 155        |
| <b>17 Strong connectivity</b>           | <b>157</b> |
| 17.1 Kosaraju’s algorithm . . . . .     | 158        |
| 17.2 2SAT problem . . . . .             | 160        |
| <b>18 Tree queries</b>                  | <b>163</b> |
| 18.1 Finding ancestors . . . . .        | 163        |
| 18.2 Subtrees and paths . . . . .       | 164        |
| 18.3 Lowest common ancestor . . . . .   | 167        |
| 18.4 Offline algorithms . . . . .       | 170        |
| <b>19 Paths and circuits</b>            | <b>173</b> |
| 19.1 Eulerian paths . . . . .           | 173        |
| 19.2 Hamiltonian paths . . . . .        | 177        |
| 19.3 De Bruijn sequences . . . . .      | 178        |
| 19.4 Knight’s tours . . . . .           | 179        |
| <b>20 Flows and cuts</b>                | <b>181</b> |
| 20.1 Ford–Fulkerson algorithm . . . . . | 182        |
| 20.2 Disjoint paths . . . . .           | 186        |
| 20.3 Maximum matchings . . . . .        | 187        |
| 20.4 Path covers . . . . .              | 190        |

|            |                                  |            |
|------------|----------------------------------|------------|
| <b>III</b> | <b>Advanced topics</b>           | <b>195</b> |
| <b>21</b>  | <b>Number theory</b>             | <b>197</b> |
| 21.1       | Primes and factors . . . . .     | 197        |
| 21.2       | Modular arithmetic . . . . .     | 201        |
| 21.3       | Solving equations . . . . .      | 204        |
| 21.4       | Other results . . . . .          | 205        |
| <b>22</b>  | <b>Combinatorics</b>             | <b>207</b> |
| 22.1       | Binomial coefficients . . . . .  | 208        |
| 22.2       | Catalan numbers . . . . .        | 210        |
| 22.3       | Inclusion-exclusion . . . . .    | 212        |
| 22.4       | Burnside’s lemma . . . . .       | 214        |
| 22.5       | Cayley’s formula . . . . .       | 215        |
| <b>23</b>  | <b>Matrices</b>                  | <b>217</b> |
| 23.1       | Operations . . . . .             | 217        |
| 23.2       | Linear recurrences . . . . .     | 220        |
| 23.3       | Graphs and matrices . . . . .    | 222        |
| <b>24</b>  | <b>Probability</b>               | <b>225</b> |
| 24.1       | Calculation . . . . .            | 225        |
| 24.2       | Events . . . . .                 | 226        |
| 24.3       | Random variables . . . . .       | 228        |
| 24.4       | Markov chains . . . . .          | 230        |
| 24.5       | Randomized algorithms . . . . .  | 231        |
| <b>25</b>  | <b>Game theory</b>               | <b>235</b> |
| 25.1       | Game states . . . . .            | 235        |
| 25.2       | Nim game . . . . .               | 237        |
| 25.3       | Sprague–Grundy theorem . . . . . | 238        |
| <b>26</b>  | <b>String algorithms</b>         | <b>243</b> |
| 26.1       | String terminology . . . . .     | 243        |
| 26.2       | Trie structure . . . . .         | 244        |
| 26.3       | String hashing . . . . .         | 245        |
| 26.4       | Z-algorithm . . . . .            | 247        |
| <b>27</b>  | <b>Square root algorithms</b>    | <b>251</b> |
| 27.1       | Combining algorithms . . . . .   | 252        |
| 27.2       | Integer partitions . . . . .     | 254        |
| 27.3       | Mo’s algorithm . . . . .         | 255        |
| <b>28</b>  | <b>Segment trees revisited</b>   | <b>257</b> |
| 28.1       | Lazy propagation . . . . .       | 258        |
| 28.2       | Dynamic trees . . . . .          | 261        |
| 28.3       | Data structures . . . . .        | 263        |
| 28.4       | Two-dimensionality . . . . .     | 264        |

|                                     |            |
|-------------------------------------|------------|
| <b>29 Geometry</b>                  | <b>265</b> |
| 29.1 Complex numbers . . . . .      | 266        |
| 29.2 Points and lines . . . . .     | 268        |
| 29.3 Polygon area . . . . .         | 271        |
| 29.4 Distance functions . . . . .   | 272        |
| <b>30 Sweep line algorithms</b>     | <b>275</b> |
| 30.1 Intersection points . . . . .  | 276        |
| 30.2 Closest pair problem . . . . . | 277        |
| 30.3 Convex hull problem . . . . .  | 278        |
| <b>Bibliography</b>                 | <b>281</b> |
| <b>Index</b>                        | <b>287</b> |





# Preface

The purpose of this book is to give you a thorough introduction to competitive programming. It is assumed that you already know the basics of programming, but previous background on competitive programming is not needed.

The book is especially intended for students who want to learn algorithms and possibly participate in the International Olympiad in Informatics (IOI) or in the International Collegiate Programming Contest (ICPC). Of course, the book is also suitable for anybody else interested in competitive programming.

It takes a long time to become a good competitive programmer, but it is also an opportunity to learn a lot. You can be sure that you will get a good general understanding of algorithms if you spend time reading the book, solving problems and taking part in contests.

The book is under continuous development. You can always send feedback on the book to [ahslaaks@cs.helsinki.fi](mailto:ahslaaks@cs.helsinki.fi).

Helsinki, July 2017  
Antti Laaksonen



**Part I**

**Basic techniques**



# Chapter 1

## Introduction

Competitive programming combines two topics: (1) the design of algorithms and (2) the implementation of algorithms.

The **design of algorithms** consists of problem solving and mathematical thinking. Skills for analyzing problems and solving them creatively are needed. An algorithm for solving a problem has to be both correct and efficient, and the core of the problem is often about inventing an efficient algorithm.

Theoretical knowledge of algorithms is important to competitive programmers. Typically, a solution to a problem is a combination of well-known techniques and new insights. The techniques that appear in competitive programming also form the basis for the scientific research of algorithms.

The **implementation of algorithms** requires good programming skills. In competitive programming, the solutions are graded by testing an implemented algorithm using a set of test cases. Thus, it is not enough that the idea of the algorithm is correct, but the implementation also has to be correct.

A good coding style in contests is straightforward and concise. Programs should be written quickly, because there is not much time available. Unlike in traditional software engineering, the programs are short (usually at most some hundreds of lines) and it is not needed to maintain them after the contest.

### 1.1 Programming languages

At the moment, the most popular programming languages used in contests are C++, Python and Java. For example, in Google Code Jam 2017, among the best 3,000 participants, 79 % used C++, 16 % used Python and 8 % used Java [29]. Some participants also used several languages.

Many people think that C++ is the best choice for a competitive programmer, and C++ is nearly always available in contest systems. The benefits in using C++ are that it is a very efficient language and its standard library contains a large collection of data structures and algorithms.

On the other hand, it is good to master several languages and understand their strengths. For example, if large integers are needed in the problem, Python can be a good choice, because it contains built-in operations for calculating with

large integers. Still, most problems in programming contests are set so that using a specific programming language is not an unfair advantage.

All example programs in this book are written in C++, and the standard library's data structures and algorithms are often used. The programs follow the C++11 standard, which can be used in most contests nowadays. If you cannot program in C++ yet, now is a good time to start learning.

## C++ code template

A typical C++ code template for competitive programming looks like this:

```
#include <bits/stdc++.h>

using namespace std;

int main() {
    // solution comes here
}
```

The `#include` line at the beginning of the code is a feature of the g++ compiler that allows us to include the entire standard library. Thus, it is not needed to separately include libraries such as `iostream`, `vector` and `algorithm`, but rather they are available automatically.

The `using` line declares that the classes and functions of the standard library can be used directly in the code. Without the `using` line we would have to write, for example, `std::cout`, but now it suffices to write `cout`.

The code can be compiled using the following command:

```
g++ -std=c++11 -O2 -Wall test.cpp -o test
```

This command produces a binary file `test` from the source code `test.cpp`. The compiler follows the C++11 standard (`-std=c++11`), optimizes the code (`-O2`) and shows warnings about possible errors (`-Wall`).

## 1.2 Input and output

In most contests, standard streams are used for reading input and writing output. In C++, the standard streams are `cin` for input and `cout` for output. In addition, the C functions `scanf` and `printf` can be used.

The input for the program usually consists of numbers and strings that are separated with spaces and newlines. They can be read from the `cin` stream as follows:

```
int a, b;
string x;
cin >> a >> b >> x;
```

This kind of code always works, assuming that there is at least one space or newline between each element in the input. For example, the above code can read both the following inputs:

```
123 456 monkey
```

```
123 456
monkey
```

The cout stream is used for output as follows:

```
int a = 123, b = 456;
string x = "monkey";
cout << a << " " << b << " " << x << "\n";
```

Input and output is sometimes a bottleneck in the program. The following lines at the beginning of the code make input and output more efficient:

```
ios::sync_with_stdio(0);
cin.tie(0);
```

Note that the newline "\n" works faster than endl, because endl always causes a flush operation.

The C functions scanf and printf are an alternative to the C++ standard streams. They are usually a bit faster, but they are also more difficult to use. The following code reads two integers from the input:

```
int a, b;
scanf("%d %d", &a, &b);
```

The following code prints two integers:

```
int a = 123, b = 456;
printf("%d %d\n", a, b);
```

Sometimes the program should read a whole line from the input, possibly containing spaces. This can be accomplished by using the getline function:

```
string s;
getline(cin, s);
```

If the amount of data is unknown, the following loop is useful:

```
while (cin >> x) {
    // code
}
```

This loop reads elements from the input one after another, until there is no more data available in the input.

In some contest systems, files are used for input and output. An easy solution for this is to write the code as usual using standard streams, but add the following lines to the beginning of the code:

```
freopen("input.txt", "r", stdin);
freopen("output.txt", "w", stdout);
```

After this, the program reads the input from the file "input.txt" and writes the output to the file "output.txt".

## 1.3 Working with numbers

### Integers

The most used integer type in competitive programming is `int`, which is a 32-bit type with a value range of  $-2^{31} \dots 2^{31} - 1$  or about  $-2 \cdot 10^9 \dots 2 \cdot 10^9$ . If the type `int` is not enough, the 64-bit type `long long` can be used. It has a value range of  $-2^{63} \dots 2^{63} - 1$  or about  $-9 \cdot 10^{18} \dots 9 \cdot 10^{18}$ .

The following code defines a `long long` variable:

```
long long x = 123456789123456789LL;
```

The suffix `LL` means that the type of the number is `long long`.

A common mistake when using the type `long long` is that the type `int` is still used somewhere in the code. For example, the following code contains a subtle error:

```
int a = 123456789;
long long b = a*a;
cout << b << "\n"; // -1757895751
```

Even though the variable `b` is of type `long long`, both numbers in the expression `a*a` are of type `int` and the result is also of type `int`. Because of this, the variable `b` will contain a wrong result. The problem can be solved by changing the type of `a` to `long long` or by changing the expression to `(long long)a*a`.

Usually contest problems are set so that the type `long long` is enough. Still, it is good to know that the `g++` compiler also provides a 128-bit type `__int128_t` with a value range of  $-2^{127} \dots 2^{127} - 1$  or about  $-10^{38} \dots 10^{38}$ . However, this type is not available in all contest systems.

### Modular arithmetic

We denote by  $x \bmod m$  the remainder when  $x$  is divided by  $m$ . For example,  $17 \bmod 5 = 2$ , because  $17 = 3 \cdot 5 + 2$ .

Sometimes, the answer to a problem is a very large number but it is enough to output it "modulo  $m$ ", i.e., the remainder when the answer is divided by  $m$  (for



example, "modulo  $10^9 + 7$ "). The idea is that even if the actual answer is very large, it suffices to use the types `int` and `long long`.

An important property of the remainder is that in addition, subtraction and multiplication, the remainder can be taken before the operation:

$$\begin{aligned}(a + b) \bmod m &= (a \bmod m + b \bmod m) \bmod m \\(a - b) \bmod m &= (a \bmod m - b \bmod m) \bmod m \\(a \cdot b) \bmod m &= (a \bmod m \cdot b \bmod m) \bmod m\end{aligned}$$

Thus, we can take the remainder after every operation and the numbers will never become too large.

For example, the following code calculates  $n!$ , the factorial of  $n$ , modulo  $m$ :

```
long long x = 1;
for (int i = 2; i <= n; i++) {
    x = (x*i)%m;
}
cout << x%m << "\n";
```

Usually we want the remainder to always be between  $0 \dots m - 1$ . However, in C++ and other languages, the remainder of a negative number is either zero or negative. An easy way to make sure there are no negative remainders is to first calculate the remainder as usual and then add  $m$  if the result is negative:

```
x = x%m;
if (x < 0) x += m;
```

However, this is only needed when there are subtractions in the code and the remainder may become negative.

## Floating point numbers

The usual floating point types in competitive programming are the 64-bit `double` and, as an extension in the `g++` compiler, the 80-bit `long double`. In most cases, `double` is enough, but `long double` is more accurate.

The required precision of the answer is usually given in the problem statement. An easy way to output the answer is to use the `printf` function and give the number of decimal places in the formatting string. For example, the following code prints the value of  $x$  with 9 decimal places:

```
printf("%.9f\n", x);
```

A difficulty when using floating point numbers is that some numbers cannot be represented accurately as floating point numbers, and there will be rounding errors. For example, the result of the following code is surprising:

```
double x = 0.3*3+0.1;
printf("%.20f\n", x); // 0.99999999999999988898
```

Due to a rounding error, the value of  $x$  is a bit smaller than 1, while the correct value would be 1.

It is risky to compare floating point numbers with the `==` operator, because it is possible that the values should be equal but they are not because of precision errors. A better way to compare floating point numbers is to assume that two numbers are equal if the difference between them is less than  $\epsilon$ , where  $\epsilon$  is a small number.

In practice, the numbers can be compared as follows ( $\epsilon = 10^{-9}$ ):

```
if (abs(a-b) < 1e-9) {  
    // a and b are equal  
}
```

Note that while floating point numbers are inaccurate, integers up to a certain limit can still be represented accurately. For example, using `double`, it is possible to accurately represent all integers whose absolute value is at most  $2^{53}$ .

## 1.4 Shortening code

Short code is ideal in competitive programming, because programs should be written as fast as possible. Because of this, competitive programmers often define shorter names for datatypes and other parts of code.

### Type names

Using the command `typedef` it is possible to give a shorter name to a datatype. For example, the name `long long` is long, so we can define a shorter name `ll`:

```
typedef long long ll;
```

After this, the code

```
long long a = 123456789;  
long long b = 987654321;  
cout << a*b << "\n";
```

can be shortened as follows:

```
ll a = 123456789;  
ll b = 987654321;  
cout << a*b << "\n";
```

The command `typedef` can also be used with more complex types. For example, the following code gives the name `vi` for a vector of integers and the name `pi` for a pair that contains two integers.

```
typedef vector<int> vi;  
typedef pair<int,int> pi;
```

## Macros

Another way to shorten code is to define **macros**. A macro means that certain strings in the code will be changed before the compilation. In C++, macros are defined using the `#define` keyword.

For example, we can define the following macros:

```
#define F first
#define S second
#define PB push_back
#define MP make_pair
```

After this, the code

```
v.push_back(make_pair(y1,x1));
v.push_back(make_pair(y2,x2));
int d = v[i].first+v[i].second;
```

can be shortened as follows:

```
v.PB(MP(y1,x1));
v.PB(MP(y2,x2));
int d = v[i].F+v[i].S;
```

A macro can also have parameters which makes it possible to shorten loops and other structures. For example, we can define the following macro:

```
#define REP(i,a,b) for (int i = a; i <= b; i++)
```

After this, the code

```
for (int i = 1; i <= n; i++) {
    search(i);
}
```

can be shortened as follows:

```
REP(i,1,n) {
    search(i);
}
```

Sometimes macros cause bugs that may be difficult to detect. For example, consider the following macro that calculates the square of a number:

```
#define SQ(a) a*a
```

This macro *does not* always work as expected. For example, the code

```
cout << SQ(3+3) << "\n";
```

corresponds to the code

```
cout << 3+3*3+3 << "\n"; // 15
```

A better version of the macro is as follows:

```
#define SQ(a) (a)*(a)
```

Now the code

```
cout << SQ(3+3) << "\n";
```

corresponds to the code

```
cout << (3+3)*(3+3) << "\n"; // 36
```

## 1.5 Mathematics

Mathematics plays an important role in competitive programming, and it is not possible to become a successful competitive programmer without having good mathematical skills. This section discusses some important mathematical concepts and formulas that are needed later in the book.

### Sum formulas

Each sum of the form

$$\sum_{x=1}^n x^k = 1^k + 2^k + 3^k + \dots + n^k,$$

where  $k$  is a positive integer, has a closed-form formula that is a polynomial of degree  $k + 1$ . For example<sup>1</sup>,

$$\sum_{x=1}^n x = 1 + 2 + 3 + \dots + n = \frac{n(n+1)}{2}$$

and

$$\sum_{x=1}^n x^2 = 1^2 + 2^2 + 3^2 + \dots + n^2 = \frac{n(n+1)(2n+1)}{6}.$$

An **arithmetic progression** is a sequence of numbers where the difference between any two consecutive numbers is constant. For example,

3, 7, 11, 15

---

<sup>1</sup> There is even a general formula for such sums, called **Faulhaber's formula**, but it is too complex to be presented here.

is an arithmetic progression with constant 4. The sum of an arithmetic progression can be calculated using the formula

$$\underbrace{a + \dots + b}_{n \text{ numbers}} = \frac{n(a + b)}{2}$$

where  $a$  is the first number,  $b$  is the last number and  $n$  is the amount of numbers. For example,

$$3 + 7 + 11 + 15 = \frac{4 \cdot (3 + 15)}{2} = 36.$$

The formula is based on the fact that the sum consists of  $n$  numbers and the value of each number is  $(a + b)/2$  on average.

A **geometric progression** is a sequence of numbers where the ratio between any two consecutive numbers is constant. For example,

$$3, 6, 12, 24$$

is a geometric progression with constant 2. The sum of a geometric progression can be calculated using the formula

$$a + ak + ak^2 + \dots + b = \frac{bk - a}{k - 1}$$

where  $a$  is the first number,  $b$  is the last number and the ratio between consecutive numbers is  $k$ . For example,

$$3 + 6 + 12 + 24 = \frac{24 \cdot 2 - 3}{2 - 1} = 45.$$

This formula can be derived as follows. Let

$$S = a + ak + ak^2 + \dots + b.$$

By multiplying both sides by  $k$ , we get

$$kS = ak + ak^2 + ak^3 + \dots + bk,$$

and solving the equation

$$kS - S = bk - a$$

yields the formula.

A special case of a sum of a geometric progression is the formula

$$1 + 2 + 4 + 8 + \dots + 2^{n-1} = 2^n - 1.$$

A **harmonic sum** is a sum of the form

$$\sum_{x=1}^n \frac{1}{x} = 1 + \frac{1}{2} + \frac{1}{3} + \dots + \frac{1}{n}.$$

An upper bound for a harmonic sum is  $\log_2(n) + 1$ . Namely, we can modify each term  $1/k$  so that  $k$  becomes the nearest power of two that does not exceed  $k$ . For example, when  $n = 6$ , we can estimate the sum as follows:

$$1 + \frac{1}{2} + \frac{1}{3} + \frac{1}{4} + \frac{1}{5} + \frac{1}{6} \leq 1 + \frac{1}{2} + \frac{1}{2} + \frac{1}{4} + \frac{1}{4} + \frac{1}{4}.$$

This upper bound consists of  $\log_2(n) + 1$  parts (1,  $2 \cdot 1/2$ ,  $4 \cdot 1/4$ , etc.), and the value of each part is at most 1.

## Set theory

A **set** is a collection of elements. For example, the set

$$X = \{2, 4, 7\}$$

contains elements 2, 4 and 7. The symbol  $\emptyset$  denotes an empty set, and  $|S|$  denotes the size of a set  $S$ , i.e., the number of elements in the set. For example, in the above set,  $|X| = 3$ .

If a set  $S$  contains an element  $x$ , we write  $x \in S$ , and otherwise we write  $x \notin S$ . For example, in the above set

$$4 \in X \quad \text{and} \quad 5 \notin X.$$

New sets can be constructed using set operations:

- The **intersection**  $A \cap B$  consists of elements that are in both  $A$  and  $B$ . For example, if  $A = \{1, 2, 5\}$  and  $B = \{2, 4\}$ , then  $A \cap B = \{2\}$ .
- The **union**  $A \cup B$  consists of elements that are in  $A$  or  $B$  or both. For example, if  $A = \{3, 7\}$  and  $B = \{2, 3, 8\}$ , then  $A \cup B = \{2, 3, 7, 8\}$ .
- The **complement**  $\bar{A}$  consists of elements that are not in  $A$ . The interpretation of a complement depends on the **universal set**, which contains all possible elements. For example, if  $A = \{1, 2, 5, 7\}$  and the universal set is  $\{1, 2, \dots, 10\}$ , then  $\bar{A} = \{3, 4, 6, 8, 9, 10\}$ .
- The **difference**  $A \setminus B = A \cap \bar{B}$  consists of elements that are in  $A$  but not in  $B$ . Note that  $B$  can contain elements that are not in  $A$ . For example, if  $A = \{2, 3, 7, 8\}$  and  $B = \{3, 5, 8\}$ , then  $A \setminus B = \{2, 7\}$ .

If each element of  $A$  also belongs to  $S$ , we say that  $A$  is a **subset** of  $S$ , denoted by  $A \subset S$ . A set  $S$  always has  $2^{|S|}$  subsets, including the empty set. For example, the subsets of the set  $\{2, 4, 7\}$  are

$$\emptyset, \{2\}, \{4\}, \{7\}, \{2, 4\}, \{2, 7\}, \{4, 7\} \text{ and } \{2, 4, 7\}.$$

Some often used sets are  $\mathbb{N}$  (natural numbers),  $\mathbb{Z}$  (integers),  $\mathbb{Q}$  (rational numbers) and  $\mathbb{R}$  (real numbers). The set  $\mathbb{N}$  can be defined in two ways, depending on the situation: either  $\mathbb{N} = \{0, 1, 2, \dots\}$  or  $\mathbb{N} = \{1, 2, 3, \dots\}$ .

We can also construct a set using a rule of the form

$$\{f(n) : n \in S\},$$

where  $f(n)$  is some function. This set contains all elements of the form  $f(n)$ , where  $n$  is an element in  $S$ . For example, the set

$$X = \{2n : n \in \mathbb{Z}\}$$

contains all even integers.

## Logic

The value of a logical expression is either **true** (1) or **false** (0). The most important logical operators are  $\neg$  (**negation**),  $\wedge$  (**conjunction**),  $\vee$  (**disjunction**),  $\Rightarrow$  (**implication**) and  $\Leftrightarrow$  (**equivalence**). The following table shows the meanings of these operators:

| $A$ | $B$ | $\neg A$ | $\neg B$ | $A \wedge B$ | $A \vee B$ | $A \Rightarrow B$ | $A \Leftrightarrow B$ |
|-----|-----|----------|----------|--------------|------------|-------------------|-----------------------|
| 0   | 0   | 1        | 1        | 0            | 0          | 1                 | 1                     |
| 0   | 1   | 1        | 0        | 0            | 1          | 1                 | 0                     |
| 1   | 0   | 0        | 1        | 0            | 1          | 0                 | 0                     |
| 1   | 1   | 0        | 0        | 1            | 1          | 1                 | 1                     |

The expression  $\neg A$  has the opposite value of  $A$ . The expression  $A \wedge B$  is true if both  $A$  and  $B$  are true, and the expression  $A \vee B$  is true if  $A$  or  $B$  or both are true. The expression  $A \Rightarrow B$  is true if whenever  $A$  is true, also  $B$  is true. The expression  $A \Leftrightarrow B$  is true if  $A$  and  $B$  are both true or both false.

A **predicate** is an expression that is true or false depending on its parameters. Predicates are usually denoted by capital letters. For example, we can define a predicate  $P(x)$  that is true exactly when  $x$  is a prime number. Using this definition,  $P(7)$  is true but  $P(8)$  is false.

A **quantifier** connects a logical expression to the elements of a set. The most important quantifiers are  $\forall$  (**for all**) and  $\exists$  (**there is**). For example,

$$\forall x(\exists y(y < x))$$

means that for each element  $x$  in the set, there is an element  $y$  in the set such that  $y$  is smaller than  $x$ . This is true in the set of integers, but false in the set of natural numbers.

Using the notation described above, we can express many kinds of logical propositions. For example,

$$\forall x((x > 1 \wedge \neg P(x)) \Rightarrow (\exists a(\exists b(a > 1 \wedge b > 1 \wedge x = ab))))$$

means that if a number  $x$  is larger than 1 and not a prime number, then there are numbers  $a$  and  $b$  that are larger than 1 and whose product is  $x$ . This proposition is true in the set of integers.

## Functions

The function  $\lfloor x \rfloor$  rounds the number  $x$  down to an integer, and the function  $\lceil x \rceil$  rounds the number  $x$  up to an integer. For example,

$$\lfloor 3/2 \rfloor = 1 \quad \text{and} \quad \lceil 3/2 \rceil = 2.$$

The functions  $\min(x_1, x_2, \dots, x_n)$  and  $\max(x_1, x_2, \dots, x_n)$  give the smallest and largest of values  $x_1, x_2, \dots, x_n$ . For example,

$$\min(1, 2, 3) = 1 \quad \text{and} \quad \max(1, 2, 3) = 3.$$

The **factorial**  $n!$  can be defined

$$\prod_{x=1}^n x = 1 \cdot 2 \cdot 3 \cdot \dots \cdot n$$

or recursively

$$\begin{aligned} 0! &= 1 \\ n! &= n \cdot (n-1)! \end{aligned}$$

The **Fibonacci numbers** arise in many situations. They can be defined recursively as follows:

$$\begin{aligned} f(0) &= 0 \\ f(1) &= 1 \\ f(n) &= f(n-1) + f(n-2) \end{aligned}$$

The first Fibonacci numbers are

$$0, 1, 1, 2, 3, 5, 8, 13, 21, 34, 55, \dots$$

There is also a closed-form formula for calculating Fibonacci numbers, which is sometimes called **Binet's formula**:

$$f(n) = \frac{(1 + \sqrt{5})^n - (1 - \sqrt{5})^n}{2^n \sqrt{5}}.$$

## Logarithms

The **logarithm** of a number  $x$  is denoted  $\log_k(x)$ , where  $k$  is the base of the logarithm. According to the definition,  $\log_k(x) = a$  exactly when  $k^a = x$ .

A useful property of logarithms is that  $\log_k(x)$  equals the number of times we have to divide  $x$  by  $k$  before we reach the number 1. For example,  $\log_2(32) = 5$  because 5 divisions by 2 are needed:

$$32 \rightarrow 16 \rightarrow 8 \rightarrow 4 \rightarrow 2 \rightarrow 1$$

Logarithms are often used in the analysis of algorithms, because many efficient algorithms halve something at each step. Hence, we can estimate the efficiency of such algorithms using logarithms.

The logarithm of a product is

$$\log_k(ab) = \log_k(a) + \log_k(b),$$

and consequently,

$$\log_k(x^n) = n \cdot \log_k(x).$$

In addition, the logarithm of a quotient is

$$\log_k\left(\frac{a}{b}\right) = \log_k(a) - \log_k(b).$$

Another useful formula is

$$\log_u(x) = \frac{\log_k(x)}{\log_k(u)},$$



and using this, it is possible to calculate logarithms to any base if there is a way to calculate logarithms to some fixed base.

The **natural logarithm**  $\ln(x)$  of a number  $x$  is a logarithm whose base is  $e \approx 2.71828$ . Another property of logarithms is that the number of digits of an integer  $x$  in base  $b$  is  $\lfloor \log_b(x) + 1 \rfloor$ . For example, the representation of 123 in base 2 is 1111011 and  $\lfloor \log_2(123) + 1 \rfloor = 7$ .

## 1.6 Contests and resources

### IOI

The International Olympiad in Informatics (IOI) is an annual programming contest for secondary school students. Each country is allowed to send a team of four students to the contest. There are usually about 300 participants from 80 countries.

The IOI consists of two five-hour long contests. In both contests, the participants are asked to solve three algorithm tasks of various difficulty. The tasks are divided into subtasks, each of which has an assigned score. Even if the contestants are divided into teams, they compete as individuals.

The IOI syllabus [41] regulates the topics that may appear in IOI tasks. Almost all the topics in the IOI syllabus are covered by this book.

Participants for the IOI are selected through national contests. Before the IOI, many regional contests are organized, such as the Baltic Olympiad in Informatics (BOI), the Central European Olympiad in Informatics (CEOI) and the Asia-Pacific Informatics Olympiad (APIO).

Some countries organize online practice contests for future IOI participants, such as the Croatian Open Competition in Informatics [11] and the USA Computing Olympiad [68]. In addition, a large collection of problems from Polish contests is available online [51].

### ICPC

The International Collegiate Programming Contest (ICPC) is an annual programming contest for university students. Each team in the contest consists of three students, and unlike in the IOI, the students work together; there is only one computer available for each team.

The ICPC consists of several stages, and finally the best teams are invited to the World Finals. While there are tens of thousands of participants in the contest, there are only a small number<sup>2</sup> of final slots available, so even advancing to the finals is a great achievement in some regions.

In each ICPC contest, the teams have five hours of time to solve about ten algorithm problems. A solution to a problem is accepted only if it solves all test cases efficiently. During the contest, competitors may view the results of other

---

<sup>2</sup>The exact number of final slots varies from year to year; in 2017, there were 133 final slots.

teams, but for the last hour the scoreboard is frozen and it is not possible to see the results of the last submissions.

The topics that may appear at the ICPC are not so well specified as those at the IOI. In any case, it is clear that more knowledge is needed at the ICPC, especially more mathematical skills.

## Online contests

There are also many online contests that are open for everybody. At the moment, the most active contest site is Codeforces, which organizes contests about weekly. In Codeforces, participants are divided into two divisions: beginners compete in Div2 and more experienced programmers in Div1. Other contest sites include AtCoder, CS Academy, HackerRank and Topcoder.

Some companies organize online contests with onsite finals. Examples of such contests are Facebook Hacker Cup, Google Code Jam and Yandex.Algorithm. Of course, companies also use those contests for recruiting: performing well in a contest is a good way to prove one's skills.

## Books

There are already some books (besides this book) that focus on competitive programming and algorithmic problem solving:

- S. S. Skiena and M. A. Revilla: *Programming Challenges: The Programming Contest Training Manual* [60]
- S. Halim and F. Halim: *Competitive Programming 3: The New Lower Bound of Programming Contests* [33]
- K. Diks et al.: *Looking for a Challenge? The Ultimate Problem Set from the University of Warsaw Programming Competitions* [15]

The first two books are intended for beginners, whereas the last book contains advanced material.

Of course, general algorithm books are also suitable for competitive programmers. Some popular books are:

- T. H. Cormen, C. E. Leiserson, R. L. Rivest and C. Stein: *Introduction to Algorithms* [13]
- J. Kleinberg and É. Tardos: *Algorithm Design* [45]
- S. S. Skiena: *The Algorithm Design Manual* [59]

# Chapter 2

## Time complexity

The efficiency of algorithms is important in competitive programming. Usually, it is easy to design an algorithm that solves the problem slowly, but the real challenge is to invent a fast algorithm. If the algorithm is too slow, it will get only partial points or no points at all.

The **time complexity** of an algorithm estimates how much time the algorithm will use for some input. The idea is to represent the efficiency as a function whose parameter is the size of the input. By calculating the time complexity, we can find out whether the algorithm is fast enough without implementing it.

### 2.1 Calculation rules

The time complexity of an algorithm is denoted  $O(\dots)$  where the three dots represent some function. Usually, the variable  $n$  denotes the input size. For example, if the input is an array of numbers,  $n$  will be the size of the array, and if the input is a string,  $n$  will be the length of the string.

#### Loops

A common reason why an algorithm is slow is that it contains many loops that go through the input. The more nested loops the algorithm contains, the slower it is. If there are  $k$  nested loops, the time complexity is  $O(n^k)$ .

For example, the time complexity of the following code is  $O(n)$ :

```
for (int i = 1; i <= n; i++) {  
    // code  
}
```

And the time complexity of the following code is  $O(n^2)$ :

```
for (int i = 1; i <= n; i++) {  
    for (int j = 1; j <= n; j++) {  
        // code  
    }  
}
```

## Order of magnitude

A time complexity does not tell us the exact number of times the code inside a loop is executed, but it only shows the order of magnitude. In the following examples, the code inside the loop is executed  $3n$ ,  $n + 5$  and  $\lceil n/2 \rceil$  times, but the time complexity of each code is  $O(n)$ .

```
for (int i = 1; i <= 3*n; i++) {  
    // code  
}
```

```
for (int i = 1; i <= n+5; i++) {  
    // code  
}
```

```
for (int i = 1; i <= n; i += 2) {  
    // code  
}
```

As another example, the time complexity of the following code is  $O(n^2)$ :

```
for (int i = 1; i <= n; i++) {  
    for (int j = i+1; j <= n; j++) {  
        // code  
    }  
}
```

## Phases

If the algorithm consists of consecutive phases, the total time complexity is the largest time complexity of a single phase. The reason for this is that the slowest phase is usually the bottleneck of the code.

For example, the following code consists of three phases with time complexities  $O(n)$ ,  $O(n^2)$  and  $O(n)$ . Thus, the total time complexity is  $O(n^2)$ .

```
for (int i = 1; i <= n; i++) {  
    // code  
}  
for (int i = 1; i <= n; i++) {  
    for (int j = 1; j <= n; j++) {  
        // code  
    }  
}  
for (int i = 1; i <= n; i++) {  
    // code  
}
```

## Several variables

Sometimes the time complexity depends on several factors. In this case, the time complexity formula contains several variables.

For example, the time complexity of the following code is  $O(nm)$ :

```
for (int i = 1; i <= n; i++) {
    for (int j = 1; j <= m; j++) {
        // code
    }
}
```

## Recursion

The time complexity of a recursive function depends on the number of times the function is called and the time complexity of a single call. The total time complexity is the product of these values.

For example, consider the following function:

```
void f(int n) {
    if (n == 1) return;
    f(n-1);
}
```

The call  $f(n)$  causes  $n$  function calls, and the time complexity of each call is  $O(1)$ . Thus, the total time complexity is  $O(n)$ .

As another example, consider the following function:

```
void g(int n) {
    if (n == 1) return;
    g(n-1);
    g(n-1);
}
```

In this case each function call generates two other calls, except for  $n = 1$ . Let us see what happens when  $g$  is called with parameter  $n$ . The following table shows the function calls produced by this single call:

| function call | number of calls |
|---------------|-----------------|
| $g(n)$        | 1               |
| $g(n-1)$      | 2               |
| $g(n-2)$      | 4               |
| ...           | ...             |
| $g(1)$        | $2^{n-1}$       |

Based on this, the time complexity is

$$1 + 2 + 4 + \dots + 2^{n-1} = 2^n - 1 = O(2^n).$$

## 2.2 Complexity classes

The following list contains common time complexities of algorithms:

- $O(1)$  The running time of a **constant-time** algorithm does not depend on the input size. A typical constant-time algorithm is a direct formula that calculates the answer.
- $O(\log n)$  A **logarithmic** algorithm often halves the input size at each step. The running time of such an algorithm is logarithmic, because  $\log_2 n$  equals the number of times  $n$  must be divided by 2 to get 1.
- $O(\sqrt{n})$  A **square root algorithm** is slower than  $O(\log n)$  but faster than  $O(n)$ . A special property of square roots is that  $\sqrt{n} = n/\sqrt{n}$ , so the square root  $\sqrt{n}$  lies, in some sense, in the middle of the input.
- $O(n)$  A **linear** algorithm goes through the input a constant number of times. This is often the best possible time complexity, because it is usually necessary to access each input element at least once before reporting the answer.
- $O(n \log n)$  This time complexity often indicates that the algorithm sorts the input, because the time complexity of efficient sorting algorithms is  $O(n \log n)$ . Another possibility is that the algorithm uses a data structure where each operation takes  $O(\log n)$  time.
- $O(n^2)$  A **quadratic** algorithm often contains two nested loops. It is possible to go through all pairs of the input elements in  $O(n^2)$  time.
- $O(n^3)$  A **cubic** algorithm often contains three nested loops. It is possible to go through all triplets of the input elements in  $O(n^3)$  time.
- $O(2^n)$  This time complexity often indicates that the algorithm iterates through all subsets of the input elements. For example, the subsets of  $\{1, 2, 3\}$  are  $\emptyset$ ,  $\{1\}$ ,  $\{2\}$ ,  $\{3\}$ ,  $\{1, 2\}$ ,  $\{1, 3\}$ ,  $\{2, 3\}$  and  $\{1, 2, 3\}$ .
- $O(n!)$  This time complexity often indicates that the algorithm iterates through all permutations of the input elements. For example, the permutations of  $\{1, 2, 3\}$  are  $(1, 2, 3)$ ,  $(1, 3, 2)$ ,  $(2, 1, 3)$ ,  $(2, 3, 1)$ ,  $(3, 1, 2)$  and  $(3, 2, 1)$ .

An algorithm is **polynomial** if its time complexity is at most  $O(n^k)$  where  $k$  is a constant. All the above time complexities except  $O(2^n)$  and  $O(n!)$  are polynomial. In practice, the constant  $k$  is usually small, and therefore a polynomial time complexity roughly means that the algorithm is *efficient*.

Most algorithms in this book are polynomial. Still, there are many important problems for which no polynomial algorithm is known, i.e., nobody knows how to solve them efficiently. **NP-hard** problems are an important set of problems, for which no polynomial algorithm is known<sup>1</sup>.

---

<sup>1</sup>A classic book on the topic is M. R. Garey's and D. S. Johnson's *Computers and Intractability: A Guide to the Theory of NP-Completeness* [28].

## 2.3 Estimating efficiency

By calculating the time complexity of an algorithm, it is possible to check, before implementing the algorithm, that it is efficient enough for the problem. The starting point for estimations is the fact that a modern computer can perform some hundreds of millions of operations in a second.

For example, assume that the time limit for a problem is one second and the input size is  $n = 10^5$ . If the time complexity is  $O(n^2)$ , the algorithm will perform about  $(10^5)^2 = 10^{10}$  operations. This should take at least some tens of seconds, so the algorithm seems to be too slow for solving the problem.

On the other hand, given the input size, we can try to *guess* the required time complexity of the algorithm that solves the problem. The following table contains some useful estimates assuming a time limit of one second.

| input size    | required time complexity |
|---------------|--------------------------|
| $n \leq 10$   | $O(n!)$                  |
| $n \leq 20$   | $O(2^n)$                 |
| $n \leq 500$  | $O(n^3)$                 |
| $n \leq 5000$ | $O(n^2)$                 |
| $n \leq 10^6$ | $O(n \log n)$ or $O(n)$  |
| $n$ is large  | $O(1)$ or $O(\log n)$    |

For example, if the input size is  $n = 10^5$ , it is probably expected that the time complexity of the algorithm is  $O(n)$  or  $O(n \log n)$ . This information makes it easier to design the algorithm, because it rules out approaches that would yield an algorithm with a worse time complexity.

Still, it is important to remember that a time complexity is only an estimate of efficiency, because it hides the *constant factors*. For example, an algorithm that runs in  $O(n)$  time may perform  $n/2$  or  $5n$  operations. This has an important effect on the actual running time of the algorithm.

## 2.4 Maximum subarray sum

There are often several possible algorithms for solving a problem such that their time complexities are different. This section discusses a classic problem that has a straightforward  $O(n^3)$  solution. However, by designing a better algorithm, it is possible to solve the problem in  $O(n^2)$  time and even in  $O(n)$  time.

Given an array of  $n$  numbers, our task is to calculate the **maximum subarray sum**, i.e., the largest possible sum of a sequence of consecutive values in the array<sup>2</sup>. The problem is interesting when there may be negative values in the array. For example, in the array

|    |   |   |    |   |   |    |   |
|----|---|---|----|---|---|----|---|
| -1 | 2 | 4 | -3 | 5 | 2 | -5 | 2 |
|----|---|---|----|---|---|----|---|

---

<sup>2</sup>J. Bentley's book *Programming Pearls* [8] made the problem popular.

the following subarray produces the maximum sum 10:

|    |   |   |    |   |   |    |   |
|----|---|---|----|---|---|----|---|
| -1 | 2 | 4 | -3 | 5 | 2 | -5 | 2 |
|----|---|---|----|---|---|----|---|

## Algorithm 1

A straightforward way to solve the problem is to go through all possible subarrays, calculate the sum of values in each subarray and maintain the maximum sum. The following code implements this algorithm:

```
int best = 0;
for (int a = 0; a < n; a++) {
    for (int b = a; b < n; b++) {
        int sum = 0;
        for (int k = a; k <= b; k++) {
            sum += array[k];
        }
        best = max(best, sum);
    }
}
cout << best << "\n";
```

The variables  $a$  and  $b$  fix the first and last index of the subarray, and the sum of values is calculated to the variable  $sum$ . The variable  $best$  contains the maximum sum found during the search.

The time complexity of the algorithm is  $O(n^3)$ , because it consists of three nested loops that go through the input.

## Algorithm 2

It is easy to make Algorithm 1 more efficient by removing one loop from it. This is possible by calculating the sum at the same time when the right end of the subarray moves. The result is the following code:

```
int best = 0;
for (int a = 0; a < n; a++) {
    int sum = 0;
    for (int b = a; b < n; b++) {
        sum += array[b];
        best = max(best, sum);
    }
}
cout << best << "\n";
```

After this change, the time complexity is  $O(n^2)$ .



### Algorithm 3

Surprisingly, it is possible to solve the problem in  $O(n)$  time<sup>3</sup>, which means that just one loop is enough. The idea is to calculate, for each array position, the maximum sum of a subarray that ends at that position. After this, the answer for the problem is the maximum of those sums.

Consider the subproblem of finding the maximum-sum subarray that ends at position  $k$ . There are two possibilities:

1. The subarray only contains the element at position  $k$ .
2. The subarray consists of a subarray that ends at position  $k - 1$ , followed by the element at position  $k$ .

In the latter case, since we want to find a subarray with maximum sum, the subarray that ends at position  $k - 1$  should also have the maximum sum. Thus, we can solve the problem efficiently by calculating the maximum subarray sum for each ending position from left to right.

The following code implements the algorithm:

```
int best = 0, sum = 0;
for (int k = 0; k < n; k++) {
    sum = max(array[k], sum+array[k]);
    best = max(best, sum);
}
cout << best << "\n";
```

The algorithm only contains one loop that goes through the input, so the time complexity is  $O(n)$ . This is also the best possible time complexity, because any algorithm for the problem has to examine all array elements at least once.

### Efficiency comparison

It is interesting to study how efficient algorithms are in practice. The following table shows the running times of the above algorithms for different values of  $n$  on a modern computer.

In each test, the input was generated randomly. The time needed for reading the input was not measured.

| array size $n$ | Algorithm 1 | Algorithm 2 | Algorithm 3 |
|----------------|-------------|-------------|-------------|
| $10^2$         | 0.0 s       | 0.0 s       | 0.0 s       |
| $10^3$         | 0.1 s       | 0.0 s       | 0.0 s       |
| $10^4$         | > 10.0 s    | 0.1 s       | 0.0 s       |
| $10^5$         | > 10.0 s    | 5.3 s       | 0.0 s       |
| $10^6$         | > 10.0 s    | > 10.0 s    | 0.0 s       |
| $10^7$         | > 10.0 s    | > 10.0 s    | 0.0 s       |

<sup>3</sup>In [8], this linear-time algorithm is attributed to J. B. Kadane, and the algorithm is sometimes called **Kadane's algorithm**.

The comparison shows that all algorithms are efficient when the input size is small, but larger inputs bring out remarkable differences in the running times of the algorithms. Algorithm 1 becomes slow when  $n = 10^4$ , and Algorithm 2 becomes slow when  $n = 10^5$ . Only Algorithm 3 is able to process even the largest inputs instantly.

# Chapter 3

## Sorting

**Sorting** is a fundamental algorithm design problem. Many efficient algorithms use sorting as a subroutine, because it is often easier to process data if the elements are in a sorted order.

For example, the problem "does an array contain two equal elements?" is easy to solve using sorting. If the array contains two equal elements, they will be next to each other after sorting, so it is easy to find them. Also, the problem "what is the most frequent element in an array?" can be solved similarly.

There are many algorithms for sorting, and they are also good examples of how to apply different algorithm design techniques. The efficient general sorting algorithms work in  $O(n \log n)$  time, and many algorithms that use sorting as a subroutine also have this time complexity.

### 3.1 Sorting theory

The basic problem in sorting is as follows:

Given an array that contains  $n$  elements, your task is to sort the elements in increasing order.

For example, the array

|   |   |   |   |   |   |   |   |
|---|---|---|---|---|---|---|---|
| 1 | 3 | 8 | 2 | 9 | 2 | 5 | 6 |
|---|---|---|---|---|---|---|---|

will be as follows after sorting:

|   |   |   |   |   |   |   |   |
|---|---|---|---|---|---|---|---|
| 1 | 2 | 2 | 3 | 5 | 6 | 8 | 9 |
|---|---|---|---|---|---|---|---|

#### $O(n^2)$ algorithms

Simple algorithms for sorting an array work in  $O(n^2)$  time. Such algorithms are short and usually consist of two nested loops. A famous  $O(n^2)$  time sorting

algorithm is **bubble sort** where the elements "bubble" in the array according to their values.

Bubble sort consists of  $n$  rounds. On each round, the algorithm iterates through the elements of the array. Whenever two consecutive elements are found that are not in correct order, the algorithm swaps them. The algorithm can be implemented as follows:

```
for (int i = 0; i < n; i++) {
    for (int j = 0; j < n-1; j++) {
        if (array[j] > array[j+1]) {
            swap(array[j],array[j+1]);
        }
    }
}
```

After the first round of the algorithm, the largest element will be in the correct position, and in general, after  $k$  rounds, the  $k$  largest elements will be in the correct positions. Thus, after  $n$  rounds, the whole array will be sorted.

For example, in the array

|   |   |   |   |   |   |   |   |
|---|---|---|---|---|---|---|---|
| 1 | 3 | 8 | 2 | 9 | 2 | 5 | 6 |
|---|---|---|---|---|---|---|---|

the first round of bubble sort swaps elements as follows:

|   |   |   |   |   |   |   |   |
|---|---|---|---|---|---|---|---|
| 1 | 3 | 2 | 8 | 9 | 2 | 5 | 6 |
|---|---|---|---|---|---|---|---|



|   |   |   |   |   |   |   |   |
|---|---|---|---|---|---|---|---|
| 1 | 3 | 2 | 8 | 2 | 9 | 5 | 6 |
|---|---|---|---|---|---|---|---|



|   |   |   |   |   |   |   |   |
|---|---|---|---|---|---|---|---|
| 1 | 3 | 2 | 8 | 2 | 5 | 9 | 6 |
|---|---|---|---|---|---|---|---|



|   |   |   |   |   |   |   |   |
|---|---|---|---|---|---|---|---|
| 1 | 3 | 2 | 8 | 2 | 5 | 6 | 9 |
|---|---|---|---|---|---|---|---|



## Inversions

Bubble sort is an example of a sorting algorithm that always swaps *consecutive* elements in the array. It turns out that the time complexity of such an algorithm is *always* at least  $O(n^2)$ , because in the worst case,  $O(n^2)$  swaps are required for sorting the array.

A useful concept when analyzing sorting algorithms is an **inversion**: a pair of array elements ( $\text{array}[a], \text{array}[b]$ ) such that  $a < b$  and  $\text{array}[a] > \text{array}[b]$ , i.e., the elements are in the wrong order. For example, the array

|   |   |   |   |   |   |   |   |
|---|---|---|---|---|---|---|---|
| 1 | 2 | 2 | 6 | 3 | 5 | 9 | 8 |
|---|---|---|---|---|---|---|---|

has three inversions: (6, 3), (6, 5) and (9, 8). The number of inversions indicates how much work is needed to sort the array. An array is completely sorted when there are no inversions. On the other hand, if the array elements are in the reverse order, the number of inversions is the largest possible:

$$1 + 2 + \dots + (n - 1) = \frac{n(n - 1)}{2} = O(n^2)$$

Swapping a pair of consecutive elements that are in the wrong order removes exactly one inversion from the array. Hence, if a sorting algorithm can only swap consecutive elements, each swap removes at most one inversion, and the time complexity of the algorithm is at least  $O(n^2)$ .

### $O(n \log n)$ algorithms

It is possible to sort an array efficiently in  $O(n \log n)$  time using algorithms that are not limited to swapping consecutive elements. One such algorithm is **merge sort**<sup>1</sup>, which is based on recursion.

Merge sort sorts a subarray array[ $a \dots b$ ] as follows:

1. If  $a = b$ , do not do anything, because the subarray is already sorted.
2. Calculate the position of the middle element:  $k = \lfloor (a + b)/2 \rfloor$ .
3. Recursively sort the subarray array[ $a \dots k$ ].
4. Recursively sort the subarray array[ $k + 1 \dots b$ ].
5. *Merge* the sorted subarrays array[ $a \dots k$ ] and array[ $k + 1 \dots b$ ] into a sorted subarray array[ $a \dots b$ ].

Merge sort is an efficient algorithm, because it halves the size of the subarray at each step. The recursion consists of  $O(\log n)$  levels, and processing each level takes  $O(n)$  time. Merging the subarrays array[ $a \dots k$ ] and array[ $k + 1 \dots b$ ] is possible in linear time, because they are already sorted.

For example, consider sorting the following array:

|   |   |   |   |   |   |   |   |
|---|---|---|---|---|---|---|---|
| 1 | 3 | 6 | 2 | 8 | 2 | 5 | 9 |
|---|---|---|---|---|---|---|---|

The array will be divided into two subarrays as follows:

|   |   |   |   |   |   |   |   |
|---|---|---|---|---|---|---|---|
| 1 | 3 | 6 | 2 | 8 | 2 | 5 | 9 |
|---|---|---|---|---|---|---|---|

Then, the subarrays will be sorted recursively as follows:

|   |   |   |   |   |   |   |   |
|---|---|---|---|---|---|---|---|
| 1 | 2 | 3 | 6 | 2 | 5 | 8 | 9 |
|---|---|---|---|---|---|---|---|

---

<sup>1</sup>According to [47], merge sort was invented by J. von Neumann in 1945.

Finally, the algorithm merges the sorted subarrays and creates the final sorted array:

|   |   |   |   |   |   |   |   |
|---|---|---|---|---|---|---|---|
| 1 | 2 | 2 | 3 | 5 | 6 | 8 | 9 |
|---|---|---|---|---|---|---|---|

## Sorting lower bound

Is it possible to sort an array faster than in  $O(n \log n)$  time? It turns out that this is *not* possible when we restrict ourselves to sorting algorithms that are based on comparing array elements.

The lower bound for the time complexity can be proved by considering sorting as a process where each comparison of two elements gives more information about the contents of the array. The process creates the following tree:

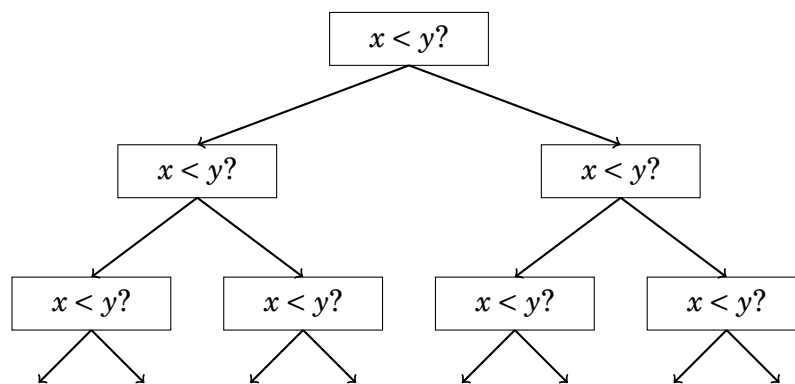

Here " $x < y$ ?" means that some elements  $x$  and  $y$  are compared. If  $x < y$ , the process continues to the left, and otherwise to the right. The results of the process are the possible ways to sort the array, a total of  $n!$  ways. For this reason, the height of the tree must be at least

$$\log_2(n!) = \log_2(1) + \log_2(2) + \dots + \log_2(n).$$

We get a lower bound for this sum by choosing the last  $n/2$  elements and changing the value of each element to  $\log_2(n/2)$ . This yields an estimate

$$\log_2(n!) \geq (n/2) \cdot \log_2(n/2),$$

so the height of the tree and the minimum possible number of steps in a sorting algorithm in the worst case is at least  $n \log n$ .

## Counting sort

The lower bound  $n \log n$  does not apply to algorithms that do not compare array elements but use some other information. An example of such an algorithm is **counting sort** that sorts an array in  $O(n)$  time assuming that every element in the array is an integer between  $0 \dots c$  and  $c = O(n)$ .

The algorithm creates a *bookkeeping* array, whose indices are elements of the original array. The algorithm iterates through the original array and calculates how many times each element appears in the array.

For example, the array

|   |   |   |   |   |   |   |   |
|---|---|---|---|---|---|---|---|
| 1 | 3 | 6 | 9 | 9 | 3 | 5 | 9 |
|---|---|---|---|---|---|---|---|

corresponds to the following bookkeeping array:

|   |   |   |   |   |   |   |   |   |
|---|---|---|---|---|---|---|---|---|
| 1 | 2 | 3 | 4 | 5 | 6 | 7 | 8 | 9 |
| 1 | 0 | 2 | 0 | 1 | 1 | 0 | 0 | 3 |

For example, the value at position 3 in the bookkeeping array is 2, because the element 3 appears 2 times in the original array.

Construction of the bookkeeping array takes  $O(n)$  time. After this, the sorted array can be created in  $O(n)$  time because the number of occurrences of each element can be retrieved from the bookkeeping array. Thus, the total time complexity of counting sort is  $O(n)$ .

Counting sort is a very efficient algorithm but it can only be used when the constant  $c$  is small enough, so that the array elements can be used as indices in the bookkeeping array.

## 3.2 Sorting in C++

It is almost never a good idea to use a home-made sorting algorithm in a contest, because there are good implementations available in programming languages. For example, the C++ standard library contains the function `sort` that can be easily used for sorting arrays and other data structures.

There are many benefits in using a library function. First, it saves time because there is no need to implement the function. Second, the library implementation is certainly correct and efficient: it is not probable that a home-made sorting function would be better.

In this section we will see how to use the C++ `sort` function. The following code sorts a vector in increasing order:

```
vector<int> v = {4,2,5,3,5,8,3};
sort(v.begin(),v.end());
```

After the sorting, the contents of the vector will be `[2,3,3,4,5,5,8]`. The default sorting order is increasing, but a reverse order is possible as follows:

```
sort(v.rbegin(),v.rend());
```

An ordinary array can be sorted as follows:

```
int n = 7; // array size
int a[] = {4,2,5,3,5,8,3};
sort(a,a+n);
```

The following code sorts the string `s`:

```
string s = "monkey";
sort(s.begin(), s.end());
```

Sorting a string means that the characters of the string are sorted. For example, the string "monkey" becomes "ekmnoy".

## Comparison operators

The function `sort` requires that a **comparison operator** is defined for the data type of the elements to be sorted. When sorting, this operator will be used whenever it is necessary to find out the order of two elements.

Most C++ data types have a built-in comparison operator, and elements of those types can be sorted automatically. For example, numbers are sorted according to their values and strings are sorted in alphabetical order.

Pairs (`pair`) are sorted primarily according to their first elements (`first`). However, if the first elements of two pairs are equal, they are sorted according to their second elements (`second`):

```
vector<pair<int,int>> v;
v.push_back({1,5});
v.push_back({2,3});
v.push_back({1,2});
sort(v.begin(), v.end());
```

After this, the order of the pairs is (1,2), (1,5) and (2,3).

In a similar way, tuples (`tuple`) are sorted primarily by the first element, secondarily by the second element, etc.<sup>2</sup>:

```
vector<tuple<int,int,int>> v;
v.push_back({2,1,4});
v.push_back({1,5,3});
v.push_back({2,1,3});
sort(v.begin(), v.end());
```

After this, the order of the tuples is (1,5,3), (2,1,3) and (2,1,4).

## User-defined structs

User-defined structs do not have a comparison operator automatically. The operator should be defined inside the struct as a function operator `<`, whose parameter is another element of the same type. The operator should return `true` if the element is smaller than the parameter, and `false` otherwise.

For example, the following struct `P` contains the `x` and `y` coordinates of a point. The comparison operator is defined so that the points are sorted primarily by the

---

<sup>2</sup>Note that in some older compilers, the function `make_tuple` has to be used to create a tuple instead of braces (for example, `make_tuple(2,1,4)` instead of `{2,1,4}`).



x coordinate and secondarily by the y coordinate.

```
struct P {
    int x, y;
    bool operator<(const P &p) {
        if (x != p.x) return x < p.x;
        else return y < p.y;
    }
};
```

## Comparison functions

It is also possible to give an external **comparison function** to the sort function as a callback function. For example, the following comparison function `comp` sorts strings primarily by length and secondarily by alphabetical order:

```
bool comp(string a, string b) {
    if (a.size() != b.size()) return a.size() < b.size();
    return a < b;
}
```

Now a vector of strings can be sorted as follows:

```
sort(v.begin(), v.end(), comp);
```

## 3.3 Binary search

A general method for searching for an element in an array is to use a for loop that iterates through the elements of the array. For example, the following code searches for an element  $x$  in an array:

```
for (int i = 0; i < n; i++) {
    if (array[i] == x) {
        // x found at index i
    }
}
```

The time complexity of this approach is  $O(n)$ , because in the worst case, it is necessary to check all elements of the array. If the order of the elements is arbitrary, this is also the best possible approach, because there is no additional information available where in the array we should search for the element  $x$ .

However, if the array is *sorted*, the situation is different. In this case it is possible to perform the search much faster, because the order of the elements in the array guides the search. The following **binary search** algorithm efficiently searches for an element in a sorted array in  $O(\log n)$  time.

## Method 1

The usual way to implement binary search resembles looking for a word in a dictionary. The search maintains an active region in the array, which initially contains all array elements. Then, a number of steps is performed, each of which halves the size of the region.

At each step, the search checks the middle element of the active region. If the middle element is the target element, the search terminates. Otherwise, the search recursively continues to the left or right half of the region, depending on the value of the middle element.

The above idea can be implemented as follows:

```
int a = 0, b = n-1;
while (a <= b) {
    int k = (a+b)/2;
    if (array[k] == x) {
        // x found at index k
    }
    if (array[k] > x) b = k-1;
    else a = k+1;
}
```

In this implementation, the active region is  $a \dots b$ , and initially the region is  $0 \dots n - 1$ . The algorithm halves the size of the region at each step, so the time complexity is  $O(\log n)$ .

## Method 2

An alternative method to implement binary search is based on an efficient way to iterate through the elements of the array. The idea is to make jumps and slow the speed when we get closer to the target element.

The search goes through the array from left to right, and the initial jump length is  $n/2$ . At each step, the jump length will be halved: first  $n/4$ , then  $n/8$ ,  $n/16$ , etc., until finally the length is 1. After the jumps, either the target element has been found or we know that it does not appear in the array.

The following code implements the above idea:

```
int k = 0;
for (int b = n/2; b >= 1; b /= 2) {
    while (k+b < n && array[k+b] <= x) k += b;
}
if (array[k] == x) {
    // x found at index k
}
```

During the search, the variable  $b$  contains the current jump length. The time complexity of the algorithm is  $O(\log n)$ , because the code in the while loop is performed at most twice for each jump length.

## C++ functions

The C++ standard library contains the following functions that are based on binary search and work in logarithmic time:

- `lower_bound` returns a pointer to the first array element whose value is at least  $x$ .
- `upper_bound` returns a pointer to the first array element whose value is larger than  $x$ .
- `equal_range` returns both above pointers.

The functions assume that the array is sorted. If there is no such element, the pointer points to the element after the last array element. For example, the following code finds out whether an array contains an element with value  $x$ :

```
auto k = lower_bound(array, array+n, x) - array;
if (k < n && array[k] == x) {
    // x found at index k
}
```

Then, the following code counts the number of elements whose value is  $x$ :

```
auto a = lower_bound(array, array+n, x);
auto b = upper_bound(array, array+n, x);
cout << b-a << "\n";
```

Using `equal_range`, the code becomes shorter:

```
auto r = equal_range(array, array+n, x);
cout << r.second-r.first << "\n";
```

## Finding the smallest solution

An important use for binary search is to find the position where the value of a *function* changes. Suppose that we wish to find the smallest value  $k$  that is a valid solution for a problem. We are given a function  $ok(x)$  that returns true if  $x$  is a valid solution and false otherwise. In addition, we know that  $ok(x)$  is false when  $x < k$  and true when  $x \geq k$ . The situation looks as follows:

|         |       |       |     |       |      |       |     |
|---------|-------|-------|-----|-------|------|-------|-----|
| $x$     | 0     | 1     | ... | $k-1$ | $k$  | $k+1$ | ... |
| $ok(x)$ | false | false | ... | false | true | true  | ... |

Now, the value of  $k$  can be found using binary search:

```
int x = -1;
for (int b = z; b >= 1; b /= 2) {
    while (!ok(x+b)) x += b;
}
int k = x+1;
```

The search finds the largest value of  $x$  for which  $ok(x)$  is false. Thus, the next value  $k = x + 1$  is the smallest possible value for which  $ok(k)$  is true. The initial jump length  $z$  has to be large enough, for example some value for which we know beforehand that  $ok(z)$  is true.

The algorithm calls the function  $ok$   $O(\log z)$  times, so the total time complexity depends on the function  $ok$ . For example, if the function works in  $O(n)$  time, the total time complexity is  $O(n \log z)$ .

## Finding the maximum value

Binary search can also be used to find the maximum value for a function that is first increasing and then decreasing. Our task is to find a position  $k$  such that

- $f(x) < f(x + 1)$  when  $x < k$ , and
- $f(x) > f(x + 1)$  when  $x \geq k$ .

The idea is to use binary search for finding the largest value of  $x$  for which  $f(x) < f(x + 1)$ . This implies that  $k = x + 1$  because  $f(x + 1) > f(x + 2)$ . The following code implements the search:

```
int x = -1;
for (int b = z; b >= 1; b /= 2) {
    while (f(x+b) < f(x+b+1)) x += b;
}
int k = x+1;
```

Note that unlike in the ordinary binary search, here it is not allowed that consecutive values of the function are equal. In this case it would not be possible to know how to continue the search.

# Chapter 4

## Data structures

A **data structure** is a way to store data in the memory of a computer. It is important to choose an appropriate data structure for a problem, because each data structure has its own advantages and disadvantages. The crucial question is: which operations are efficient in the chosen data structure?

This chapter introduces the most important data structures in the C++ standard library. It is a good idea to use the standard library whenever possible, because it will save a lot of time. Later in the book we will learn about more sophisticated data structures that are not available in the standard library.

### 4.1 Dynamic arrays

A **dynamic array** is an array whose size can be changed during the execution of the program. The most popular dynamic array in C++ is the vector structure, which can be used almost like an ordinary array.

The following code creates an empty vector and adds three elements to it:

```
vector<int> v;  
v.push_back(3); // [3]  
v.push_back(2); // [3,2]  
v.push_back(5); // [3,2,5]
```

After this, the elements can be accessed like in an ordinary array:

```
cout << v[0] << "\n"; // 3  
cout << v[1] << "\n"; // 2  
cout << v[2] << "\n"; // 5
```

The function `size` returns the number of elements in the vector. The following code iterates through the vector and prints all elements in it:

```
for (int i = 0; i < v.size(); i++) {  
    cout << v[i] << "\n";  
}
```

A shorter way to iterate through a vector is as follows:

```
for (auto x : v) {
    cout << x << "\n";
}
```

The function `back` returns the last element in the vector, and the function `pop_back` removes the last element:

```
vector<int> v;
v.push_back(5);
v.push_back(2);
cout << v.back() << "\n"; // 2
v.pop_back();
cout << v.back() << "\n"; // 5
```

The following code creates a vector with five elements:

```
vector<int> v = {2,4,2,5,1};
```

Another way to create a vector is to give the number of elements and the initial value for each element:

```
// size 10, initial value 0
vector<int> v(10);
```

```
// size 10, initial value 5
vector<int> v(10, 5);
```

The internal implementation of a vector uses an ordinary array. If the size of the vector increases and the array becomes too small, a new array is allocated and all the elements are moved to the new array. However, this does not happen often and the average time complexity of `push_back` is  $O(1)$ .

The string structure is also a dynamic array that can be used almost like a vector. In addition, there is special syntax for strings that is not available in other data structures. Strings can be combined using the `+` symbol. The function `substr( $k$ ,  $x$ )` returns the substring that begins at position  $k$  and has length  $x$ , and the function `find( $t$ )` finds the position of the first occurrence of a substring  $t$ .

The following code presents some string operations:

```
string a = "hatti";
string b = a+a;
cout << b << "\n"; // hattihatti
b[5] = 'v';
cout << b << "\n"; // hattivatti
string c = b.substr(3,4);
cout << c << "\n"; // tiva
```

## 4.2 Set structures

A **set** is a data structure that maintains a collection of elements. The basic operations of sets are element insertion, search and removal.

The C++ standard library contains two set implementations: The structure `set` is based on a balanced binary tree and its operations work in  $O(\log n)$  time. The structure `unordered_set` uses hashing, and its operations work in  $O(1)$  time on average.

The choice of which set implementation to use is often a matter of taste. The benefit of the `set` structure is that it maintains the order of the elements and provides functions that are not available in `unordered_set`. On the other hand, `unordered_set` can be more efficient.

The following code creates a set that contains integers, and shows some of the operations. The function `insert` adds an element to the set, the function `count` returns the number of occurrences of an element in the set, and the function `erase` removes an element from the set.

```
set<int> s;
s.insert(3);
s.insert(2);
s.insert(5);
cout << s.count(3) << "\n"; // 1
cout << s.count(4) << "\n"; // 0
s.erase(3);
s.insert(4);
cout << s.count(3) << "\n"; // 0
cout << s.count(4) << "\n"; // 1
```

A set can be used mostly like a vector, but it is not possible to access the elements using the `[]` notation. The following code creates a set, prints the number of elements in it, and then iterates through all the elements:

```
set<int> s = {2,5,6,8};
cout << s.size() << "\n"; // 4
for (auto x : s) {
    cout << x << "\n";
}
```

An important property of sets is that all their elements are *distinct*. Thus, the function `count` always returns either 0 (the element is not in the set) or 1 (the element is in the set), and the function `insert` never adds an element to the set if it is already there. The following code illustrates this:

```
set<int> s;
s.insert(5);
s.insert(5);
s.insert(5);
cout << s.count(5) << "\n"; // 1
```

C++ also contains the structures `multiset` and `unordered_multiset` that otherwise work like `set` and `unordered_set` but they can contain multiple instances of an element. For example, in the following code all three instances of the number 5 are added to a multiset:

```
multiset<int> s;
s.insert(5);
s.insert(5);
s.insert(5);
cout << s.count(5) << "\n"; // 3
```

The function `erase` removes all instances of an element from a multiset:

```
s.erase(5);
cout << s.count(5) << "\n"; // 0
```

Often, only one instance should be removed, which can be done as follows:

```
s.erase(s.find(5));
cout << s.count(5) << "\n"; // 2
```

## 4.3 Map structures

A **map** is a generalized array that consists of key-value-pairs. While the keys in an ordinary array are always the consecutive integers  $0, 1, \dots, n - 1$ , where  $n$  is the size of the array, the keys in a map can be of any data type and they do not have to be consecutive values.

The C++ standard library contains two map implementations that correspond to the set implementations: the structure `map` is based on a balanced binary tree and accessing elements takes  $O(\log n)$  time, while the structure `unordered_map` uses hashing and accessing elements takes  $O(1)$  time on average.

The following code creates a map where the keys are strings and the values are integers:

```
map<string,int> m;
m["monkey"] = 4;
m["banana"] = 3;
m["harpsichord"] = 9;
cout << m["banana"] << "\n"; // 3
```

If the value of a key is requested but the map does not contain it, the key is automatically added to the map with a default value. For example, in the following code, the key "aybaktu" with value 0 is added to the map.

```
map<string,int> m;
cout << m["aybaktu"] << "\n"; // 0
```



The function `count` checks if a key exists in a map:

```
if (m.count("aybaltu")) {  
    // key exists  
}
```

The following code prints all the keys and values in a map:

```
for (auto x : m) {  
    cout << x.first << " " << x.second << "\n";  
}
```

## 4.4 Iterators and ranges

Many functions in the C++ standard library operate with iterators. An **iterator** is a variable that points to an element in a data structure.

The often used iterators `begin` and `end` define a range that contains all elements in a data structure. The iterator `begin` points to the first element in the data structure, and the iterator `end` points to the position *after* the last element. The situation looks as follows:

```
    { 3, 4, 6, 8, 12, 13, 14, 17 }  
      ↑                               ↑  
      s.begin()                       s.end()
```

Note the asymmetry in the iterators: `s.begin()` points to an element in the data structure, while `s.end()` points outside the data structure. Thus, the range defined by the iterators is *half-open*.

### Working with ranges

Iterators are used in C++ standard library functions that are given a range of elements in a data structure. Usually, we want to process all elements in a data structure, so the iterators `begin` and `end` are given for the function.

For example, the following code sorts a vector using the function `sort`, then reverses the order of the elements using the function `reverse`, and finally shuffles the order of the elements using the function `random_shuffle`.

```
sort(v.begin(), v.end());  
reverse(v.begin(), v.end());  
random_shuffle(v.begin(), v.end());
```

These functions can also be used with an ordinary array. In this case, the functions are given pointers to the array instead of iterators:

```
sort(a, a+n);
reverse(a, a+n);
random_shuffle(a, a+n);
```

## Set iterators

Iterators are often used to access elements of a set. The following code creates an iterator `it` that points to the smallest element in a set:

```
set<int>::iterator it = s.begin();
```

A shorter way to write the code is as follows:

```
auto it = s.begin();
```

The element to which an iterator points can be accessed using the `*` symbol. For example, the following code prints the first element in the set:

```
auto it = s.begin();
cout << *it << "\n";
```

Iterators can be moved using the operators `++` (forward) and `--` (backward), meaning that the iterator moves to the next or previous element in the set.

The following code prints all the elements in increasing order:

```
for (auto it = s.begin(); it != s.end(); it++) {
    cout << *it << "\n";
}
```

The following code prints the largest element in the set:

```
auto it = s.end(); it--;
cout << *it << "\n";
```

The function `find(x)` returns an iterator that points to an element whose value is  $x$ . However, if the set does not contain  $x$ , the iterator will be `end`.

```
auto it = s.find(x);
if (it == s.end()) {
    // x is not found
}
```

The function `lower_bound(x)` returns an iterator to the smallest element in the set whose value is *at least*  $x$ , and the function `upper_bound(x)` returns an iterator to the smallest element in the set whose value is *larger than*  $x$ . In both functions, if such an element does not exist, the return value is `end`. These functions are not supported by the `unordered_set` structure which does not maintain the order of the elements.

For example, the following code finds the element nearest to  $x$ :

```
auto it = s.lower_bound(x);
if (it == s.begin()) {
    cout << *it << "\n";
} else if (it == s.end()) {
    it--;
    cout << *it << "\n";
} else {
    int a = *it; it--;
    int b = *it;
    if (x-b < a-x) cout << b << "\n";
    else cout << a << "\n";
}
```

The code assumes that the set is not empty, and goes through all possible cases using an iterator  $it$ . First, the iterator points to the smallest element whose value is at least  $x$ . If it equals  $begin$ , the corresponding element is nearest to  $x$ . If it equals  $end$ , the largest element in the set is nearest to  $x$ . If none of the previous cases hold, the element nearest to  $x$  is either the element that corresponds to  $it$  or the previous element.

## 4.5 Other structures

### Bitset

A **bitset** is an array whose each value is either 0 or 1. For example, the following code creates a **bitset** that contains 10 elements:

```
bitset<10> s;
s[1] = 1;
s[3] = 1;
s[4] = 1;
s[7] = 1;
cout << s[4] << "\n"; // 1
cout << s[5] << "\n"; // 0
```

The benefit of using bitsets is that they require less memory than ordinary arrays, because each element in a **bitset** only uses one bit of memory. For example, if  $n$  bits are stored in an `int` array,  $32n$  bits of memory will be used, but a corresponding **bitset** only requires  $n$  bits of memory. In addition, the values of a **bitset** can be efficiently manipulated using bit operators, which makes it possible to optimize algorithms using bit sets.

The following code shows another way to create the above **bitset**:

```
bitset<10> s(string("0010011010")); // from right to left
cout << s[4] << "\n"; // 1
cout << s[5] << "\n"; // 0
```

The function `count` returns the number of ones in the bitset:

```
bitset<10> s(string("0010011010"));
cout << s.count() << "\n"; // 4
```

The following code shows examples of using bit operations:

```
bitset<10> a(string("0010110110"));
bitset<10> b(string("1011011000"));
cout << (a&b) << "\n"; // 0010010000
cout << (a|b) << "\n"; // 1011111110
cout << (a^b) << "\n"; // 1001101110
```

## Deque

A **deque** is a dynamic array whose size can be efficiently changed at both ends of the array. Like a vector, a deque provides the functions `push_back` and `pop_back`, but it also includes the functions `push_front` and `pop_front` which are not available in a vector.

A deque can be used as follows:

```
deque<int> d;
d.push_back(5); // [5]
d.push_back(2); // [5,2]
d.push_front(3); // [3,5,2]
d.pop_back(); // [3,5]
d.pop_front(); // [5]
```

The internal implementation of a deque is more complex than that of a vector, and for this reason, a deque is slower than a vector. Still, both adding and removing elements take  $O(1)$  time on average at both ends.

## Stack

A **stack** is a data structure that provides two  $O(1)$  time operations: adding an element to the top, and removing an element from the top. It is only possible to access the top element of a stack.

The following code shows how a stack can be used:

```
stack<int> s;
s.push(3);
s.push(2);
s.push(5);
cout << s.top(); // 5
s.pop();
cout << s.top(); // 2
```

## Queue

A **queue** also provides two  $O(1)$  time operations: adding an element to the end of the queue, and removing the first element in the queue. It is only possible to access the first and last element of a queue.

The following code shows how a queue can be used:

```
queue<int> q;
q.push(3);
q.push(2);
q.push(5);
cout << q.front(); // 3
q.pop();
cout << q.front(); // 2
```

## Priority queue

A **priority queue** maintains a set of elements. The supported operations are insertion and, depending on the type of the queue, retrieval and removal of either the minimum or maximum element. Insertion and removal take  $O(\log n)$  time, and retrieval takes  $O(1)$  time.

While an ordered set efficiently supports all the operations of a priority queue, the benefit of using a priority queue is that it has smaller constant factors. A priority queue is usually implemented using a heap structure that is much simpler than a balanced binary tree used in an ordered set.

By default, the elements in a C++ priority queue are sorted in decreasing order, and it is possible to find and remove the largest element in the queue. The following code illustrates this:

```
priority_queue<int> q;
q.push(3);
q.push(5);
q.push(7);
q.push(2);
cout << q.top() << "\n"; // 7
q.pop();
cout << q.top() << "\n"; // 5
q.pop();
q.push(6);
cout << q.top() << "\n"; // 6
q.pop();
```

If we want to create a priority queue that supports finding and removing the smallest element, we can do it as follows:

```
priority_queue<int, vector<int>, greater<int>> q;
```

## Policy-based data structures

The g++ compiler also supports some data structures that are not part of the C++ standard library. Such structures are called *policy-based* data structures. To use these structures, the following lines must be added to the code:

```
#include <ext/pb_ds/assoc_container.hpp>
using namespace __gnu_pbds;
```

After this, we can define a data structure `indexed_set` that is like `set` but can be indexed like an array. The definition for `int` values is as follows:

```
typedef tree<int,null_type,less<int>,rb_tree_tag,
           tree_order_statistics_node_update> indexed_set;
```

Now we can create a set as follows:

```
indexed_set s;
s.insert(2);
s.insert(3);
s.insert(7);
s.insert(9);
```

The speciality of this set is that we have access to the indices that the elements would have in a sorted array. The function `find_by_order` returns an iterator to the element at a given position:

```
auto x = s.find_by_order(2);
cout << *x << "\n"; // 7
```

And the function `order_of_key` returns the position of a given element:

```
cout << s.order_of_key(7) << "\n"; // 2
```

If the element does not appear in the set, we get the position that the element would have in the set:

```
cout << s.order_of_key(6) << "\n"; // 2
cout << s.order_of_key(8) << "\n"; // 3
```

Both the functions work in logarithmic time.

## 4.6 Comparison to sorting

It is often possible to solve a problem using either data structures or sorting. Sometimes there are remarkable differences in the actual efficiency of these approaches, which may be hidden in their time complexities.

Let us consider a problem where we are given two lists *A* and *B* that both contain *n* elements. Our task is to calculate the number of elements that belong

to both of the lists. For example, for the lists

$$A = [5, 2, 8, 9, 4] \quad \text{and} \quad B = [3, 2, 9, 5],$$

the answer is 3 because the numbers 2, 5 and 9 belong to both of the lists.

A straightforward solution to the problem is to go through all pairs of elements in  $O(n^2)$  time, but next we will focus on more efficient algorithms.

## Algorithm 1

We construct a set of the elements that appear in  $A$ , and after this, we iterate through the elements of  $B$  and check for each elements if it also belongs to  $A$ . This is efficient because the elements of  $A$  are in a set. Using the set structure, the time complexity of the algorithm is  $O(n \log n)$ .

## Algorithm 2

It is not necessary to maintain an ordered set, so instead of the set structure we can also use the `unordered_set` structure. This is an easy way to make the algorithm more efficient, because we only have to change the underlying data structure. The time complexity of the new algorithm is  $O(n)$ .

## Algorithm 3

Instead of data structures, we can use sorting. First, we sort both lists  $A$  and  $B$ . After this, we iterate through both the lists at the same time and find the common elements. The time complexity of sorting is  $O(n \log n)$ , and the rest of the algorithm works in  $O(n)$  time, so the total time complexity is  $O(n \log n)$ .

## Efficiency comparison

The following table shows how efficient the above algorithms are when  $n$  varies and the elements of the lists are random integers between  $1 \dots 10^9$ :

| $n$            | Algorithm 1 | Algorithm 2 | Algorithm 3 |
|----------------|-------------|-------------|-------------|
| $10^6$         | 1.5 s       | 0.3 s       | 0.2 s       |
| $2 \cdot 10^6$ | 3.7 s       | 0.8 s       | 0.3 s       |
| $3 \cdot 10^6$ | 5.7 s       | 1.3 s       | 0.5 s       |
| $4 \cdot 10^6$ | 7.7 s       | 1.7 s       | 0.7 s       |
| $5 \cdot 10^6$ | 10.0 s      | 2.3 s       | 0.9 s       |

Algorithms 1 and 2 are equal except that they use different set structures. In this problem, this choice has an important effect on the running time, because Algorithm 2 is 4–5 times faster than Algorithm 1.

However, the most efficient algorithm is Algorithm 3 which uses sorting. It only uses half the time compared to Algorithm 2. Interestingly, the time complexity of both Algorithm 1 and Algorithm 3 is  $O(n \log n)$ , but despite this, Algorithm 3 is ten times faster. This can be explained by the fact that sorting is a

simple procedure and it is done only once at the beginning of Algorithm 3, and the rest of the algorithm works in linear time. On the other hand, Algorithm 1 maintains a complex balanced binary tree during the whole algorithm.



# Chapter 5

## Complete search

**Complete search** is a general method that can be used to solve almost any algorithm problem. The idea is to generate all possible solutions to the problem using brute force, and then select the best solution or count the number of solutions, depending on the problem.

Complete search is a good technique if there is enough time to go through all the solutions, because the search is usually easy to implement and it always gives the correct answer. If complete search is too slow, other techniques, such as greedy algorithms or dynamic programming, may be needed.

### 5.1 Generating subsets

We first consider the problem of generating all subsets of a set of  $n$  elements. For example, the subsets of  $\{0, 1, 2\}$  are  $\emptyset$ ,  $\{0\}$ ,  $\{1\}$ ,  $\{2\}$ ,  $\{0, 1\}$ ,  $\{0, 2\}$ ,  $\{1, 2\}$  and  $\{0, 1, 2\}$ . There are two common methods to generate subsets: we can either perform a recursive search or exploit the bit representation of integers.

#### Method 1

An elegant way to go through all subsets of a set is to use recursion. The following function `search` generates the subsets of the set  $\{0, 1, \dots, n - 1\}$ . The function maintains a vector `subset` that will contain the elements of each subset. The search begins when the function is called with parameter `0`.

```
void search(int k) {
    if (k == n) {
        // process subset
    } else {
        search(k+1);
        subset.push_back(k);
        search(k+1);
        subset.pop_back();
    }
}
```

When the function `search` is called with parameter  $k$ , it decides whether to include the element  $k$  in the subset or not, and in both cases, then calls itself with parameter  $k + 1$ . However, if  $k = n$ , the function notices that all elements have been processed and a subset has been generated.

The following tree illustrates the function calls when  $n = 3$ . We can always choose either the left branch ( $k$  is not included in the subset) or the right branch ( $k$  is included in the subset).

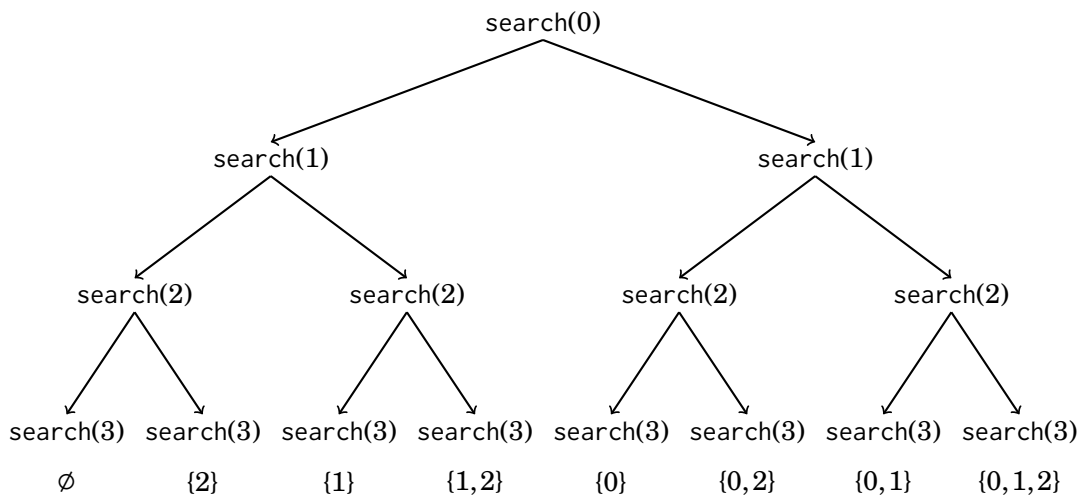

## Method 2

Another way to generate subsets is based on the bit representation of integers. Each subset of a set of  $n$  elements can be represented as a sequence of  $n$  bits, which corresponds to an integer between  $0 \dots 2^n - 1$ . The ones in the bit sequence indicate which elements are included in the subset.

The usual convention is that the last bit corresponds to element 0, the second last bit corresponds to element 1, and so on. For example, the bit representation of 25 is 11001, which corresponds to the subset  $\{0, 3, 4\}$ .

The following code goes through the subsets of a set of  $n$  elements

```

for (int b = 0; b < (1<<n); b++) {
    // process subset
}

```

The following code shows how we can find the elements of a subset that corresponds to a bit sequence. When processing each subset, the code builds a vector that contains the elements in the subset.

```

for (int b = 0; b < (1<<n); b++) {
    vector<int> subset;
    for (int i = 0; i < n; i++) {
        if (b & (1<<i)) subset.push_back(i);
    }
}

```

## 5.2 Generating permutations

Next we consider the problem of generating all permutations of a set of  $n$  elements. For example, the permutations of  $\{0, 1, 2\}$  are  $(0, 1, 2)$ ,  $(0, 2, 1)$ ,  $(1, 0, 2)$ ,  $(1, 2, 0)$ ,  $(2, 0, 1)$  and  $(2, 1, 0)$ . Again, there are two approaches: we can either use recursion or go through the permutations iteratively.

### Method 1

Like subsets, permutations can be generated using recursion. The following function `search` goes through the permutations of the set  $\{0, 1, \dots, n - 1\}$ . The function builds a vector permutation that contains the permutation, and the search begins when the function is called without parameters.

```
void search() {
    if (permutation.size() == n) {
        // process permutation
    } else {
        for (int i = 0; i < n; i++) {
            if (chosen[i]) continue;
            chosen[i] = true;
            permutation.push_back(i);
            search();
            chosen[i] = false;
            permutation.pop_back();
        }
    }
}
```

Each function call adds a new element to permutation. The array `chosen` indicates which elements are already included in the permutation. If the size of permutation equals the size of the set, a permutation has been generated.

### Method 2

Another method for generating permutations is to begin with the permutation  $\{0, 1, \dots, n - 1\}$  and repeatedly use a function that constructs the next permutation in increasing order. The C++ standard library contains the function `next_permutation` that can be used for this:

```
vector<int> permutation;
for (int i = 0; i < n; i++) {
    permutation.push_back(i);
}
do {
    // process permutation
} while (next_permutation(permutation.begin(), permutation.end()));
```

## 5.3 Backtracking

A **backtracking** algorithm begins with an empty solution and extends the solution step by step. The search recursively goes through all different ways how a solution can be constructed.

As an example, consider the problem of calculating the number of ways  $n$  queens can be placed to an  $n \times n$  chessboard so that no two queens attack each other. For example, when  $n = 4$ , there are two possible solutions:

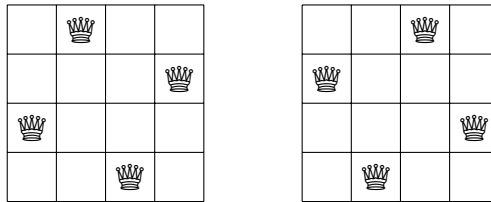

The problem can be solved using backtracking by placing queens to the board row by row. More precisely, exactly one queen will be placed to each row so that no queen attacks any of the queens placed before. A solution has been found when all  $n$  queens have been placed to the board.

For example, when  $n = 4$ , some partial solutions generated by the backtracking algorithm are as follows:

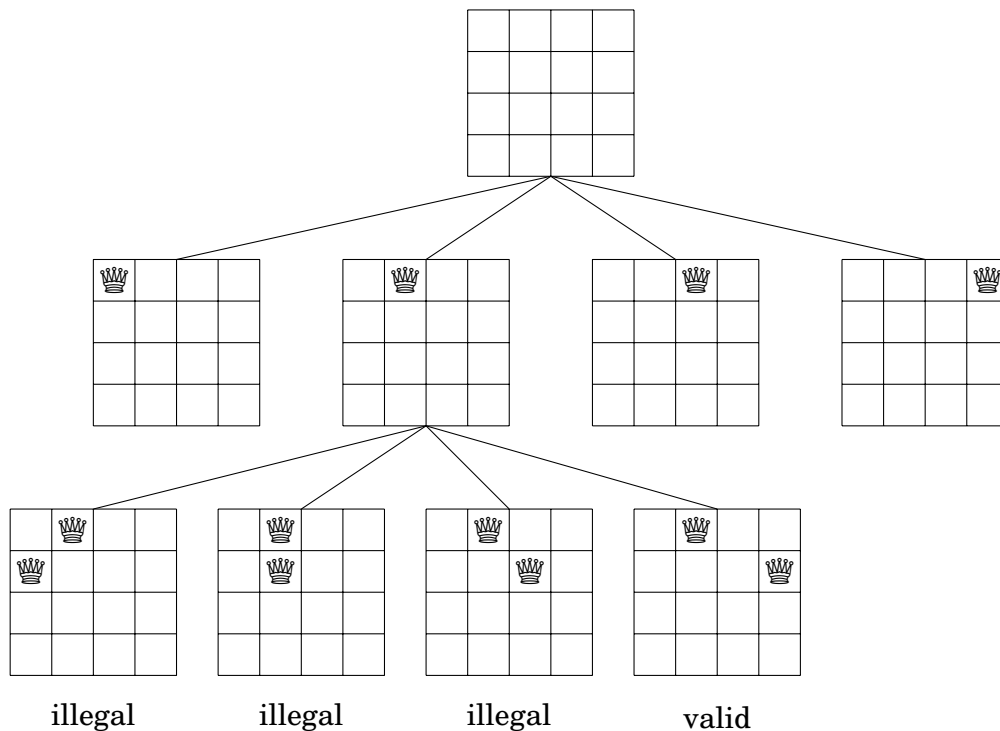

At the bottom level, the three first configurations are illegal, because the queens attack each other. However, the fourth configuration is valid and it can be extended to a complete solution by placing two more queens to the board. There is only one way to place the two remaining queens.

The algorithm can be implemented as follows:

```

void search(int y) {
    if (y == n) {
        count++;
        return;
    }
    for (int x = 0; x < n; x++) {
        if (column[x] || diag1[x+y] || diag2[x-y+n-1]) continue;
        column[x] = diag1[x+y] = diag2[x-y+n-1] = 1;
        search(y+1);
        column[x] = diag1[x+y] = diag2[x-y+n-1] = 0;
    }
}

```

The search begins by calling `search(0)`. The size of the board is  $n$ , and the code calculates the number of solutions to count.

The code assumes that the rows and columns of the board are numbered from 0 to  $n - 1$ . When the function `search` is called with parameter  $y$ , it places a queen to row  $y$  and then calls itself with parameter  $y + 1$ . Then, if  $y = n$ , a solution has been found and the variable `count` is increased by one.

The array `column` keeps track of columns that contain a queen, and the arrays `diag1` and `diag2` keep track of diagonals. It is not allowed to add another queen to a column or diagonal that already contains a queen. For example, the columns and diagonals of the  $4 \times 4$  board are numbered as follows:

|   |   |   |   |
|---|---|---|---|
| 0 | 1 | 2 | 3 |
| 0 | 1 | 2 | 3 |
| 0 | 1 | 2 | 3 |
| 0 | 1 | 2 | 3 |

column

|   |   |   |   |
|---|---|---|---|
| 0 | 1 | 2 | 3 |
| 1 | 2 | 3 | 4 |
| 2 | 3 | 4 | 5 |
| 3 | 4 | 5 | 6 |

diag1

|   |   |   |   |
|---|---|---|---|
| 3 | 4 | 5 | 6 |
| 2 | 3 | 4 | 5 |
| 1 | 2 | 3 | 4 |
| 0 | 1 | 2 | 3 |

diag2

Let  $q(n)$  denote the number of ways to place  $n$  queens to an  $n \times n$  chessboard. The above backtracking algorithm tells us that, for example,  $q(8) = 92$ . When  $n$  increases, the search quickly becomes slow, because the number of the solutions increases exponentially. For example, calculating  $q(16) = 14772512$  using the above algorithm already takes about a minute on a modern computer<sup>1</sup>.

## 5.4 Pruning the search

We can often optimize backtracking by pruning the search tree. The idea is to add "intelligence" to the algorithm so that it will notice as soon as possible if a partial solution cannot be extended to a complete solution. Such optimizations can have a tremendous effect on the efficiency of the search.

<sup>1</sup>There is no known way to efficiently calculate larger values of  $q(n)$ . The current record is  $q(27) = 234907967154122528$ , calculated in 2016 [56].

Let us consider the problem of calculating the number of paths in an  $n \times n$  grid from the upper-left corner to the lower-right corner such that the path visits each square exactly once. For example, in a  $7 \times 7$  grid, there are 111712 such paths. One of the paths is as follows:

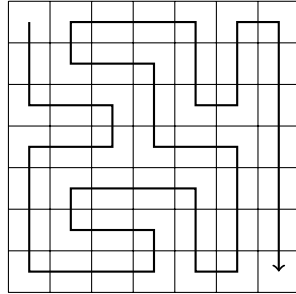

We focus on the  $7 \times 7$  case, because its level of difficulty is appropriate to our needs. We begin with a straightforward backtracking algorithm, and then optimize it step by step using observations of how the search can be pruned. After each optimization, we measure the running time of the algorithm and the number of recursive calls, so that we clearly see the effect of each optimization on the efficiency of the search.

## Basic algorithm

The first version of the algorithm does not contain any optimizations. We simply use backtracking to generate all possible paths from the upper-left corner to the lower-right corner and count the number of such paths.

- running time: 483 seconds
- number of recursive calls: 76 billion

## Optimization 1

In any solution, we first move one step down or right. There are always two paths that are symmetric about the diagonal of the grid after the first step. For example, the following paths are symmetric:

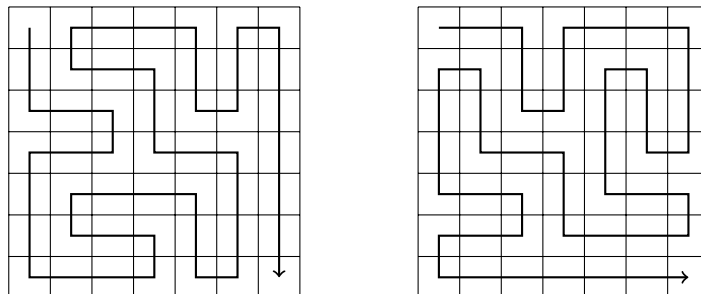

Hence, we can decide that we always first move one step down (or right), and finally multiply the number of solutions by two.

- running time: 244 seconds
- number of recursive calls: 38 billion

## Optimization 2

If the path reaches the lower-right square before it has visited all other squares of the grid, it is clear that it will not be possible to complete the solution. An example of this is the following path:

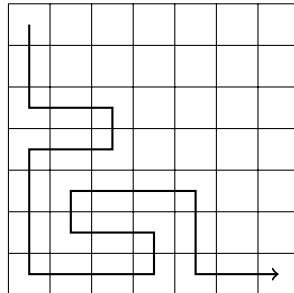

Using this observation, we can terminate the search immediately if we reach the lower-right square too early.

- running time: 119 seconds
- number of recursive calls: 20 billion

## Optimization 3

If the path touches a wall and can turn either left or right, the grid splits into two parts that contain unvisited squares. For example, in the following situation, the path can turn either left or right:

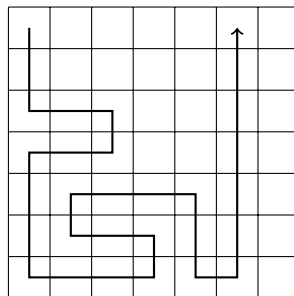

In this case, we cannot visit all squares anymore, so we can terminate the search. This optimization is very useful:

- running time: 1.8 seconds
- number of recursive calls: 221 million

## Optimization 4

The idea of Optimization 3 can be generalized: if the path cannot continue forward but can turn either left or right, the grid splits into two parts that both contain unvisited squares. For example, consider the following path:

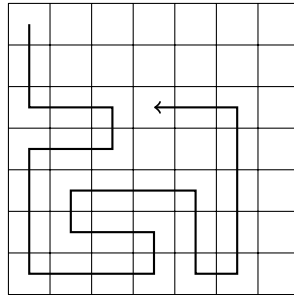

It is clear that we cannot visit all squares anymore, so we can terminate the search. After this optimization, the search is very efficient:

- running time: 0.6 seconds
- number of recursive calls: 69 million

Now is a good moment to stop optimizing the algorithm and see what we have achieved. The running time of the original algorithm was 483 seconds, and now after the optimizations, the running time is only 0.6 seconds. Thus, the algorithm became nearly 1000 times faster after the optimizations.

This is a usual phenomenon in backtracking, because the search tree is usually large and even simple observations can effectively prune the search. Especially useful are optimizations that occur during the first steps of the algorithm, i.e., at the top of the search tree.

## 5.5 Meet in the middle

**Meet in the middle** is a technique where the search space is divided into two parts of about equal size. A separate search is performed for both of the parts, and finally the results of the searches are combined.

The technique can be used if there is an efficient way to combine the results of the searches. In such a situation, the two searches may require less time than one large search. Typically, we can turn a factor of  $2^n$  into a factor of  $2^{n/2}$  using the meet in the middle technique.

As an example, consider a problem where we are given a list of  $n$  numbers and a number  $x$ , and we want to find out if it is possible to choose some numbers from the list so that their sum is  $x$ . For example, given the list  $[2, 4, 5, 9]$  and  $x = 15$ , we can choose the numbers  $[2, 4, 9]$  to get  $2 + 4 + 9 = 15$ . However, if  $x = 10$  for the same list, it is not possible to form the sum.

A simple algorithm to the problem is to go through all subsets of the elements and check if the sum of any of the subsets is  $x$ . The running time of such an algorithm is  $O(2^n)$ , because there are  $2^n$  subsets. However, using the meet in the middle technique, we can achieve a more efficient  $O(2^{n/2})$  time algorithm<sup>2</sup>. Note that  $O(2^n)$  and  $O(2^{n/2})$  are different complexities because  $2^{n/2}$  equals  $\sqrt{2^n}$ .

<sup>2</sup>This idea was introduced in 1974 by E. Horowitz and S. Sahni [39].



The idea is to divide the list into two lists  $A$  and  $B$  such that both lists contain about half of the numbers. The first search generates all subsets of  $A$  and stores their sums to a list  $S_A$ . Correspondingly, the second search creates a list  $S_B$  from  $B$ . After this, it suffices to check if it is possible to choose one element from  $S_A$  and another element from  $S_B$  such that their sum is  $x$ . This is possible exactly when there is a way to form the sum  $x$  using the numbers of the original list.

For example, suppose that the list is  $[2, 4, 5, 9]$  and  $x = 15$ . First, we divide the list into  $A = [2, 4]$  and  $B = [5, 9]$ . After this, we create lists  $S_A = [0, 2, 4, 6]$  and  $S_B = [0, 5, 9, 14]$ . In this case, the sum  $x = 15$  is possible to form, because  $S_A$  contains the sum 6,  $S_B$  contains the sum 9, and  $6 + 9 = 15$ . This corresponds to the solution  $[2, 4, 9]$ .

The time complexity of the algorithm is  $O(2^{n/2})$ , because both lists  $A$  and  $B$  contain about  $n/2$  numbers and it takes  $O(2^{n/2})$  time to calculate the sums of their subsets to lists  $S_A$  and  $S_B$ . After this, it is possible to check in  $O(2^{n/2})$  time if the sum  $x$  can be created from  $S_A$  and  $S_B$ .



# Chapter 6

## Greedy algorithms

A **greedy algorithm** constructs a solution to the problem by always making a choice that looks the best at the moment. A greedy algorithm never takes back its choices, but directly constructs the final solution. For this reason, greedy algorithms are usually very efficient.

The difficulty in designing greedy algorithms is to find a greedy strategy that always produces an optimal solution to the problem. The locally optimal choices in a greedy algorithm should also be globally optimal. It is often difficult to argue that a greedy algorithm works.

### 6.1 Coin problem

As a first example, we consider a problem where we are given a set of coins and our task is to form a sum of money  $n$  using the coins. The values of the coins are  $\text{coins} = \{c_1, c_2, \dots, c_k\}$ , and each coin can be used as many times we want. What is the minimum number of coins needed?

For example, if the coins are the euro coins (in cents)

$$\{1, 2, 5, 10, 20, 50, 100, 200\}$$

and  $x = 520$ , we need at least four coins. The optimal solution is to select coins  $200 + 200 + 100 + 20$  whose sum is 520.

#### Greedy algorithm

A simple greedy algorithm to the problem always selects the largest possible coin, until the required sum of money has been constructed. This algorithm works in the example case, because we first select two 200 cent coins, then one 100 cent coin and finally one 20 cent coin. But does this algorithm always work?

It turns out that if the coins are the euro coins, the greedy algorithm *always* works, i.e., it always produces a solution with the fewest possible number of coins. The correctness of the algorithm can be shown as follows:

First, each coin 1, 5, 10, 50 and 100 appears at most once in an optimal solution, because if the solution would contain two such coins, we could replace

them by one coin and obtain a better solution. For example, if the solution would contain coins  $5 + 5$ , we could replace them by coin 10.

In the same way, coins 2 and 20 appear at most twice in an optimal solution, because we could replace coins  $2 + 2 + 2$  by coins  $5 + 1$  and coins  $20 + 20 + 20$  by coins  $50 + 10$ . Moreover, an optimal solution cannot contain coins  $2 + 2 + 1$  or  $20 + 20 + 10$ , because we could replace them by coins 5 and 50.

Using these observations, we can show for each coin  $x$  that it is not possible to optimally construct a sum  $x$  or any larger sum by only using coins that are smaller than  $x$ . For example, if  $x = 100$ , the largest optimal sum using the smaller coins is  $50 + 20 + 20 + 5 + 2 + 2 = 99$ . Thus, the greedy algorithm that always selects the largest coin produces the optimal solution.

This example shows that it can be difficult to argue that a greedy algorithm works, even if the algorithm itself is simple.

## General case

In the general case, the coin set can contain any coins and the greedy algorithm *does not* necessarily produce an optimal solution.

We can prove that a greedy algorithm does not work by showing a counterexample where the algorithm gives a wrong answer. In this problem we can easily find a counterexample: if the coins are  $\{1, 3, 4\}$  and the target sum is 6, the greedy algorithm produces the solution  $4 + 1 + 1$  while the optimal solution is  $3 + 3$ .

It is not known if the general coin problem can be solved using any greedy algorithm<sup>1</sup>. However, as we will see in Chapter 7, in some cases, the general problem can be efficiently solved using a dynamic programming algorithm that always gives the correct answer.

## 6.2 Scheduling

Many scheduling problems can be solved using greedy algorithms. A classic problem is as follows: Given  $n$  events with their starting and ending times, find a schedule that includes as many events as possible. It is not possible to select an event partially. For example, consider the following events:

| event    | starting time | ending time |
|----------|---------------|-------------|
| <i>A</i> | 1             | 3           |
| <i>B</i> | 2             | 5           |
| <i>C</i> | 3             | 9           |
| <i>D</i> | 6             | 8           |

In this case the maximum number of events is two. For example, we can select events *B* and *D* as follows:

---

<sup>1</sup>However, it is possible to *check* in polynomial time if the greedy algorithm presented in this chapter works for a given set of coins [54].

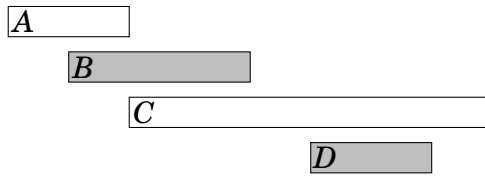

It is possible to invent several greedy algorithms for the problem, but which of them works in every case?

### Algorithm 1

The first idea is to select as *short* events as possible. In the example case this algorithm selects the following events:

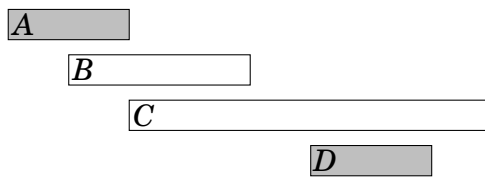

However, selecting short events is not always a correct strategy. For example, the algorithm fails in the following case:

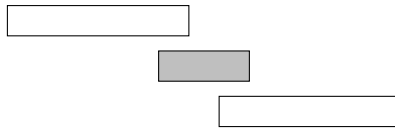

If we select the short event, we can only select one event. However, it would be possible to select both long events.

### Algorithm 2

Another idea is to always select the next possible event that *begins as early* as possible. This algorithm selects the following events:

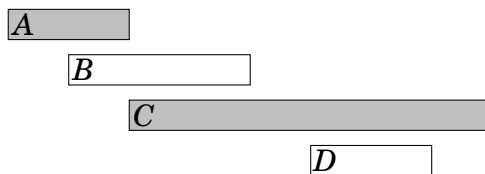

However, we can find a counterexample also for this algorithm. For example, in the following case, the algorithm only selects one event:

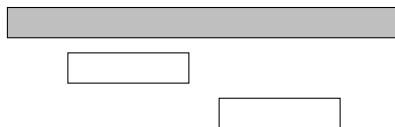

If we select the first event, it is not possible to select any other events. However, it would be possible to select the other two events.

### Algorithm 3

The third idea is to always select the next possible event that *ends* as *early* as possible. This algorithm selects the following events:

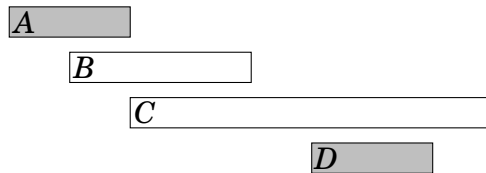

It turns out that this algorithm *always* produces an optimal solution. The reason for this is that it is always an optimal choice to first select an event that ends as early as possible. After this, it is an optimal choice to select the next event using the same strategy, etc., until we cannot select any more events.

One way to argue that the algorithm works is to consider what happens if we first select an event that ends later than the event that ends as early as possible. Now, we will have at most an equal number of choices how we can select the next event. Hence, selecting an event that ends later can never yield a better solution, and the greedy algorithm is correct.

## 6.3 Tasks and deadlines

Let us now consider a problem where we are given  $n$  tasks with durations and deadlines and our task is to choose an order to perform the tasks. For each task, we earn  $d - x$  points where  $d$  is the task's deadline and  $x$  is the moment when we finish the task. What is the largest possible total score we can obtain?

For example, suppose that the tasks are as follows:

| task     | duration | deadline |
|----------|----------|----------|
| <i>A</i> | 4        | 2        |
| <i>B</i> | 3        | 5        |
| <i>C</i> | 2        | 7        |
| <i>D</i> | 4        | 5        |

In this case, an optimal schedule for the tasks is as follows:

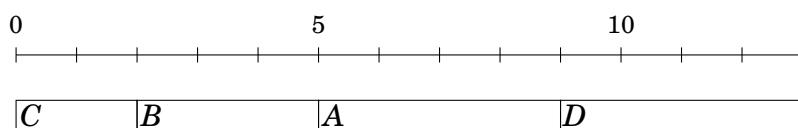

In this solution, *C* yields 5 points, *B* yields 0 points, *A* yields  $-7$  points and *D* yields  $-8$  points, so the total score is  $-10$ .

Surprisingly, the optimal solution to the problem does not depend on the deadlines at all, but a correct greedy strategy is to simply perform the tasks *sorted by their durations* in increasing order. The reason for this is that if we ever perform two tasks one after another such that the first task takes longer than the second task, we can obtain a better solution if we swap the tasks. For example, consider the following schedule:

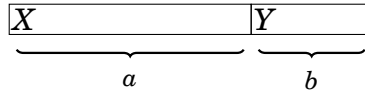

Here  $a > b$ , so we should swap the tasks:

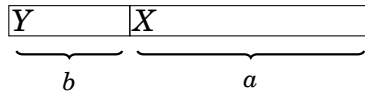

Now  $X$  gives  $b$  points less and  $Y$  gives  $a$  points more, so the total score increases by  $a - b > 0$ . In an optimal solution, for any two consecutive tasks, it must hold that the shorter task comes before the longer task. Thus, the tasks must be performed sorted by their durations.

## 6.4 Minimizing sums

We next consider a problem where we are given  $n$  numbers  $a_1, a_2, \dots, a_n$  and our task is to find a value  $x$  that minimizes the sum

$$|a_1 - x|^c + |a_2 - x|^c + \dots + |a_n - x|^c.$$

We focus on the cases  $c = 1$  and  $c = 2$ .

### Case $c = 1$

In this case, we should minimize the sum

$$|a_1 - x| + |a_2 - x| + \dots + |a_n - x|.$$

For example, if the numbers are  $[1, 2, 9, 2, 6]$ , the best solution is to select  $x = 2$  which produces the sum

$$|1 - 2| + |2 - 2| + |9 - 2| + |2 - 2| + |6 - 2| = 12.$$

In the general case, the best choice for  $x$  is the *median* of the numbers, i.e., the middle number after sorting. For example, the list  $[1, 2, 9, 2, 6]$  becomes  $[1, 2, 2, 6, 9]$  after sorting, so the median is 2.

The median is an optimal choice, because if  $x$  is smaller than the median, the sum becomes smaller by increasing  $x$ , and if  $x$  is larger than the median, the sum becomes smaller by decreasing  $x$ . Hence, the optimal solution is that  $x$  is the median. If  $n$  is even and there are two medians, both medians and all values between them are optimal choices.

### Case $c = 2$

In this case, we should minimize the sum

$$(a_1 - x)^2 + (a_2 - x)^2 + \dots + (a_n - x)^2.$$

For example, if the numbers are [1,2,9,2,6], the best solution is to select  $x = 4$  which produces the sum

$$(1 - 4)^2 + (2 - 4)^2 + (9 - 4)^2 + (2 - 4)^2 + (6 - 4)^2 = 46.$$

In the general case, the best choice for  $x$  is the *average* of the numbers. In the example the average is  $(1 + 2 + 9 + 2 + 6)/5 = 4$ . This result can be derived by presenting the sum as follows:

$$nx^2 - 2x(a_1 + a_2 + \dots + a_n) + (a_1^2 + a_2^2 + \dots + a_n^2)$$

The last part does not depend on  $x$ , so we can ignore it. The remaining parts form a function  $nx^2 - 2xs$  where  $s = a_1 + a_2 + \dots + a_n$ . This is a parabola opening upwards with roots  $x = 0$  and  $x = 2s/n$ , and the minimum value is the average of the roots  $x = s/n$ , i.e., the average of the numbers  $a_1, a_2, \dots, a_n$ .

## 6.5 Data compression

A **binary code** assigns for each character of a string a **codeword** that consists of bits. We can *compress* the string using the binary code by replacing each character by the corresponding codeword. For example, the following binary code assigns codewords for characters A–D:

| character | codeword |
|-----------|----------|
| A         | 00       |
| B         | 01       |
| C         | 10       |
| D         | 11       |

This is a **constant-length** code which means that the length of each codeword is the same. For example, we can compress the string AABACDACA as follows:

000001001011001000

Using this code, the length of the compressed string is 18 bits. However, we can compress the string better if we use a **variable-length** code where codewords may have different lengths. Then we can give short codewords for characters that appear often and long codewords for characters that appear rarely. It turns out that an **optimal** code for the above string is as follows:

| character | codeword |
|-----------|----------|
| A         | 0        |
| B         | 110      |
| C         | 10       |
| D         | 111      |

An optimal code produces a compressed string that is as short as possible. In this case, the compressed string using the optimal code is

001100101110100,



so only 15 bits are needed instead of 18 bits. Thus, thanks to a better code it was possible to save 3 bits in the compressed string.

We require that no codeword is a prefix of another codeword. For example, it is not allowed that a code would contain both codewords 10 and 1011. The reason for this is that we want to be able to generate the original string from the compressed string. If a codeword could be a prefix of another codeword, this would not always be possible. For example, the following code is *not* valid:

| character | codeword |
|-----------|----------|
| A         | 10       |
| B         | 11       |
| C         | 1011     |
| D         | 111      |

Using this code, it would not be possible to know if the compressed string 1011 corresponds to the string AB or the string C.

## Huffman coding

**Huffman coding**<sup>2</sup> is a greedy algorithm that constructs an optimal code for compressing a given string. The algorithm builds a binary tree based on the frequencies of the characters in the string, and each character's codeword can be read by following a path from the root to the corresponding node. A move to the left corresponds to bit 0, and a move to the right corresponds to bit 1.

Initially, each character of the string is represented by a node whose weight is the number of times the character occurs in the string. Then at each step two nodes with minimum weights are combined by creating a new node whose weight is the sum of the weights of the original nodes. The process continues until all nodes have been combined.

Next we will see how Huffman coding creates the optimal code for the string AABACDAC. Initially, there are four nodes that correspond to the characters of the string:

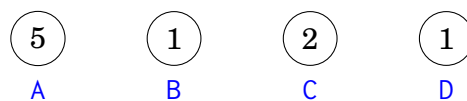

The node that represents character A has weight 5 because character A appears 5 times in the string. The other weights have been calculated in the same way.

The first step is to combine the nodes that correspond to characters B and D, both with weight 1. The result is:

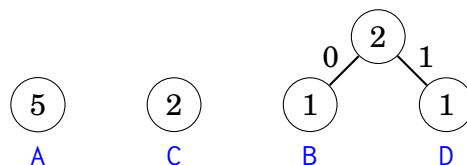

<sup>2</sup>D. A. Huffman discovered this method when solving a university course assignment and published the algorithm in 1952 [40].

After this, the nodes with weight 2 are combined:

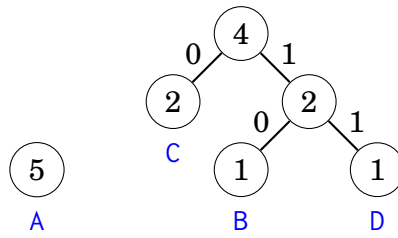

Finally, the two remaining nodes are combined:

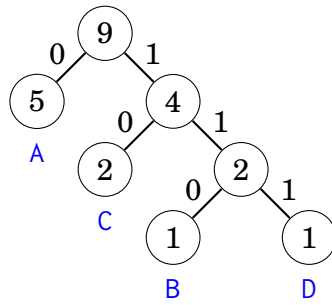

Now all nodes are in the tree, so the code is ready. The following codewords can be read from the tree:

| character | codeword |
|-----------|----------|
| A         | 0        |
| B         | 110      |
| C         | 10       |
| D         | 111      |

# Chapter 7

## Dynamic programming

**Dynamic programming** is a technique that combines the correctness of complete search and the efficiency of greedy algorithms. Dynamic programming can be applied if the problem can be divided into overlapping subproblems that can be solved independently.

There are two uses for dynamic programming:

- **Finding an optimal solution:** We want to find a solution that is as large as possible or as small as possible.
- **Counting the number of solutions:** We want to calculate the total number of possible solutions.

We will first see how dynamic programming can be used to find an optimal solution, and then we will use the same idea for counting the solutions.

Understanding dynamic programming is a milestone in every competitive programmer's career. While the basic idea is simple, the challenge is how to apply dynamic programming to different problems. This chapter introduces a set of classic problems that are a good starting point.

### 7.1 Coin problem

We first focus on a problem that we have already seen in Chapter 6: Given a set of coin values  $\text{coins} = \{c_1, c_2, \dots, c_k\}$  and a target sum of money  $n$ , our task is to form the sum  $n$  using as few coins as possible.

In Chapter 6, we solved the problem using a greedy algorithm that always chooses the largest possible coin. The greedy algorithm works, for example, when the coins are the euro coins, but in the general case the greedy algorithm does not necessarily produce an optimal solution.

Now is time to solve the problem efficiently using dynamic programming, so that the algorithm works for any coin set. The dynamic programming algorithm is based on a recursive function that goes through all possibilities how to form the sum, like a brute force algorithm. However, the dynamic programming algorithm is efficient because it uses *memoization* and calculates the answer to each subproblem only once.

## Recursive formulation

The idea in dynamic programming is to formulate the problem recursively so that the solution to the problem can be calculated from solutions to smaller subproblems. In the coin problem, a natural recursive problem is as follows: what is the smallest number of coins required to form a sum  $x$ ?

Let  $\text{solve}(x)$  denote the minimum number of coins required for a sum  $x$ . The values of the function depend on the values of the coins. For example, if  $\text{coins} = \{1, 3, 4\}$ , the first values of the function are as follows:

$$\begin{aligned}\text{solve}(0) &= 0 \\ \text{solve}(1) &= 1 \\ \text{solve}(2) &= 2 \\ \text{solve}(3) &= 1 \\ \text{solve}(4) &= 1 \\ \text{solve}(5) &= 2 \\ \text{solve}(6) &= 2 \\ \text{solve}(7) &= 2 \\ \text{solve}(8) &= 2 \\ \text{solve}(9) &= 3 \\ \text{solve}(10) &= 3\end{aligned}$$

For example,  $\text{solve}(10) = 3$ , because at least 3 coins are needed to form the sum 10. The optimal solution is  $3 + 3 + 4 = 10$ .

The essential property of  $\text{solve}$  is that its values can be recursively calculated from its smaller values. The idea is to focus on the *first* coin that we choose for the sum. For example, in the above scenario, the first coin can be either 1, 3 or 4. If we first choose coin 1, the remaining task is to form the sum 9 using the minimum number of coins, which is a subproblem of the original problem. Of course, the same applies to coins 3 and 4. Thus, we can use the following recursive formula to calculate the minimum number of coins:

$$\begin{aligned}\text{solve}(x) = \min(\text{solve}(x - 1) + 1, \\ \text{solve}(x - 3) + 1, \\ \text{solve}(x - 4) + 1).\end{aligned}$$

The base case of the recursion is  $\text{solve}(0) = 0$ , because no coins are needed to form an empty sum. For example,

$$\text{solve}(10) = \text{solve}(7) + 1 = \text{solve}(4) + 2 = \text{solve}(0) + 3 = 3.$$

Now we are ready to give a general recursive function that calculates the minimum number of coins needed to form a sum  $x$ :

$$\text{solve}(x) = \begin{cases} \infty & x < 0 \\ 0 & x = 0 \\ \min_{c \in \text{coins}} \text{solve}(x - c) + 1 & x > 0 \end{cases}$$

First, if  $x < 0$ , the value is  $\infty$ , because it is impossible to form a negative sum of money. Then, if  $x = 0$ , the value is 0, because no coins are needed to form an

empty sum. Finally, if  $x > 0$ , the variable  $c$  goes through all possibilities how to choose the first coin of the sum.

Once a recursive function that solves the problem has been found, we can directly implement a solution in C++ (the constant INF denotes infinity):

```
int solve(int x) {
    if (x < 0) return INF;
    if (x == 0) return 0;
    int best = INF;
    for (auto c : coins) {
        best = min(best, solve(x-c)+1);
    }
    return best;
}
```

Still, this function is not efficient, because there may be an exponential number of ways to construct the sum. However, next we will see how to make the function efficient using a technique called memoization.

## Using memoization

The idea of dynamic programming is to use **memoization** to efficiently calculate values of a recursive function. This means that the values of the function are stored in an array after calculating them. For each parameter, the value of the function is calculated recursively only once, and after this, the value can be directly retrieved from the array.

In this problem, we use arrays

```
bool ready[N];
int value[N];
```

where  $ready[x]$  indicates whether the value of  $solve(x)$  has been calculated, and if it is,  $value[x]$  contains this value. The constant  $N$  has been chosen so that all required values fit in the arrays.

Now the function can be efficiently implemented as follows:

```
int solve(int x) {
    if (x < 0) return INF;
    if (x == 0) return 0;
    if (ready[x]) return value[x];
    int best = INF;
    for (auto c : coins) {
        best = min(best, solve(x-c)+1);
    }
    value[x] = best;
    ready[x] = true;
    return best;
}
```

The function handles the base cases  $x < 0$  and  $x = 0$  as previously. Then the function checks from `ready[x]` if `solve(x)` has already been stored in `value[x]`, and if it is, the function directly returns it. Otherwise the function calculates the value of `solve(x)` recursively and stores it in `value[x]`.

This function works efficiently, because the answer for each parameter  $x$  is calculated recursively only once. After a value of `solve(x)` has been stored in `value[x]`, it can be efficiently retrieved whenever the function will be called again with the parameter  $x$ . The time complexity of the algorithm is  $O(nk)$ , where  $n$  is the target sum and  $k$  is the number of coins.

Note that we can also *iteratively* construct the array `value` using a loop that simply calculates all the values of `solve` for parameters  $0 \dots n$ :

```
value[0] = 0;
for (int x = 1; x <= n; x++) {
    value[x] = INF;
    for (auto c : coins) {
        if (x-c >= 0) {
            value[x] = min(value[x], value[x-c]+1);
        }
    }
}
```

In fact, most competitive programmers prefer this implementation, because it is shorter and has lower constant factors. From now on, we also use iterative implementations in our examples. Still, it is often easier to think about dynamic programming solutions in terms of recursive functions.

## Constructing a solution

Sometimes we are asked both to find the value of an optimal solution and to give an example how such a solution can be constructed. In the coin problem, for example, we can declare another array that indicates for each sum of money the first coin in an optimal solution:

```
int first[N];
```

Then, we can modify the algorithm as follows:

```
value[0] = 0;
for (int x = 1; x <= n; x++) {
    value[x] = INF;
    for (auto c : coins) {
        if (x-c >= 0 && value[x-c]+1 < value[x]) {
            value[x] = value[x-c]+1;
            first[x] = c;
        }
    }
}
```

After this, the following code can be used to print the coins that appear in an optimal solution for the sum  $n$ :

```
while (n > 0) {
    cout << first[n] << "\n";
    n -= first[n];
}
```

## Counting the number of solutions

Let us now consider another version of the coin problem where our task is to calculate the total number of ways to produce a sum  $x$  using the coins. For example, if  $\text{coins} = \{1, 3, 4\}$  and  $x = 5$ , there are a total of 6 ways:

- $1+1+1+1+1$
- $1+1+3$
- $1+3+1$
- $3+1+1$
- $1+4$
- $4+1$

Again, we can solve the problem recursively. Let  $\text{solve}(x)$  denote the number of ways we can form the sum  $x$ . For example, if  $\text{coins} = \{1, 3, 4\}$ , then  $\text{solve}(5) = 6$  and the recursive formula is

$$\begin{aligned} \text{solve}(x) = & \text{solve}(x-1) + \\ & \text{solve}(x-3) + \\ & \text{solve}(x-4). \end{aligned}$$

Then, the general recursive function is as follows:

$$\text{solve}(x) = \begin{cases} 0 & x < 0 \\ 1 & x = 0 \\ \sum_{c \in \text{coins}} \text{solve}(x-c) & x > 0 \end{cases}$$

If  $x < 0$ , the value is 0, because there are no solutions. If  $x = 0$ , the value is 1, because there is only one way to form an empty sum. Otherwise we calculate the sum of all values of the form  $\text{solve}(x-c)$  where  $c$  is in  $\text{coins}$ .

The following code constructs an array  $\text{count}$  such that  $\text{count}[x]$  equals the value of  $\text{solve}(x)$  for  $0 \leq x \leq n$ :

```
count[0] = 1;
for (int x = 1; x <= n; i++) {
    for (auto c : coins) {
        if (x-c >= 0) {
            count[x] += count[x-c];
        }
    }
}
```

Often the number of solutions is so large that it is not required to calculate the exact number but it is enough to give the answer modulo  $m$  where, for example,  $m = 10^9 + 7$ . This can be done by changing the code so that all calculations are done modulo  $m$ . In the above code, it suffices to add the line

```
count[x] %= m;
```

after the line

```
count[x] += count[x-c];
```

Now we have discussed all basic ideas of dynamic programming. Since dynamic programming can be used in many different situations, we will now go through a set of problems that show further examples about the possibilities of dynamic programming.

## 7.2 Longest increasing subsequence

Our first problem is to find the **longest increasing subsequence** in an array of  $n$  elements. This is a maximum-length sequence of array elements that goes from left to right, and each element in the sequence is larger than the previous element. For example, in the array

|   |   |   |   |   |   |   |   |
|---|---|---|---|---|---|---|---|
| 0 | 1 | 2 | 3 | 4 | 5 | 6 | 7 |
| 6 | 2 | 5 | 1 | 7 | 4 | 8 | 3 |

the longest increasing subsequence contains 4 elements:

|   |   |   |   |   |   |   |   |
|---|---|---|---|---|---|---|---|
| 0 | 1 | 2 | 3 | 4 | 5 | 6 | 7 |
| 6 | 2 | 5 | 1 | 7 | 4 | 8 | 3 |



Let  $\text{length}(k)$  denote the length of the longest increasing subsequence that ends at position  $k$ . Thus, if we calculate all values of  $\text{length}(k)$  where  $0 \leq k \leq n-1$ , we will find out the length of the longest increasing subsequence. For example, the values of the function for the above array are as follows:

```
length(0) = 1
length(1) = 1
length(2) = 2
length(3) = 1
length(4) = 3
length(5) = 2
length(6) = 4
length(7) = 2
```

For example,  $\text{length}(6) = 4$ , because the longest increasing subsequence that ends at position 6 consists of 4 elements.



To calculate a value of  $\text{length}(k)$ , we should find a position  $i < k$  for which  $\text{array}[i] < \text{array}[k]$  and  $\text{length}(i)$  is as large as possible. Then we know that  $\text{length}(k) = \text{length}(i) + 1$ , because this is an optimal way to add  $\text{array}[k]$  to a subsequence. However, if there is no such position  $i$ , then  $\text{length}(k) = 1$ , which means that the subsequence only contains  $\text{array}[k]$ .

Since all values of the function can be calculated from its smaller values, we can use dynamic programming. In the following code, the values of the function will be stored in an array `length`.

```
for (int k = 0; k < n; k++) {
    length[k] = 1;
    for (int i = 0; i < k; i++) {
        if (array[i] < array[k]) {
            length[k] = max(length[k], length[i]+1);
        }
    }
}
```

This code works in  $O(n^2)$  time, because it consists of two nested loops. However, it is also possible to implement the dynamic programming calculation more efficiently in  $O(n \log n)$  time. Can you find a way to do this?

## 7.3 Paths in a grid

Our next problem is to find a path from the upper-left corner to the lower-right corner of an  $n \times n$  grid, such that we only move down and right. Each square contains a positive integer, and the path should be constructed so that the sum of the values along the path is as large as possible.

The following picture shows an optimal path in a grid:

|   |   |   |   |    |
|---|---|---|---|----|
| 3 | 7 | 9 | 2 | 7  |
| 9 | 8 | 3 | 5 | 5  |
| 1 | 7 | 9 | 8 | 5  |
| 3 | 8 | 6 | 4 | 10 |
| 6 | 3 | 9 | 7 | 8  |

The sum of the values on the path is 67, and this is the largest possible sum on a path from the upper-left corner to the lower-right corner.

Assume that the rows and columns of the grid are numbered from 1 to  $n$ , and  $\text{value}[y][x]$  equals the value of square  $(y, x)$ . Let  $\text{sum}(y, x)$  denote the maximum sum on a path from the upper-left corner to square  $(y, x)$ . Now  $\text{sum}(n, n)$  tells us the maximum sum from the upper-left corner to the lower-right corner. For example, in the above grid,  $\text{sum}(5, 5) = 67$ .

We can recursively calculate the sums as follows:

$$\text{sum}(y, x) = \max(\text{sum}(y, x - 1), \text{sum}(y - 1, x)) + \text{value}[y][x]$$

The recursive formula is based on the observation that a path that ends at square  $(y, x)$  can come either from square  $(y, x - 1)$  or square  $(y - 1, x)$ :

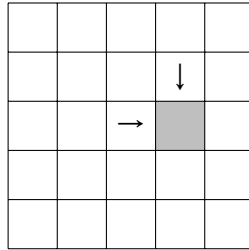

Thus, we select the direction that maximizes the sum. We assume that  $\text{sum}(y, x) = 0$  if  $y = 0$  or  $x = 0$  (because no such paths exist), so the recursive formula also works when  $y = 1$  or  $x = 1$ .

Since the function  $\text{sum}$  has two parameters, the dynamic programming array also has two dimensions. For example, we can use an array

```
int sum[N][N];
```

and calculate the sums as follows:

```
for (int y = 1; y <= n; y++) {
    for (int x = 1; x <= n; x++) {
        sum[y][x] = max(sum[y][x-1], sum[y-1][x]) + value[y][x];
    }
}
```

The time complexity of the algorithm is  $O(n^2)$ .

## 7.4 Knapsack problems

The term **knapsack** refers to problems where a set of objects is given, and subsets with some properties have to be found. Knapsack problems can often be solved using dynamic programming.

In this section, we focus on the following problem: Given a list of weights  $[w_1, w_2, \dots, w_n]$ , determine all sums that can be constructed using the weights. For example, if the weights are  $[1, 3, 3, 5]$ , the following sums are possible:

|   |   |   |   |   |   |   |   |   |   |    |    |    |
|---|---|---|---|---|---|---|---|---|---|----|----|----|
| 0 | 1 | 2 | 3 | 4 | 5 | 6 | 7 | 8 | 9 | 10 | 11 | 12 |
| X | X |   | X | X | X | X | X | X | X |    | X  | X  |

In this case, all sums between  $0 \dots 12$  are possible, except 2 and 10. For example, the sum 7 is possible because we can select the weights  $[1, 3, 3]$ .

To solve the problem, we focus on subproblems where we only use the first  $k$  weights to construct sums. Let  $\text{possible}(x, k) = \text{true}$  if we can construct a sum  $x$  using the first  $k$  weights, and otherwise  $\text{possible}(x, k) = \text{false}$ . The values of the function can be recursively calculated as follows:

$$\text{possible}(x, k) = \text{possible}(x - w_k, k - 1) \vee \text{possible}(x, k - 1)$$

The formula is based on the fact that we can either use or not use the weight  $w_k$  in the sum. If we use  $w_k$ , the remaining task is to form the sum  $x - w_k$  using the first  $k - 1$  weights, and if we do not use  $w_k$ , the remaining task is to form the sum  $x$  using the first  $k - 1$  weights. As the base cases,

$$\text{possible}(x,0) = \begin{cases} \text{true} & x = 0 \\ \text{false} & x \neq 0 \end{cases}$$

because if no weights are used, we can only form the sum 0.

The following table shows all values of the function for the weights [1,3,3,5] (the symbol "X" indicates the true values):

| $k \backslash x$ | 0 | 1 | 2 | 3 | 4 | 5 | 6 | 7 | 8 | 9 | 10 | 11 | 12 |
|------------------|---|---|---|---|---|---|---|---|---|---|----|----|----|
| 0                | X |   |   |   |   |   |   |   |   |   |    |    |    |
| 1                | X | X |   |   |   |   |   |   |   |   |    |    |    |
| 2                | X | X |   | X | X |   |   |   |   |   |    |    |    |
| 3                | X | X |   | X | X |   | X | X |   |   |    |    |    |
| 4                | X | X |   | X | X | X | X | X | X | X |    | X  | X  |

After calculating those values,  $\text{possible}(x,n)$  tells us whether we can construct a sum  $x$  using *all* weights.

Let  $W$  denote the total sum of the weights. The following  $O(nW)$  time dynamic programming solution corresponds to the recursive function:

```
possible[0][0] = true;
for (int k = 1; k <= n; k++) {
    for (int x = 0; x <= W; x++) {
        if (x-w[k] >= 0) possible[x][k] |= possible[x-w[k]][k-1];
        possible[x][k] |= possible[x][k-1];
    }
}
```

However, here is a better implementation that only uses a one-dimensional array  $\text{possible}[x]$  that indicates whether we can construct a subset with sum  $x$ . The trick is to update the array from right to left for each new weight:

```
possible[0] = true;
for (int k = 1; k <= n; k++) {
    for (int x = W; x >= 0; x--) {
        if (possible[x]) possible[x+w[k]] = true;
    }
}
```

Note that the general idea presented here can be used in many knapsack problems. For example, if we are given objects with weights and values, we can determine for each weight sum the maximum value sum of a subset.

## 7.5 Edit distance

The **edit distance** or **Levenshtein distance**<sup>1</sup> is the minimum number of editing operations needed to transform a string into another string. The allowed editing operations are as follows:

- insert a character (e.g. ABC → ABCA)
- remove a character (e.g. ABC → AC)
- modify a character (e.g. ABC → ADC)

For example, the edit distance between LOVE and MOVIE is 2, because we can first perform the operation LOVE → MOVE (modify) and then the operation MOVE → MOVIE (insert). This is the smallest possible number of operations, because it is clear that only one operation is not enough.

Suppose that we are given a string  $x$  of length  $n$  and a string  $y$  of length  $m$ , and we want to calculate the edit distance between  $x$  and  $y$ . To solve the problem, we define a function  $\text{distance}(a, b)$  that gives the edit distance between prefixes  $x[0..a]$  and  $y[0..b]$ . Thus, using this function, the edit distance between  $x$  and  $y$  equals  $\text{distance}(n-1, m-1)$ .

We can calculate values of  $\text{distance}$  as follows:

$$\begin{aligned} \text{distance}(a, b) = \min(\text{distance}(a, b-1) + 1, \\ \text{distance}(a-1, b) + 1, \\ \text{distance}(a-1, b-1) + \text{cost}(a, b)). \end{aligned}$$

Here  $\text{cost}(a, b) = 0$  if  $x[a] = y[b]$ , and otherwise  $\text{cost}(a, b) = 1$ . The formula considers the following ways to edit the string  $x$ :

- $\text{distance}(a, b-1)$ : insert a character at the end of  $x$
- $\text{distance}(a-1, b)$ : remove the last character from  $x$
- $\text{distance}(a-1, b-1)$ : match or modify the last character of  $x$

In the two first cases, one editing operation is needed (insert or remove). In the last case, if  $x[a] = y[b]$ , we can match the last characters without editing, and otherwise one editing operation is needed (modify).

The following table shows the values of  $\text{distance}$  in the example case:

|   |   | M | O | V | I | E |
|---|---|---|---|---|---|---|
|   | 0 | 1 | 2 | 3 | 4 | 5 |
| L | 1 | 1 | 2 | 3 | 4 | 5 |
| O | 2 | 2 | 1 | 2 | 3 | 4 |
| V | 3 | 3 | 2 | 1 | 2 | 3 |
| E | 4 | 4 | 3 | 2 | 2 | 2 |

<sup>1</sup>The distance is named after V. I. Levenshtein who studied it in connection with binary codes [49].

The lower-right corner of the table tells us that the edit distance between LOVE and MOVIE is 2. The table also shows how to construct the shortest sequence of editing operations. In this case the path is as follows:

|   |   | M | O | V | I | E |
|---|---|---|---|---|---|---|
| L | 0 | 1 | 2 | 3 | 4 | 5 |
| O | 1 | 1 | 2 | 3 | 4 | 5 |
| V | 2 | 2 | 1 | 2 | 3 | 4 |
| I | 3 | 3 | 2 | 1 | 2 | 3 |
| E | 4 | 4 | 3 | 2 | 2 | 2 |

The last characters of LOVE and MOVIE are equal, so the edit distance between them equals the edit distance between LOV and MOVI. We can use one editing operation to remove the character I from MOVI. Thus, the edit distance is one larger than the edit distance between LOV and MOV, etc.

## 7.6 Counting tilings

Sometimes the states of a dynamic programming solution are more complex than fixed combinations of numbers. As an example, consider the problem of calculating the number of distinct ways to fill an  $n \times m$  grid using  $1 \times 2$  and  $2 \times 1$  size tiles. For example, one valid solution for the  $4 \times 7$  grid is

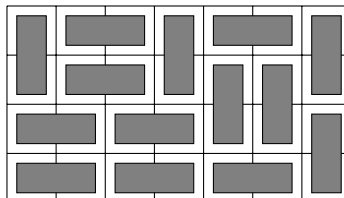

and the total number of solutions is 781.

The problem can be solved using dynamic programming by going through the grid row by row. Each row in a solution can be represented as a string that contains  $m$  characters from the set  $\{\sqcup, \sqcup, \sqcup, \sqcup\}$ . For example, the above solution consists of four rows that correspond to the following strings:

- $\sqcup \sqcup \sqcup \sqcup \sqcup \sqcup \sqcup$
- $\sqcup \sqcup \sqcup \sqcup \sqcup \sqcup \sqcup$
- $\sqcup \sqcup \sqcup \sqcup \sqcup \sqcup \sqcup$
- $\sqcup \sqcup \sqcup \sqcup \sqcup \sqcup \sqcup$

Let  $\text{count}(k, x)$  denote the number of ways to construct a solution for rows  $1 \dots k$  of the grid such that string  $x$  corresponds to row  $k$ . It is possible to use dynamic programming here, because the state of a row is constrained only by the state of the previous row.

A solution is valid if row 1 does not contain the character  $\sqcup$ , row  $n$  does not contain the character  $\sqcap$ , and all consecutive rows are *compatible*. For example, the rows  $\sqcup \sqsubset \sqsupset \sqcup \sqcap \sqcup$  and  $\sqsubset \sqsubset \sqsubset \sqcup \sqcup \sqcap$  are compatible, while the rows  $\sqcap \sqsubset \sqsubset \sqcap \sqsubset \sqcap$  and  $\sqsubset \sqsubset \sqsubset \sqsubset \sqcup$  are not compatible.

Since a row consists of  $m$  characters and there are four choices for each character, the number of distinct rows is at most  $4^m$ . Thus, the time complexity of the solution is  $O(n4^{2m})$  because we can go through the  $O(4^m)$  possible states for each row, and for each state, there are  $O(4^m)$  possible states for the previous row. In practice, it is a good idea to rotate the grid so that the shorter side has length  $m$ , because the factor  $4^{2m}$  dominates the time complexity.

It is possible to make the solution more efficient by using a more compact representation for the rows. It turns out that it is sufficient to know which columns of the previous row contain the upper square of a vertical tile. Thus, we can represent a row using only characters  $\sqcap$  and  $\square$ , where  $\square$  is a combination of characters  $\sqcup$ ,  $\sqsubset$  and  $\sqsupset$ . Using this representation, there are only  $2^m$  distinct rows and the time complexity is  $O(n2^{2m})$ .

As a final note, there is also a surprising direct formula for calculating the number of tilings<sup>2</sup>:

$$\prod_{a=1}^{\lceil n/2 \rceil} \prod_{b=1}^{\lceil m/2 \rceil} 4 \cdot \left( \cos^2 \frac{\pi a}{n+1} + \cos^2 \frac{\pi b}{m+1} \right)$$

This formula is very efficient, because it calculates the number of tilings in  $O(nm)$  time, but since the answer is a product of real numbers, a problem when using the formula is how to store the intermediate results accurately.

---

<sup>2</sup>Surprisingly, this formula was discovered in 1961 by two research teams [43, 67] that worked independently.

# Chapter 8

## Amortized analysis

The time complexity of an algorithm is often easy to analyze just by examining the structure of the algorithm: what loops does the algorithm contain and how many times the loops are performed. However, sometimes a straightforward analysis does not give a true picture of the efficiency of the algorithm.

**Amortized analysis** can be used to analyze algorithms that contain operations whose time complexity varies. The idea is to estimate the total time used to all such operations during the execution of the algorithm, instead of focusing on individual operations.

### 8.1 Two pointers method

In the **two pointers method**, two pointers are used to iterate through the array values. Both pointers can move to one direction only, which ensures that the algorithm works efficiently. Next we discuss two problems that can be solved using the two pointers method.

#### Subarray sum

As the first example, consider a problem where we are given an array of  $n$  positive integers and a target sum  $x$ , and we want to find a subarray whose sum is  $x$  or report that there is no such subarray.

For example, the array

|   |   |   |   |   |   |   |   |
|---|---|---|---|---|---|---|---|
| 1 | 3 | 2 | 5 | 1 | 1 | 2 | 3 |
|---|---|---|---|---|---|---|---|

contains a subarray whose sum is 8:

|   |   |   |   |   |   |   |   |
|---|---|---|---|---|---|---|---|
| 1 | 3 | 2 | 5 | 1 | 1 | 2 | 3 |
|---|---|---|---|---|---|---|---|

This problem can be solved in  $O(n)$  time by using the two pointers method. The idea is to maintain pointers that point to the first and last value of a subarray. On each turn, the left pointer moves one step to the right, and the right pointer moves to the right as long as the resulting subarray sum is at most  $x$ . If the sum becomes exactly  $x$ , a solution has been found.

As an example, consider the following array and a target sum  $x = 8$ :

|   |   |   |   |   |   |   |   |
|---|---|---|---|---|---|---|---|
| 1 | 3 | 2 | 5 | 1 | 1 | 2 | 3 |
|---|---|---|---|---|---|---|---|

The initial subarray contains the values 1, 3 and 2 whose sum is 6:

|   |   |   |   |   |   |   |   |
|---|---|---|---|---|---|---|---|
| 1 | 3 | 2 | 5 | 1 | 1 | 2 | 3 |
|---|---|---|---|---|---|---|---|

↑            ↑

Then, the left pointer moves one step to the right. The right pointer does not move, because otherwise the subarray sum would exceed  $x$ .

|   |   |   |   |   |   |   |   |
|---|---|---|---|---|---|---|---|
| 1 | 3 | 2 | 5 | 1 | 1 | 2 | 3 |
|---|---|---|---|---|---|---|---|

      ↑        ↑

Again, the left pointer moves one step to the right, and this time the right pointer moves three steps to the right. The subarray sum is  $2 + 5 + 1 = 8$ , so a subarray whose sum is  $x$  has been found.

|   |   |   |   |   |   |   |   |
|---|---|---|---|---|---|---|---|
| 1 | 3 | 2 | 5 | 1 | 1 | 2 | 3 |
|---|---|---|---|---|---|---|---|

          ↑        ↑

The running time of the algorithm depends on the number of steps the right pointer moves. While there is no useful upper bound on how many steps the pointer can move on a *single* turn, we know that the pointer moves *a total of*  $O(n)$  steps during the algorithm, because it only moves to the right.

Since both the left and right pointer move  $O(n)$  steps during the algorithm, the algorithm works in  $O(n)$  time.

## 2SUM problem

Another problem that can be solved using the two pointers method is the following problem, also known as the **2SUM problem**: given an array of  $n$  numbers and a target sum  $x$ , find two array values such that their sum is  $x$ , or report that no such values exist.

To solve the problem, we first sort the array values in increasing order. After that, we iterate through the array using two pointers. The left pointer starts at the first value and moves one step to the right on each turn. The right pointer begins at the last value and always moves to the left until the sum of the left and right value is at most  $x$ . If the sum is exactly  $x$ , a solution has been found.

For example, consider the following array and a target sum  $x = 12$ :

|   |   |   |   |   |   |   |    |
|---|---|---|---|---|---|---|----|
| 1 | 4 | 5 | 6 | 7 | 9 | 9 | 10 |
|---|---|---|---|---|---|---|----|

The initial positions of the pointers are as follows. The sum of the values is  $1 + 10 = 11$  that is smaller than  $x$ .



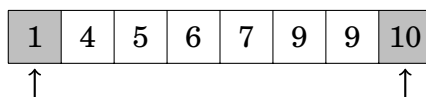

Then the left pointer moves one step to the right. The right pointer moves three steps to the left, and the sum becomes  $4 + 7 = 11$ .

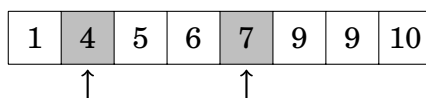

After this, the left pointer moves one step to the right again. The right pointer does not move, and a solution  $5 + 7 = 12$  has been found.

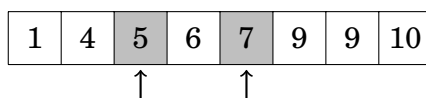

The running time of the algorithm is  $O(n \log n)$ , because it first sorts the array in  $O(n \log n)$  time, and then both pointers move  $O(n)$  steps.

Note that it is possible to solve the problem in another way in  $O(n \log n)$  time using binary search. In such a solution, we iterate through the array and for each array value, we try to find another value that yields the sum  $x$ . This can be done by performing  $n$  binary searches, each of which takes  $O(\log n)$  time.

A more difficult problem is the **3SUM problem** that asks to find *three* array values whose sum is  $x$ . Using the idea of the above algorithm, this problem can be solved in  $O(n^2)$  time<sup>1</sup>. Can you see how?

## 8.2 Nearest smaller elements

Amortized analysis is often used to estimate the number of operations performed on a data structure. The operations may be distributed unevenly so that most operations occur during a certain phase of the algorithm, but the total number of the operations is limited.

As an example, consider the problem of finding for each array element the **nearest smaller element**, i.e., the first smaller element that precedes the element in the array. It is possible that no such element exists, in which case the algorithm should report this. Next we will see how the problem can be efficiently solved using a stack structure.

We go through the array from left to right and maintain a stack of array elements. At each array position, we remove elements from the stack until the top element is smaller than the current element, or the stack is empty. Then, we report that the top element is the nearest smaller element of the current element, or if the stack is empty, there is no such element. Finally, we add the current element to the stack.

As an example, consider the following array:

<sup>1</sup>For a long time, it was thought that solving the 3SUM problem more efficiently than in  $O(n^2)$  time would not be possible. However, in 2014, it turned out [30] that this is not the case.

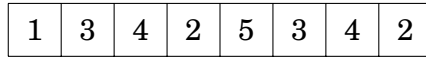

First, the elements 1, 3 and 4 are added to the stack, because each element is larger than the previous element. Thus, the nearest smaller element of 4 is 3, and the nearest smaller element of 3 is 1.

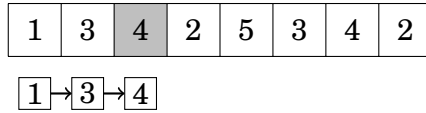

The next element 2 is smaller than the two top elements in the stack. Thus, the elements 3 and 4 are removed from the stack, and then the element 2 is added to the stack. Its nearest smaller element is 1:

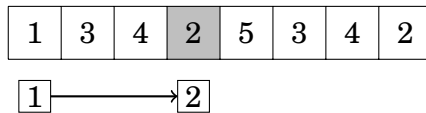

Then, the element 5 is larger than the element 2, so it will be added to the stack, and its nearest smaller element is 2:

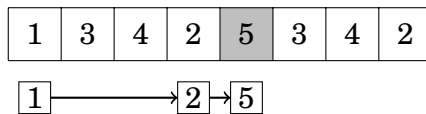

After this, the element 5 is removed from the stack and the elements 3 and 4 are added to the stack:

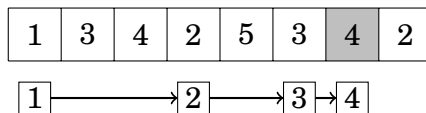

Finally, all elements except 1 are removed from the stack and the last element 2 is added to the stack:

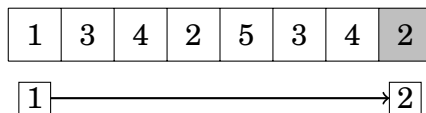

The efficiency of the algorithm depends on the total number of stack operations. If the current element is larger than the top element in the stack, it is directly added to the stack, which is efficient. However, sometimes the stack can contain several larger elements and it takes time to remove them. Still, each element is added *exactly once* to the stack and removed *at most once* from the stack. Thus, each element causes  $O(1)$  stack operations, and the algorithm works in  $O(n)$  time.

## 8.3 Sliding window minimum

A **sliding window** is a constant-size subarray that moves from left to right through the array. At each window position, we want to calculate some information about the elements inside the window. In this section, we focus on the problem of maintaining the **sliding window minimum**, which means that we should report the smallest value inside each window.

The sliding window minimum can be calculated using a similar idea that we used to calculate the nearest smaller elements. We maintain a queue where each element is larger than the previous element, and the first element always corresponds to the minimum element inside the window. After each window move, we remove elements from the end of the queue until the last queue element is smaller than the new window element, or the queue becomes empty. We also remove the first queue element if it is not inside the window anymore. Finally, we add the new window element to the end of the queue.

As an example, consider the following array:

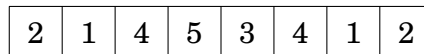

Suppose that the size of the sliding window is 4. At the first window position, the smallest value is 1:

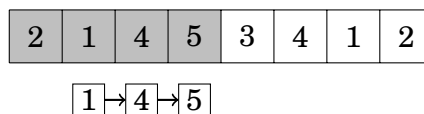

Then the window moves one step right. The new element 3 is smaller than the elements 4 and 5 in the queue, so the elements 4 and 5 are removed from the queue and the element 3 is added to the queue. The smallest value is still 1.

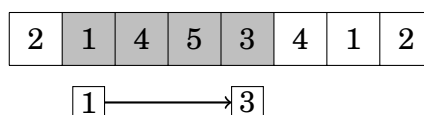

After this, the window moves again, and the smallest element 1 does not belong to the window anymore. Thus, it is removed from the queue and the smallest value is now 3. Also the new element 4 is added to the queue.

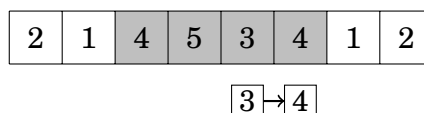

The next new element 1 is smaller than all elements in the queue. Thus, all elements are removed from the queue and it will only contain the element 1:

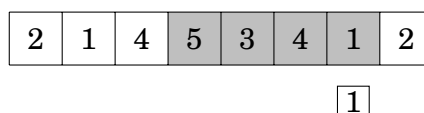

Finally the window reaches its last position. The element 2 is added to the queue, but the smallest value inside the window is still 1.

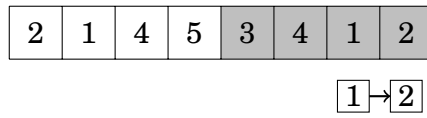

Since each array element is added to the queue exactly once and removed from the queue at most once, the algorithm works in  $O(n)$  time.

# Chapter 9

## Range queries

In this chapter, we discuss data structures that allow us to efficiently process range queries. In a **range query**, our task is to calculate a value based on a subarray of an array. Typical range queries are:

- $\text{sum}_q(a, b)$ : calculate the sum of values in range  $[a, b]$
- $\text{min}_q(a, b)$ : find the minimum value in range  $[a, b]$
- $\text{max}_q(a, b)$ : find the maximum value in range  $[a, b]$

For example, consider the range  $[3, 6]$  in the following array:

|   |   |   |   |   |   |   |   |
|---|---|---|---|---|---|---|---|
| 0 | 1 | 2 | 3 | 4 | 5 | 6 | 7 |
| 1 | 3 | 8 | 4 | 6 | 1 | 3 | 4 |

In this case,  $\text{sum}_q(3, 6) = 14$ ,  $\text{min}_q(3, 6) = 1$  and  $\text{max}_q(3, 6) = 6$ .

A simple way to process range queries is to use a loop that goes through all array values in the range. For example, the following function can be used to process sum queries on an array:

```
int sum(int a, int b) {
    int s = 0;
    for (int i = a; i <= b; i++) {
        s += array[i];
    }
    return s;
}
```

This function works in  $O(n)$  time, where  $n$  is the size of the array. Thus, we can process  $q$  queries in  $O(nq)$  time using the function. However, if both  $n$  and  $q$  are large, this approach is slow. Fortunately, it turns out that there are ways to process range queries much more efficiently.

## 9.1 Static array queries

We first focus on a situation where the array is *static*, i.e., the array values are never updated between the queries. In this case, it suffices to construct a static data structure that tells us the answer for any possible query.

### Sum queries

We can easily process sum queries on a static array by constructing a **prefix sum array**. Each value in the prefix sum array equals the sum of values in the original array up to that position, i.e., the value at position  $k$  is  $\text{sum}_q(0, k)$ . The prefix sum array can be constructed in  $O(n)$  time.

For example, consider the following array:

| 0 | 1 | 2 | 3 | 4 | 5 | 6 | 7 |
|---|---|---|---|---|---|---|---|
| 1 | 3 | 4 | 8 | 6 | 1 | 4 | 2 |

The corresponding prefix sum array is as follows:

| 0 | 1 | 2 | 3  | 4  | 5  | 6  | 7  |
|---|---|---|----|----|----|----|----|
| 1 | 4 | 8 | 16 | 22 | 23 | 27 | 29 |

Since the prefix sum array contains all values of  $\text{sum}_q(0, k)$ , we can calculate any value of  $\text{sum}_q(a, b)$  in  $O(1)$  time as follows:

$$\text{sum}_q(a, b) = \text{sum}_q(0, b) - \text{sum}_q(0, a - 1)$$

By defining  $\text{sum}_q(0, -1) = 0$ , the above formula also holds when  $a = 0$ .

For example, consider the range  $[3, 6]$ :

| 0 | 1 | 2 | 3 | 4 | 5 | 6 | 7 |
|---|---|---|---|---|---|---|---|
| 1 | 3 | 4 | 8 | 6 | 1 | 4 | 2 |

In this case  $\text{sum}_q(3, 6) = 8 + 6 + 1 + 4 = 19$ . This sum can be calculated from two values of the prefix sum array:

| 0 | 1 | 2 | 3  | 4  | 5  | 6  | 7  |
|---|---|---|----|----|----|----|----|
| 1 | 4 | 8 | 16 | 22 | 23 | 27 | 29 |

Thus,  $\text{sum}_q(3, 6) = \text{sum}_q(0, 6) - \text{sum}_q(0, 2) = 27 - 8 = 19$ .

It is also possible to generalize this idea to higher dimensions. For example, we can construct a two-dimensional prefix sum array that can be used to calculate the sum of any rectangular subarray in  $O(1)$  time. Each sum in such an array corresponds to a subarray that begins at the upper-left corner of the array.

The following picture illustrates the idea:

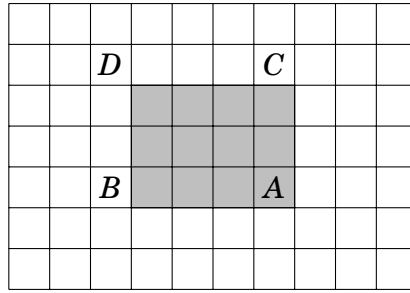

The sum of the gray subarray can be calculated using the formula

$$S(A) - S(B) - S(C) + S(D),$$

where  $S(X)$  denotes the sum of values in a rectangular subarray from the upper-left corner to the position of  $X$ .

### Minimum queries

Minimum queries are more difficult to process than sum queries. Still, there is a quite simple  $O(n \log n)$  time preprocessing method after which we can answer any minimum query in  $O(1)$  time<sup>1</sup>. Note that since minimum and maximum queries can be processed similarly, we can focus on minimum queries.

The idea is to precalculate all values of  $\min_q(a, b)$  where  $b - a + 1$  (the length of the range) is a power of two. For example, for the array

|   |   |   |   |   |   |   |   |
|---|---|---|---|---|---|---|---|
| 0 | 1 | 2 | 3 | 4 | 5 | 6 | 7 |
| 1 | 3 | 4 | 8 | 6 | 1 | 4 | 2 |

the following values are calculated:

| $a$ | $b$ | $\min_q(a, b)$ | $a$ | $b$ | $\min_q(a, b)$ | $a$ | $b$ | $\min_q(a, b)$ |
|-----|-----|----------------|-----|-----|----------------|-----|-----|----------------|
| 0   | 0   | 1              | 0   | 1   | 1              | 0   | 3   | 1              |
| 1   | 1   | 3              | 1   | 2   | 3              | 1   | 4   | 3              |
| 2   | 2   | 4              | 2   | 3   | 4              | 2   | 5   | 1              |
| 3   | 3   | 8              | 3   | 4   | 6              | 3   | 6   | 1              |
| 4   | 4   | 6              | 4   | 5   | 1              | 4   | 7   | 1              |
| 5   | 5   | 1              | 5   | 6   | 1              | 0   | 7   | 1              |
| 6   | 6   | 4              | 6   | 7   | 2              |     |     |                |
| 7   | 7   | 2              |     |     |                |     |     |                |

The number of precalculated values is  $O(n \log n)$ , because there are  $O(\log n)$  range lengths that are powers of two. The values can be calculated efficiently using the recursive formula

$$\min_q(a, b) = \min(\min_q(a, a + w - 1), \min_q(a + w, b)),$$

<sup>1</sup>This technique was introduced in [7] and sometimes called the **sparse table** method. There are also more sophisticated techniques [22] where the preprocessing time is only  $O(n)$ , but such algorithms are not needed in competitive programming.

where  $b - a + 1$  is a power of two and  $w = (b - a + 1)/2$ . Calculating all those values takes  $O(n \log n)$  time.

After this, any value of  $\min_q(a, b)$  can be calculated in  $O(1)$  time as a minimum of two precalculated values. Let  $k$  be the largest power of two that does not exceed  $b - a + 1$ . We can calculate the value of  $\min_q(a, b)$  using the formula

$$\min_q(a, b) = \min(\min_q(a, a + k - 1), \min_q(b - k + 1, b)).$$

In the above formula, the range  $[a, b]$  is represented as the union of the ranges  $[a, a + k - 1]$  and  $[b - k + 1, b]$ , both of length  $k$ .

As an example, consider the range  $[1, 6]$ :

|   |   |   |   |   |   |   |   |
|---|---|---|---|---|---|---|---|
| 0 | 1 | 2 | 3 | 4 | 5 | 6 | 7 |
| 1 | 3 | 4 | 8 | 6 | 1 | 4 | 2 |

The length of the range is 6, and the largest power of two that does not exceed 6 is 4. Thus the range  $[1, 6]$  is the union of the ranges  $[1, 4]$  and  $[3, 6]$ :

|   |   |   |   |   |   |   |   |
|---|---|---|---|---|---|---|---|
| 0 | 1 | 2 | 3 | 4 | 5 | 6 | 7 |
| 1 | 3 | 4 | 8 | 6 | 1 | 4 | 2 |

|   |   |   |   |   |   |   |   |
|---|---|---|---|---|---|---|---|
| 0 | 1 | 2 | 3 | 4 | 5 | 6 | 7 |
| 1 | 3 | 4 | 8 | 6 | 1 | 4 | 2 |

Since  $\min_q(1, 4) = 3$  and  $\min_q(3, 6) = 1$ , we conclude that  $\min_q(1, 6) = 1$ .

## 9.2 Binary indexed tree

A **binary indexed tree** or a **Fenwick tree**<sup>2</sup> can be seen as a dynamic variant of a prefix sum array. It supports two  $O(\log n)$  time operations on an array: processing a range sum query and updating a value.

The advantage of a binary indexed tree is that it allows us to efficiently update array values between sum queries. This would not be possible using a prefix sum array, because after each update, it would be necessary to build the whole prefix sum array again in  $O(n)$  time.

### Structure

Even if the name of the structure is a binary indexed *tree*, it is usually represented as an array. In this section we assume that all arrays are one-indexed, because it makes the implementation easier.

Let  $p(k)$  denote the largest power of two that divides  $k$ . We store a binary indexed tree as an array *tree* such that

$$\text{tree}[k] = \text{sum}_q(k - p(k) + 1, k),$$

<sup>2</sup>The binary indexed tree structure was presented by P. M. Fenwick in 1994 [21].



i.e., each position  $k$  contains the sum of values in a range of the original array whose length is  $p(k)$  and that ends at position  $k$ . For example, since  $p(6) = 2$ ,  $tree[6]$  contains the value of  $sum_q(5,6)$ .

For example, consider the following array:

| 1 | 2 | 3 | 4 | 5 | 6 | 7 | 8 |
|---|---|---|---|---|---|---|---|
| 1 | 3 | 4 | 8 | 6 | 1 | 4 | 2 |

The corresponding binary indexed tree is as follows:

| 1 | 2 | 3 | 4  | 5 | 6 | 7 | 8  |
|---|---|---|----|---|---|---|----|
| 1 | 4 | 4 | 16 | 6 | 7 | 4 | 29 |

The following picture shows more clearly how each value in the binary indexed tree corresponds to a range in the original array:

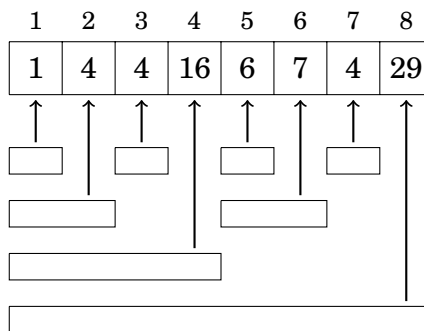

Using a binary indexed tree, any value of  $sum_q(1, k)$  can be calculated in  $O(\log n)$  time, because a range  $[1, k]$  can always be divided into  $O(\log n)$  ranges whose sums are stored in the tree.

For example, the range  $[1, 7]$  consists of the following ranges:

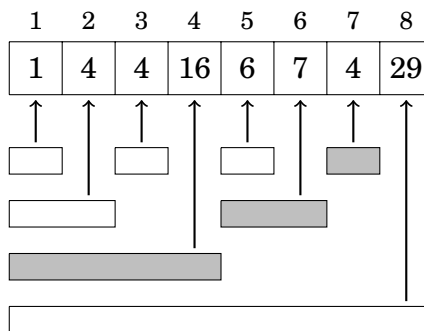

Thus, we can calculate the corresponding sum as follows:

$$sum_q(1, 7) = sum_q(1, 4) + sum_q(5, 6) + sum_q(7, 7) = 16 + 7 + 4 = 27$$

To calculate the value of  $sum_q(a, b)$  where  $a > 1$ , we can use the same trick that we used with prefix sum arrays:

$$sum_q(a, b) = sum_q(1, b) - sum_q(1, a - 1).$$

Since we can calculate both  $\text{sum}_q(1, b)$  and  $\text{sum}_q(1, a - 1)$  in  $O(\log n)$  time, the total time complexity is  $O(\log n)$ .

Then, after updating a value in the original array, several values in the binary indexed tree should be updated. For example, if the value at position 3 changes, the sums of the following ranges change:

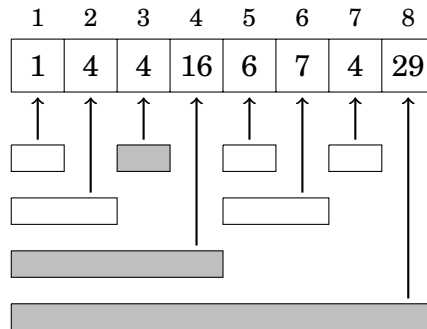

Since each array element belongs to  $O(\log n)$  ranges in the binary indexed tree, it suffices to update  $O(\log n)$  values in the tree.

## Implementation

The operations of a binary indexed tree can be efficiently implemented using bit operations. The key fact needed is that we can calculate any value of  $p(k)$  using the formula

$$p(k) = k \& -k.$$

The following function calculates the value of  $\text{sum}_q(1, k)$ :

```
int sum(int k) {
    int s = 0;
    while (k >= 1) {
        s += tree[k];
        k -= k & -k;
    }
    return s;
}
```

The following function increases the array value at position  $k$  by  $x$  ( $x$  can be positive or negative):

```
void add(int k, int x) {
    while (k <= n) {
        tree[k] += x;
        k += k & -k;
    }
}
```

The time complexity of both the functions is  $O(\log n)$ , because the functions access  $O(\log n)$  values in the binary indexed tree, and each move to the next position takes  $O(1)$  time.

## 9.3 Segment tree

A **segment tree**<sup>3</sup> is a data structure that supports two operations: processing a range query and updating an array value. Segment trees can support sum queries, minimum and maximum queries and many other queries so that both operations work in  $O(\log n)$  time.

Compared to a binary indexed tree, the advantage of a segment tree is that it is a more general data structure. While binary indexed trees only support sum queries<sup>4</sup>, segment trees also support other queries. On the other hand, a segment tree requires more memory and is a bit more difficult to implement.

### Structure

A segment tree is a binary tree such that the nodes on the bottom level of the tree correspond to the array elements, and the other nodes contain information needed for processing range queries.

In this section, we assume that the size of the array is a power of two and zero-based indexing is used, because it is convenient to build a segment tree for such an array. If the size of the array is not a power of two, we can always append extra elements to it.

We will first discuss segment trees that support sum queries. As an example, consider the following array:

|   |   |   |   |   |   |   |   |
|---|---|---|---|---|---|---|---|
| 0 | 1 | 2 | 3 | 4 | 5 | 6 | 7 |
| 5 | 8 | 6 | 3 | 2 | 7 | 2 | 6 |

The corresponding segment tree is as follows:

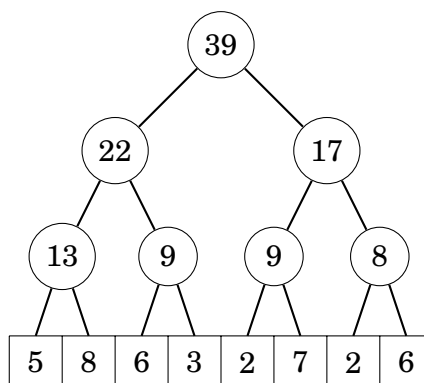

Each internal tree node corresponds to an array range whose size is a power of two. In the above tree, the value of each internal node is the sum of the corresponding array values, and it can be calculated as the sum of the values of its left and right child node.

<sup>3</sup>The bottom-up-implementation in this chapter corresponds to that in [62]. Similar structures were used in late 1970's to solve geometric problems [9].

<sup>4</sup>In fact, using *two* binary indexed trees it is possible to support minimum queries [16], but this is more complicated than to use a segment tree.

It turns out that any range  $[a, b]$  can be divided into  $O(\log n)$  ranges whose values are stored in tree nodes. For example, consider the range  $[2, 7]$ :

|   |   |   |   |   |   |   |   |
|---|---|---|---|---|---|---|---|
| 0 | 1 | 2 | 3 | 4 | 5 | 6 | 7 |
| 5 | 8 | 6 | 3 | 2 | 7 | 2 | 6 |

Here  $\text{sum}_q(2, 7) = 6 + 3 + 2 + 7 + 2 + 6 = 26$ . In this case, the following two tree nodes correspond to the range:

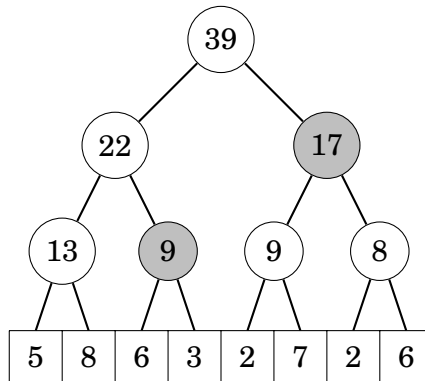

Thus, another way to calculate the sum is  $9 + 17 = 26$ .

When the sum is calculated using nodes located as high as possible in the tree, at most two nodes on each level of the tree are needed. Hence, the total number of nodes is  $O(\log n)$ .

After an array update, we should update all nodes whose value depends on the updated value. This can be done by traversing the path from the updated array element to the top node and updating the nodes along the path.

The following picture shows which tree nodes change if the array value 7 changes:

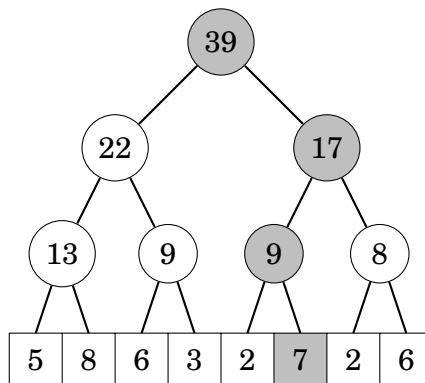

The path from bottom to top always consists of  $O(\log n)$  nodes, so each update changes  $O(\log n)$  nodes in the tree.

## Implementation

We store a segment tree as an array of  $2n$  elements where  $n$  is the size of the original array and a power of two. The tree nodes are stored from top to bottom:

tree[1] is the top node, tree[2] and tree[3] are its children, and so on. Finally, the values from tree[n] to tree[2n - 1] correspond to the values of the original array on the bottom level of the tree.

For example, the segment tree

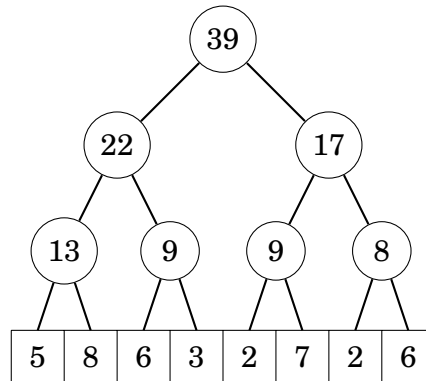

is stored as follows:

|    |    |    |    |   |   |   |   |   |    |    |    |    |    |    |
|----|----|----|----|---|---|---|---|---|----|----|----|----|----|----|
| 1  | 2  | 3  | 4  | 5 | 6 | 7 | 8 | 9 | 10 | 11 | 12 | 13 | 14 | 15 |
| 39 | 22 | 17 | 13 | 9 | 9 | 8 | 5 | 8 | 6  | 3  | 2  | 7  | 2  | 6  |

Using this representation, the parent of tree[k] is tree[ $\lfloor k/2 \rfloor$ ], and its children are tree[2k] and tree[2k + 1]. Note that this implies that the position of a node is even if it is a left child and odd if it is a right child.

The following function calculates the value of  $\text{sum}_q(a, b)$ :

```

int sum(int a, int b) {
    a += n; b += n;
    int s = 0;
    while (a <= b) {
        if (a%2 == 1) s += tree[a++];
        if (b%2 == 0) s += tree[b--];
        a /= 2; b /= 2;
    }
    return s;
}

```

The function maintains a range that is initially  $[a + n, b + n]$ . Then, at each step, the range is moved one level higher in the tree, and before that, the values of the nodes that do not belong to the higher range are added to the sum.

The following function increases the array value at position  $k$  by  $x$ :

```

void add(int k, int x) {
    k += n;
    tree[k] += x;
    for (k /= 2; k >= 1; k /= 2) {
        tree[k] = tree[2*k] + tree[2*k+1];
    }
}

```

First the function updates the value at the bottom level of the tree. After this, the function updates the values of all internal tree nodes, until it reaches the top node of the tree.

Both the above functions work in  $O(\log n)$  time, because a segment tree of  $n$  elements consists of  $O(\log n)$  levels, and the functions move one level higher in the tree at each step.

## Other queries

Segment trees can support all range queries where it is possible to divide a range into two parts, calculate the answer separately for both parts and then efficiently combine the answers. Examples of such queries are minimum and maximum, greatest common divisor, and bit operations and, or and xor.

For example, the following segment tree supports minimum queries:

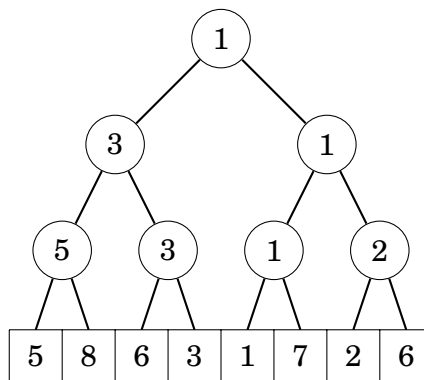

In this case, every tree node contains the smallest value in the corresponding array range. The top node of the tree contains the smallest value in the whole array. The operations can be implemented like previously, but instead of sums, minima are calculated.

The structure of a segment tree also allows us to use binary search for locating array elements. For example, if the tree supports minimum queries, we can find the position of an element with the smallest value in  $O(\log n)$  time.

For example, in the above tree, an element with the smallest value 1 can be found by traversing a path downwards from the top node:

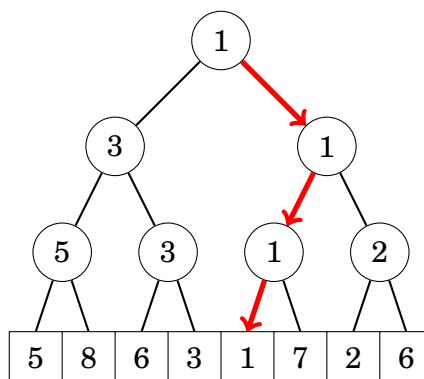

## 9.4 Additional techniques

### Index compression

A limitation in data structures that are built upon an array is that the elements are indexed using consecutive integers. Difficulties arise when large indices are needed. For example, if we wish to use the index  $10^9$ , the array should contain  $10^9$  elements which would require too much memory.

However, we can often bypass this limitation by using **index compression**, where the original indices are replaced with indices 1, 2, 3, etc. This can be done if we know all the indices needed during the algorithm beforehand.

The idea is to replace each original index  $x$  with  $c(x)$  where  $c$  is a function that compresses the indices. We require that the order of the indices does not change, so if  $a < b$ , then  $c(a) < c(b)$ . This allows us to conveniently perform queries even if the indices are compressed.

For example, if the original indices are 555,  $10^9$  and 8, the new indices are:

$$\begin{aligned}c(8) &= 1 \\c(555) &= 2 \\c(10^9) &= 3\end{aligned}$$

### Range updates

So far, we have implemented data structures that support range queries and updates of single values. Let us now consider an opposite situation, where we should update ranges and retrieve single values. We focus on an operation that increases all elements in a range  $[a, b]$  by  $x$ .

Surprisingly, we can use the data structures presented in this chapter also in this situation. To do this, we build a **difference array** whose values indicate the differences between consecutive values in the original array. Thus, the original array is the prefix sum array of the difference array. For example, consider the following array:

| 0 | 1 | 2 | 3 | 4 | 5 | 6 | 7 |
|---|---|---|---|---|---|---|---|
| 3 | 3 | 1 | 1 | 1 | 5 | 2 | 2 |

The difference array for the above array is as follows:

| 0 | 1 | 2  | 3 | 4 | 5 | 6  | 7 |
|---|---|----|---|---|---|----|---|
| 3 | 0 | -2 | 0 | 0 | 4 | -3 | 0 |

For example, the value 2 at position 6 in the original array corresponds to the sum  $3 - 2 + 4 - 3 = 2$  in the difference array.

The advantage of the difference array is that we can update a range in the original array by changing just two elements in the difference array. For example, if we want to increase the original array values between positions 1 and 4 by 5, it suffices to increase the difference array value at position 1 by 5 and decrease the value at position 5 by 5. The result is as follows:

|   |   |    |   |   |    |    |   |
|---|---|----|---|---|----|----|---|
| 0 | 1 | 2  | 3 | 4 | 5  | 6  | 7 |
| 3 | 5 | -2 | 0 | 0 | -1 | -3 | 0 |

More generally, to increase the values in range  $[a, b]$  by  $x$ , we increase the value at position  $a$  by  $x$  and decrease the value at position  $b + 1$  by  $x$ . Thus, it is only needed to update single values and process sum queries, so we can use a binary indexed tree or a segment tree.

A more difficult problem is to support both range queries and range updates. In Chapter 28 we will see that even this is possible.



# Chapter 10

## Bit manipulation

All data in computer programs is internally stored as bits, i.e., as numbers 0 and 1. This chapter discusses the bit representation of integers, and shows examples of how to use bit operations. It turns out that there are many uses for bit manipulation in algorithm programming.

### 10.1 Bit representation

In programming, an  $n$  bit integer is internally stored as a binary number that consists of  $n$  bits. For example, the C++ type `int` is a 32-bit type, which means that every `int` number consists of 32 bits.

Here is the bit representation of the `int` number 43:

0000000000000000000000000101011

The bits in the representation are indexed from right to left. To convert a bit representation  $b_k \cdots b_2 b_1 b_0$  into a number, we can use the formula

$$b_k 2^k + \dots + b_2 2^2 + b_1 2^1 + b_0 2^0.$$

For example,

$$1 \cdot 2^5 + 1 \cdot 2^3 + 1 \cdot 2^1 + 1 \cdot 2^0 = 43.$$

The bit representation of a number is either **signed** or **unsigned**. Usually a signed representation is used, which means that both negative and positive numbers can be represented. A signed variable of  $n$  bits can contain any integer between  $-2^{n-1}$  and  $2^{n-1} - 1$ . For example, the `int` type in C++ is a signed type, so an `int` variable can contain any integer between  $-2^{31}$  and  $2^{31} - 1$ .

The first bit in a signed representation is the sign of the number (0 for nonnegative numbers and 1 for negative numbers), and the remaining  $n - 1$  bits contain the magnitude of the number. **Two's complement** is used, which means that the opposite number of a number is calculated by first inverting all the bits in the number, and then increasing the number by one.

For example, the bit representation of the `int` number `-43` is

111111111111111111111111010101.

In an unsigned representation, only nonnegative numbers can be used, but the upper bound for the values is larger. An unsigned variable of  $n$  bits can contain any integer between 0 and  $2^n - 1$ . For example, in C++, an unsigned `int` variable can contain any integer between 0 and  $2^{32} - 1$ .

There is a connection between the representations: a signed number  $-x$  equals an unsigned number  $2^n - x$ . For example, the following code shows that the signed number  $x = -43$  equals the unsigned number  $y = 2^{32} - 43$ :

```
int x = -43;
unsigned int y = x;
cout << x << "\n"; // -43
cout << y << "\n"; // 4294967253
```

If a number is larger than the upper bound of the bit representation, the number will overflow. In a signed representation, the next number after  $2^{n-1} - 1$  is  $-2^{n-1}$ , and in an unsigned representation, the next number after  $2^{n-1}$  is 0. For example, consider the following code:

```
int x = 2147483647
cout << x << "\n"; // 2147483647
x++;
cout << x << "\n"; // -2147483648
```

Initially, the value of  $x$  is  $2^{31} - 1$ . This is the largest value that can be stored in an `int` variable, so the next number after  $2^{31} - 1$  is  $-2^{31}$ .

## 10.2 Bit operations

### And operation

The **and** operation  $x \& y$  produces a number that has one bits in positions where both  $x$  and  $y$  have one bits. For example,  $22 \& 26 = 18$ , because

$$\begin{array}{r} 10110 \quad (22) \\ \& \quad 11010 \quad (26) \\ \hline = \quad 10010 \quad (18) \end{array}$$

Using the and operation, we can check if a number  $x$  is even because  $x \& 1 = 0$  if  $x$  is even, and  $x \& 1 = 1$  if  $x$  is odd. More generally,  $x$  is divisible by  $2^k$  exactly when  $x \& (2^k - 1) = 0$ .

### Or operation

The **or** operation  $x \mid y$  produces a number that has one bits in positions where at least one of  $x$  and  $y$  have one bits. For example,  $22 \mid 26 = 30$ , because

$$\begin{array}{r} 10110 \quad (22) \\ \mid \quad 11010 \quad (26) \\ \hline = \quad 11110 \quad (30) \end{array}$$

## Xor operation

The **xor** operation  $x \wedge y$  produces a number that has one bits in positions where exactly one of  $x$  and  $y$  have one bits. For example,  $22 \wedge 26 = 12$ , because

$$\begin{array}{r} 10110 \quad (22) \\ \wedge \quad 11010 \quad (26) \\ \hline = \quad 01100 \quad (12) \end{array}$$

## Not operation

The **not** operation  $\sim x$  produces a number where all the bits of  $x$  have been inverted. The formula  $\sim x = -x - 1$  holds, for example,  $\sim 29 = -30$ .

The result of the not operation at the bit level depends on the length of the bit representation, because the operation inverts all bits. For example, if the numbers are 32-bit int numbers, the result is as follows:

$$\begin{array}{r} x = 29 \quad 000000000000000000000000011101 \\ \sim x = -30 \quad 111111111111111111111111110010 \end{array}$$

## Bit shifts

The left bit shift  $x \ll k$  appends  $k$  zero bits to the number, and the right bit shift  $x \gg k$  removes the  $k$  last bits from the number. For example,  $14 \ll 2 = 56$ , because 14 and 56 correspond to 1110 and 111000. Similarly,  $49 \gg 3 = 6$ , because 49 and 6 correspond to 110001 and 110.

Note that  $x \ll k$  corresponds to multiplying  $x$  by  $2^k$ , and  $x \gg k$  corresponds to dividing  $x$  by  $2^k$  rounded down to an integer.

## Applications

A number of the form  $1 \ll k$  has a one bit in position  $k$  and all other bits are zero, so we can use such numbers to access single bits of numbers. In particular, the  $k$ th bit of a number is one exactly when  $x \& (1 \ll k)$  is not zero. The following code prints the bit representation of an int number  $x$ :

```
for (int i = 31; i >= 0; i--) {
    if (x & (1 << i)) cout << "1";
    else cout << "0";
}
```

It is also possible to modify single bits of numbers using similar ideas. For example, the formula  $x \mid (1 \ll k)$  sets the  $k$ th bit of  $x$  to one, the formula  $x \& \sim(1 \ll k)$  sets the  $k$ th bit of  $x$  to zero, and the formula  $x \wedge (1 \ll k)$  inverts the  $k$ th bit of  $x$ .

The formula  $x \& (x - 1)$  sets the last one bit of  $x$  to zero, and the formula  $x \& -x$  sets all the one bits to zero, except for the last one bit. The formula  $x \mid (x - 1)$  inverts all the bits after the last one bit. Also note that a positive number  $x$  is a power of two exactly when  $x \& (x - 1) = 0$ .

## Additional functions

The g++ compiler provides the following functions for counting bits:

- `__builtin_clz(x)`: the number of zeros at the beginning of the number
- `__builtin_ctz(x)`: the number of zeros at the end of the number
- `__builtin_popcount(x)`: the number of ones in the number
- `__builtin_parity(x)`: the parity (even or odd) of the number of ones

The functions can be used as follows:

```
int x = 5328; // 00000000000000000001010011010000
cout << __builtin_clz(x) << "\n"; // 19
cout << __builtin_ctz(x) << "\n"; // 4
cout << __builtin_popcount(x) << "\n"; // 5
cout << __builtin_parity(x) << "\n"; // 1
```

While the above functions only support `int` numbers, there are also long long versions of the functions available with the suffix `ll`.

## 10.3 Representing sets

Every subset of a set  $\{0, 1, 2, \dots, n-1\}$  can be represented as an  $n$  bit integer whose one bits indicate which elements belong to the subset. This is an efficient way to represent sets, because every element requires only one bit of memory, and set operations can be implemented as bit operations.

For example, since `int` is a 32-bit type, an `int` number can represent any subset of the set  $\{0, 1, 2, \dots, 31\}$ . The bit representation of the set  $\{1, 3, 4, 8\}$  is

000000000000000000000000100011010,

which corresponds to the number  $2^8 + 2^4 + 2^3 + 2^1 = 282$ .

### Set implementation

The following code declares an `int` variable `x` that can contain a subset of  $\{0, 1, 2, \dots, 31\}$ . After this, the code adds the elements 1, 3, 4 and 8 to the set and prints the size of the set.

```
int x = 0;
x |= (1<<1);
x |= (1<<3);
x |= (1<<4);
x |= (1<<8);
cout << __builtin_popcount(x) << "\n"; // 4
```

Then, the following code prints all elements that belong to the set:

```
for (int i = 0; i < 32; i++) {
    if (x&(1<<i)) cout << i << " ";
}
// output: 1 3 4 8
```

## Set operations

Set operations can be implemented as follows as bit operations:

|              | set syntax      | bit syntax      |
|--------------|-----------------|-----------------|
| intersection | $a \cap b$      | $a \& b$        |
| union        | $a \cup b$      | $a   b$         |
| complement   | $\bar{a}$       | $\sim a$        |
| difference   | $a \setminus b$ | $a \& (\sim b)$ |

For example, the following code first constructs the sets  $x = \{1, 3, 4, 8\}$  and  $y = \{3, 6, 8, 9\}$ , and then constructs the set  $z = x \cup y = \{1, 3, 4, 6, 8, 9\}$ :

```
int x = (1<<1)+(1<<3)+(1<<4)+(1<<8);
int y = (1<<3)+(1<<6)+(1<<8)+(1<<9);
int z = x|y;
cout << __builtin_popcount(z) << "\n"; // 6
```

## Iterating through subsets

The following code goes through the subsets of  $\{0, 1, \dots, n-1\}$ :

```
for (int b = 0; b < (1<<n); b++) {
    // process subset b
}
```

The following code goes through the subsets with exactly  $k$  elements:

```
for (int b = 0; b < (1<<n); b++) {
    if (__builtin_popcount(b) == k) {
        // process subset b
    }
}
```

The following code goes through the subsets of a set  $x$ :

```
int b = 0;
do {
    // process subset b
} while (b=(b-x)&x);
```

## 10.4 Bit optimizations

Many algorithms can be optimized using bit operations. Such optimizations do not change the time complexity of the algorithm, but they may have a large impact on the actual running time of the code. In this section we discuss examples of such situations.

### Hamming distances

The **Hamming distance**  $\text{hamming}(a,b)$  between two strings  $a$  and  $b$  of equal length is the number of positions where the strings differ. For example,

$$\text{hamming}(01101,11001) = 2.$$

Consider the following problem: Given a list of  $n$  bit strings, each of length  $k$ , calculate the minimum Hamming distance between two strings in the list. For example, the answer for  $[00111,01101,11110]$  is 2, because

- $\text{hamming}(00111,01101) = 2$ ,
- $\text{hamming}(00111,11110) = 3$ , and
- $\text{hamming}(01101,11110) = 3$ .

A straightforward way to solve the problem is to go through all pairs of strings and calculate their Hamming distances, which yields an  $O(n^2k)$  time algorithm. The following function can be used to calculate distances:

```
int hamming(string a, string b) {
    int d = 0;
    for (int i = 0; i < k; i++) {
        if (a[i] != b[i]) d++;
    }
    return d;
}
```

However, if  $k$  is small, we can optimize the code by storing the bit strings as integers and calculating the Hamming distances using bit operations. In particular, if  $k \leq 32$ , we can just store the strings as `int` values and use the following function to calculate distances:

```
int hamming(int a, int b) {
    return __builtin_popcount(a^b);
}
```

In the above function, the xor operation constructs a bit string that has one bits in positions where  $a$  and  $b$  differ. Then, the number of bits is calculated using the `__builtin_popcount` function.

To compare the implementations, we generated a list of 10000 random bit strings of length 30. Using the first approach, the search took 13.5 seconds, and after the bit optimization, it only took 0.5 seconds. Thus, the bit optimized code was almost 30 times faster than the original code.

## Counting subgrids

As another example, consider the following problem: Given an  $n \times n$  grid whose each square is either black (1) or white (0), calculate the number of subgrids whose all corners are black. For example, the grid

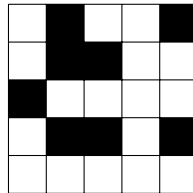

contains two such subgrids:

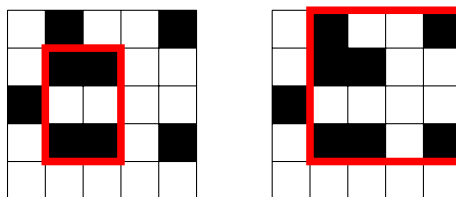

There is an  $O(n^3)$  time algorithm for solving the problem: go through all  $O(n^2)$  pairs of rows and for each pair  $(a, b)$  calculate the number of columns that contain a black square in both rows in  $O(n)$  time. The following code assumes that  $\text{color}[y][x]$  denotes the color in row  $y$  and column  $x$ :

```
int count = 0;
for (int i = 0; i < n; i++) {
    if (color[a][i] == 1 && color[b][i] == 1) count++;
}
```

Then, those columns account for  $\text{count}(\text{count} - 1)/2$  subgrids with black corners, because we can choose any two of them to form a subgrid.

To optimize this algorithm, we divide the grid into blocks of columns such that each block consists of  $N$  consecutive columns. Then, each row is stored as a list of  $N$ -bit numbers that describe the colors of the squares. Now we can process  $N$  columns at the same time using bit operations. In the following code,  $\text{color}[y][k]$  represents a block of  $N$  colors as bits.

```
int count = 0;
for (int i = 0; i <= n/N; i++) {
    count += __builtin_popcount(color[a][i]&color[b][i]);
}
```

The resulting algorithm works in  $O(n^3/N)$  time.

We generated a random grid of size  $2500 \times 2500$  and compared the original and bit optimized implementation. While the original code took 29.6 seconds, the bit optimized version only took 3.1 seconds with  $N = 32$  (int numbers) and 1.7 seconds with  $N = 64$  (long long numbers).

## 10.5 Dynamic programming

Bit operations provide an efficient and convenient way to implement dynamic programming algorithms whose states contain subsets of elements, because such states can be stored as integers. Next we discuss examples of combining bit operations and dynamic programming.

### Optimal selection

As a first example, consider the following problem: We are given the prices of  $k$  products over  $n$  days, and we want to buy each product exactly once. However, we are allowed to buy at most one product in a day. What is the minimum total price? For example, consider the following scenario ( $k = 3$  and  $n = 8$ ):

|           | 0 | 1 | 2 | 3 | 4 | 5 | 6 | 7 |
|-----------|---|---|---|---|---|---|---|---|
| product 0 | 6 | 9 | 5 | 2 | 8 | 9 | 1 | 6 |
| product 1 | 8 | 2 | 6 | 2 | 7 | 5 | 7 | 2 |
| product 2 | 5 | 3 | 9 | 7 | 3 | 5 | 1 | 4 |

In this scenario, the minimum total price is 5:

|           | 0 | 1 | 2 | 3 | 4 | 5 | 6 | 7 |
|-----------|---|---|---|---|---|---|---|---|
| product 0 | 6 | 9 | 5 | 2 | 8 | 9 | 1 | 6 |
| product 1 | 8 | 2 | 6 | 2 | 7 | 5 | 7 | 2 |
| product 2 | 5 | 3 | 9 | 7 | 3 | 5 | 1 | 4 |

Let  $\text{price}[x][d]$  denote the price of product  $x$  on day  $d$ . For example, in the above scenario  $\text{price}[2][3] = 7$ . Then, let  $\text{total}(S, d)$  denote the minimum total price for buying a subset  $S$  of products by day  $d$ . Using this function, the solution to the problem is  $\text{total}(\{0 \dots k - 1\}, n - 1)$ .

First,  $\text{total}(\emptyset, d) = 0$ , because it does not cost anything to buy an empty set, and  $\text{total}(\{x\}, 0) = \text{price}[x][0]$ , because there is one way to buy one product on the first day. Then, the following recurrence can be used:

$$\text{total}(S, d) = \min(\text{total}(S, d - 1), \min_{x \in S} (\text{total}(S \setminus x, d - 1) + \text{price}[x][d]))$$

This means that we either do not buy any product on day  $d$  or buy a product  $x$  that belongs to  $S$ . In the latter case, we remove  $x$  from  $S$  and add the price of  $x$  to the total price.

The next step is to calculate the values of the function using dynamic programming. To store the function values, we declare an array

```
int total[1<<K][N];
```



where  $K$  and  $N$  are suitably large constants. The first dimension of the array corresponds to a bit representation of a subset.

First, the cases where  $d = 0$  can be processed as follows:

```
for (int x = 0; x < k; x++) {
    total[1<<x][0] = price[x][0];
}
```

Then, the recurrence translates into the following code:

```
for (int d = 1; d < n; d++) {
    for (int s = 0; s < (1<<k); s++) {
        total[s][d] = total[s][d-1];
        for (int x = 0; x < k; x++) {
            if (s&(1<<x)) {
                total[s][d] = min(total[s][d],
                                   total[s^(1<<x)][d-1]+price[x][d]);
            }
        }
    }
}
```

The time complexity of the algorithm is  $O(n2^k k)$ .

## From permutations to subsets

Using dynamic programming, it is often possible to change an iteration over permutations into an iteration over subsets<sup>1</sup>. The benefit of this is that  $n!$ , the number of permutations, is much larger than  $2^n$ , the number of subsets. For example, if  $n = 20$ , then  $n! \approx 2.4 \cdot 10^{18}$  and  $2^n \approx 10^6$ . Thus, for certain values of  $n$ , we can efficiently go through the subsets but not through the permutations.

As an example, consider the following problem: There is an elevator with maximum weight  $x$ , and  $n$  people with known weights who want to get from the ground floor to the top floor. What is the minimum number of rides needed if the people enter the elevator in an optimal order?

For example, suppose that  $x = 10$ ,  $n = 5$  and the weights are as follows:

| person | weight |
|--------|--------|
| 0      | 2      |
| 1      | 3      |
| 2      | 3      |
| 3      | 5      |
| 4      | 6      |

In this case, the minimum number of rides is 2. One optimal order is  $\{0, 2, 3, 1, 4\}$ , which partitions the people into two rides: first  $\{0, 2, 3\}$  (total weight 10), and then  $\{1, 4\}$  (total weight 9).

<sup>1</sup>This technique was introduced in 1962 by M. Held and R. M. Karp [34].

The problem can be easily solved in  $O(n!n)$  time by testing all possible permutations of  $n$  people. However, we can use dynamic programming to get a more efficient  $O(2^n n)$  time algorithm. The idea is to calculate for each subset of people two values: the minimum number of rides needed and the minimum weight of people who ride in the last group.

Let  $\text{weight}[p]$  denote the weight of person  $p$ . We define two functions:  $\text{rides}(S)$  is the minimum number of rides for a subset  $S$ , and  $\text{last}(S)$  is the minimum weight of the last ride. For example, in the above scenario

$$\text{rides}(\{1,3,4\}) = 2 \quad \text{and} \quad \text{last}(\{1,3,4\}) = 5,$$

because the optimal rides are  $\{1, 4\}$  and  $\{3\}$ , and the second ride has weight 5. Of course, our final goal is to calculate the value of  $\text{rides}(\{0 \dots n - 1\})$ .

We can calculate the values of the functions recursively and then apply dynamic programming. The idea is to go through all people who belong to  $S$  and optimally choose the last person  $p$  who enters the elevator. Each such choice yields a subproblem for a smaller subset of people. If  $\text{last}(S \setminus p) + \text{weight}[p] \leq x$ , we can add  $p$  to the last ride. Otherwise, we have to reserve a new ride that initially only contains  $p$ .

To implement dynamic programming, we declare an array

```
pair<int,int> best[1<<N];
```

that contains for each subset  $S$  a pair  $(\text{rides}(S), \text{last}(S))$ . For an empty group, no rides are needed:

```
best[0] = {0,0};
```

Then, we can fill the array as follows:

```
for (int s = 1; s < (1<<n); s++) {
    // initial value: n rides are needed
    best[s] = {n,0};
    for (int p = 0; p < n; p++) {
        if (s&(1<<p)) {
            auto option = best[s^(1<<p)];
            if (option.second+weight[p] <= x) {
                // add p to an existing ride
                option.second += weight[p];
            } else {
                // reserve a new ride for p
                option.first++;
                option.second = weight[p];
            }
            best[s] = min(best[s], option);
        }
    }
}
```

Note that the above loop guarantees that for any two subsets  $S_1$  and  $S_2$  such that  $S_1 \subset S_2$ , we process  $S_1$  before  $S_2$ . Thus, the dynamic programming values are calculated in the correct order.

## Counting subsets

Our last problem in this chapter is as follows: Let  $X = \{0 \dots n - 1\}$ , and each subset  $S \subset X$  is assigned an integer  $\text{value}[S]$ . Our task is to calculate for each  $S$

$$\text{sum}(S) = \sum_{A \subset S} \text{value}[A],$$

i.e., the sum of values of subsets of  $S$ .

For example, suppose that  $n = 3$  and the values are as follows:

- $\text{value}[\emptyset] = 3$
- $\text{value}[\{0\}] = 1$
- $\text{value}[\{1\}] = 4$
- $\text{value}[\{0, 1\}] = 5$
- $\text{value}[\{2\}] = 5$
- $\text{value}[\{0, 2\}] = 1$
- $\text{value}[\{1, 2\}] = 3$
- $\text{value}[\{0, 1, 2\}] = 3$

In this case, for example,

$$\begin{aligned} \text{sum}(\{0, 2\}) &= \text{value}[\emptyset] + \text{value}[\{0\}] + \text{value}[\{2\}] + \text{value}[\{0, 2\}] \\ &= 3 + 1 + 5 + 1 = 10. \end{aligned}$$

Because there are a total of  $2^n$  subsets, one possible solution is to go through all pairs of subsets in  $O(2^{2n})$  time. However, using dynamic programming, we can solve the problem in  $O(2^n n)$  time. The idea is to focus on sums where the elements that may be removed from  $S$  are restricted.

Let  $\text{partial}(S, k)$  denote the sum of values of subsets of  $S$  with the restriction that only elements  $0 \dots k$  may be removed from  $S$ . For example,

$$\text{partial}(\{0, 2\}, 1) = \text{value}[\{2\}] + \text{value}[\{0, 2\}],$$

because we only may remove elements  $0 \dots 1$ . We can calculate values of  $\text{sum}$  using values of  $\text{partial}$ , because

$$\text{sum}(S) = \text{partial}(S, n - 1).$$

The base cases for the function are

$$\text{partial}(S, -1) = \text{value}[S],$$

because in this case no elements can be removed from  $S$ . Then, in the general case we can use the following recurrence:

$$\text{partial}(S, k) = \begin{cases} \text{partial}(S, k - 1) & k \notin S \\ \text{partial}(S, k - 1) + \text{partial}(S \setminus \{k\}, k - 1) & k \in S \end{cases}$$

Here we focus on the element  $k$ . If  $k \in S$ , we have two options: we may either keep  $k$  in  $S$  or remove it from  $S$ .

There is a particularly clever way to implement the calculation of sums. We can declare an array

```
int sum[1<<N];
```

that will contain the sum of each subset. The array is initialized as follows:

```
for (int s = 0; s < (1<<n); s++) {  
    sum[s] = value[s];  
}
```

Then, we can fill the array as follows:

```
for (int k = 0; k < n; k++) {  
    for (int s = 0; s < (1<<n); s++) {  
        if (s & (1<<k)) sum[s] += sum[s ^ (1<<k)];  
    }  
}
```

This code calculates the values of  $\text{partial}(S, k)$  for  $k = 0 \dots n - 1$  to the array `sum`. Since  $\text{partial}(S, k)$  is always based on  $\text{partial}(S, k - 1)$ , we can reuse the array `sum`, which yields a very efficient implementation.

**Part II**

**Graph algorithms**



# Chapter 11

## Basics of graphs

Many programming problems can be solved by modeling the problem as a graph problem and using an appropriate graph algorithm. A typical example of a graph is a network of roads and cities in a country. Sometimes, though, the graph is hidden in the problem and it may be difficult to detect it.

This part of the book discusses graph algorithms, especially focusing on topics that are important in competitive programming. In this chapter, we go through concepts related to graphs, and study different ways to represent graphs in algorithms.

### 11.1 Graph terminology

A **graph** consists of **nodes** and **edges**. In this book, the variable  $n$  denotes the number of nodes in a graph, and the variable  $m$  denotes the number of edges. The nodes are numbered using integers  $1, 2, \dots, n$ .

For example, the following graph consists of 5 nodes and 7 edges:

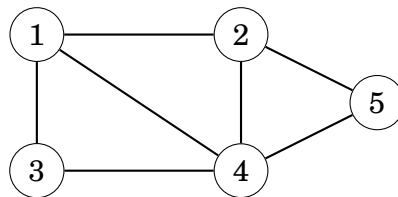

A **path** leads from node  $a$  to node  $b$  through edges of the graph. The **length** of a path is the number of edges in it. For example, the above graph contains a path  $1 \rightarrow 3 \rightarrow 4 \rightarrow 5$  of length 3 from node 1 to node 5:

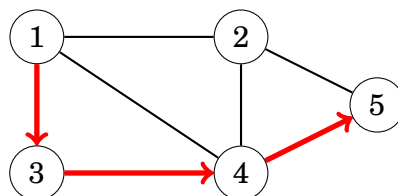

A path is a **cycle** if the first and last node is the same. For example, the above graph contains a cycle  $1 \rightarrow 3 \rightarrow 4 \rightarrow 1$ . A path is **simple** if each node appears at most once in the path.

## Connectivity

A graph is **connected** if there is a path between any two nodes. For example, the following graph is connected:

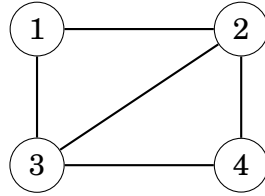

The following graph is not connected, because it is not possible to get from node 4 to any other node:

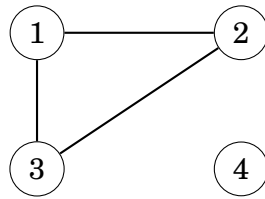

The connected parts of a graph are called its **components**. For example, the following graph contains three components: {1, 2, 3}, {4, 5, 6, 7} and {8}.

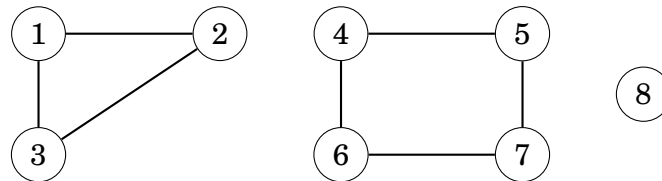

A **tree** is a connected graph that consists of  $n$  nodes and  $n - 1$  edges. There is a unique path between any two nodes of a tree. For example, the following graph is a tree:

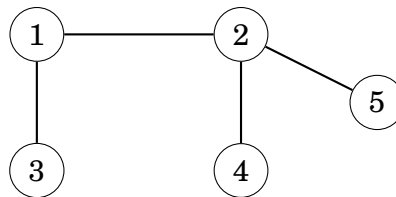

## Edge directions

A graph is **directed** if the edges can be traversed in one direction only. For example, the following graph is directed:

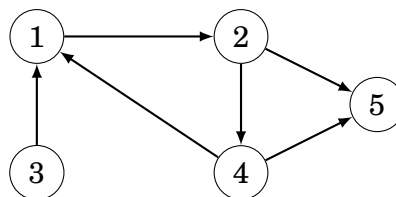

The above graph contains a path  $3 \rightarrow 1 \rightarrow 2 \rightarrow 5$  from node 3 to node 5, but there is no path from node 5 to node 3.



## Edge weights

In a **weighted** graph, each edge is assigned a **weight**. The weights are often interpreted as edge lengths. For example, the following graph is weighted:

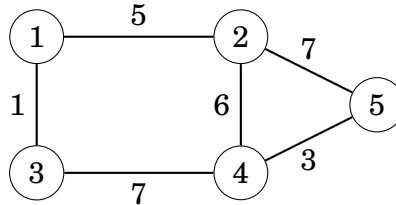

The length of a path in a weighted graph is the sum of the edge weights on the path. For example, in the above graph, the length of the path  $1 \rightarrow 2 \rightarrow 5$  is 12, and the length of the path  $1 \rightarrow 3 \rightarrow 4 \rightarrow 5$  is 11. The latter path is the **shortest** path from node 1 to node 5.

## Neighbors and degrees

Two nodes are **neighbors** or **adjacent** if there is an edge between them. The **degree** of a node is the number of its neighbors. For example, in the following graph, the neighbors of node 2 are 1, 4 and 5, so its degree is 3.

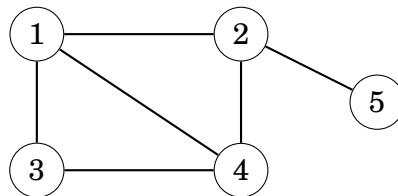

The sum of degrees in a graph is always  $2m$ , where  $m$  is the number of edges, because each edge increases the degree of exactly two nodes by one. For this reason, the sum of degrees is always even.

A graph is **regular** if the degree of every node is a constant  $d$ . A graph is **complete** if the degree of every node is  $n - 1$ , i.e., the graph contains all possible edges between the nodes.

In a directed graph, the **indegree** of a node is the number of edges that end at the node, and the **outdegree** of a node is the number of edges that start at the node. For example, in the following graph, the indegree of node 2 is 2, and the outdegree of node 2 is 1.

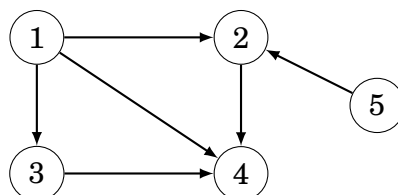

## Colorings

In a **coloring** of a graph, each node is assigned a color so that no adjacent nodes have the same color.

A graph is **bipartite** if it is possible to color it using two colors. It turns out that a graph is bipartite exactly when it does not contain a cycle with an odd number of edges. For example, the graph

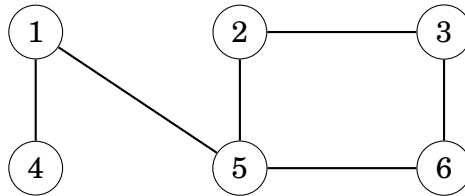

is bipartite, because it can be colored as follows:

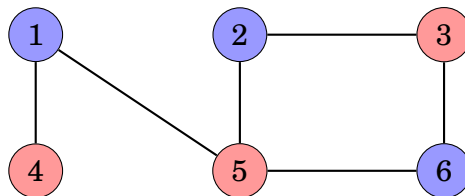

However, the graph

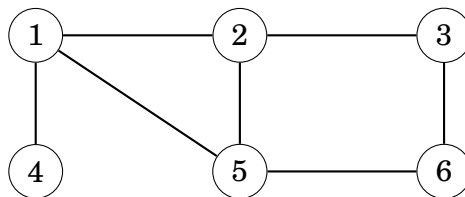

is not bipartite, because it is not possible to color the following cycle of three nodes using two colors:

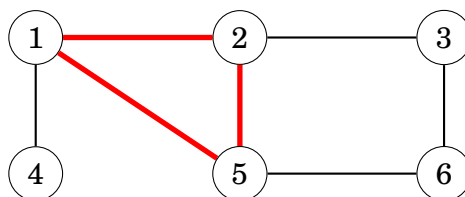

## Simplicity

A graph is **simple** if no edge starts and ends at the same node, and there are no multiple edges between two nodes. Often we assume that graphs are simple. For example, the following graph is *not* simple:

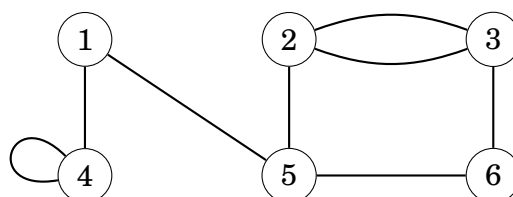

## 11.2 Graph representation

There are several ways to represent graphs in algorithms. The choice of a data structure depends on the size of the graph and the way the algorithm processes it. Next we will go through three common representations.

### Adjacency list representation

In the adjacency list representation, each node  $x$  in the graph is assigned an **adjacency list** that consists of nodes to which there is an edge from  $x$ . Adjacency lists are the most popular way to represent graphs, and most algorithms can be efficiently implemented using them.

A convenient way to store the adjacency lists is to declare an array of vectors as follows:

```
vector<int> adj[N];
```

The constant  $N$  is chosen so that all adjacency lists can be stored. For example, the graph

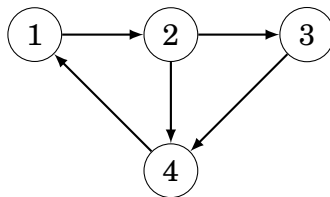

can be stored as follows:

```
adj[1].push_back(2);  
adj[2].push_back(3);  
adj[2].push_back(4);  
adj[3].push_back(4);  
adj[4].push_back(1);
```

If the graph is undirected, it can be stored in a similar way, but each edge is added in both directions.

For a weighted graph, the structure can be extended as follows:

```
vector<pair<int,int>> adj[N];
```

In this case, the adjacency list of node  $a$  contains the pair  $(b, w)$  always when there is an edge from node  $a$  to node  $b$  with weight  $w$ . For example, the graph

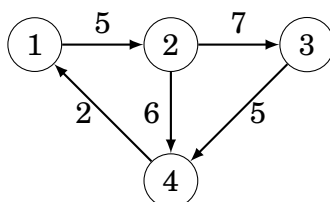

can be stored as follows:

```
adj[1].push_back({2,5});
adj[2].push_back({3,7});
adj[2].push_back({4,6});
adj[3].push_back({4,5});
adj[4].push_back({1,2});
```

The benefit of using adjacency lists is that we can efficiently find the nodes to which we can move from a given node through an edge. For example, the following loop goes through all nodes to which we can move from node  $s$ :

```
for (auto u : adj[s]) {
    // process node u
}
```

## Adjacency matrix representation

An **adjacency matrix** is a two-dimensional array that indicates which edges the graph contains. We can efficiently check from an adjacency matrix if there is an edge between two nodes. The matrix can be stored as an array

```
int adj[N][N];
```

where each value  $adj[a][b]$  indicates whether the graph contains an edge from node  $a$  to node  $b$ . If the edge is included in the graph, then  $adj[a][b] = 1$ , and otherwise  $adj[a][b] = 0$ . For example, the graph

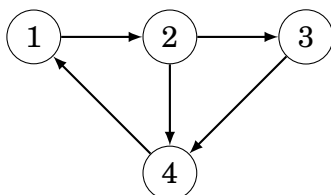

can be represented as follows:

|   | 1 | 2 | 3 | 4 |
|---|---|---|---|---|
| 1 | 0 | 1 | 0 | 0 |
| 2 | 0 | 0 | 1 | 1 |
| 3 | 0 | 0 | 0 | 1 |
| 4 | 1 | 0 | 0 | 0 |

If the graph is weighted, the adjacency matrix representation can be extended so that the matrix contains the weight of the edge if the edge exists. Using this representation, the graph

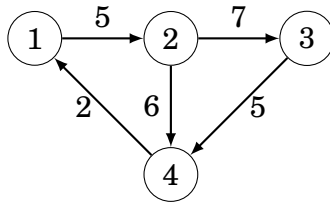

corresponds to the following matrix:

|   | 1 | 2 | 3 | 4 |
|---|---|---|---|---|
| 1 | 0 | 5 | 0 | 0 |
| 2 | 0 | 0 | 7 | 6 |
| 3 | 0 | 0 | 0 | 5 |
| 4 | 2 | 0 | 0 | 0 |

The drawback of the adjacency matrix representation is that the matrix contains  $n^2$  elements, and usually most of them are zero. For this reason, the representation cannot be used if the graph is large.

## Edge list representation

An **edge list** contains all edges of a graph in some order. This is a convenient way to represent a graph if the algorithm processes all edges of the graph and it is not needed to find edges that start at a given node.

The edge list can be stored in a vector

```
vector<pair<int,int>> edges;
```

where each pair  $(a, b)$  denotes that there is an edge from node  $a$  to node  $b$ . Thus, the graph

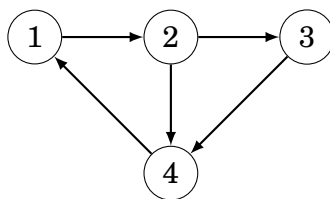

can be represented as follows:

```
edges.push_back({1,2});
edges.push_back({2,3});
edges.push_back({2,4});
edges.push_back({3,4});
edges.push_back({4,1});
```

If the graph is weighted, the structure can be extended as follows:

```
vector<tuple<int,int,int>> edges;
```

Each element in this list is of the form  $(a,b,w)$ , which means that there is an edge from node  $a$  to node  $b$  with weight  $w$ . For example, the graph

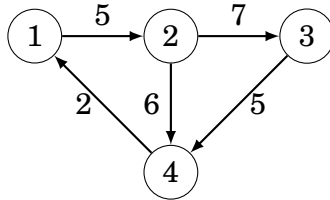

can be represented as follows<sup>1</sup>:

```
edges.push_back({1,2,5});  
edges.push_back({2,3,7});  
edges.push_back({2,4,6});  
edges.push_back({3,4,5});  
edges.push_back({4,1,2});
```

---

<sup>1</sup>In some older compilers, the function `make_tuple` must be used instead of the braces (for example, `make_tuple(1,2,5)` instead of `{1,2,5}`).

# Chapter 12

## Graph traversal

This chapter discusses two fundamental graph algorithms: depth-first search and breadth-first search. Both algorithms are given a starting node in the graph, and they visit all nodes that can be reached from the starting node. The difference in the algorithms is the order in which they visit the nodes.

### 12.1 Depth-first search

**Depth-first search** (DFS) is a straightforward graph traversal technique. The algorithm begins at a starting node, and proceeds to all other nodes that are reachable from the starting node using the edges of the graph.

Depth-first search always follows a single path in the graph as long as it finds new nodes. After this, it returns to previous nodes and begins to explore other parts of the graph. The algorithm keeps track of visited nodes, so that it processes each node only once.

#### Example

Let us consider how depth-first search processes the following graph:

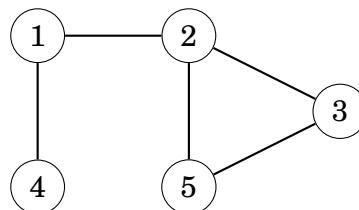

We may begin the search at any node of the graph; now we will begin the search at node 1.

The search first proceeds to node 2:

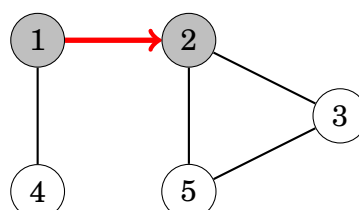

After this, nodes 3 and 5 will be visited:

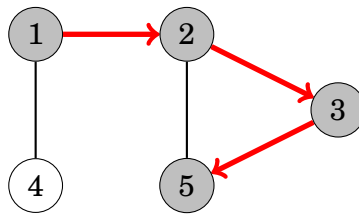

The neighbors of node 5 are 2 and 3, but the search has already visited both of them, so it is time to return to the previous nodes. Also the neighbors of nodes 3 and 2 have been visited, so we next move from node 1 to node 4:

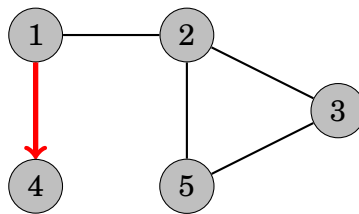

After this, the search terminates because it has visited all nodes.

The time complexity of depth-first search is  $O(n + m)$  where  $n$  is the number of nodes and  $m$  is the number of edges, because the algorithm processes each node and edge once.

## Implementation

Depth-first search can be conveniently implemented using recursion. The following function `dfs` begins a depth-first search at a given node. The function assumes that the graph is stored as adjacency lists in an array

```
vector<int> adj[N];
```

and also maintains an array

```
bool visited[N];
```

that keeps track of the visited nodes. Initially, each array value is false, and when the search arrives at node  $s$ , the value of `visited[s]` becomes true. The function can be implemented as follows:

```
void dfs(int s) {
    if (visited[s]) return;
    visited[s] = true;
    // process node s
    for (auto u: adj[s]) {
        dfs(u);
    }
}
```



## 12.2 Breadth-first search

**Breadth-first search** (BFS) visits the nodes in increasing order of their distance from the starting node. Thus, we can calculate the distance from the starting node to all other nodes using breadth-first search. However, breadth-first search is more difficult to implement than depth-first search.

Breadth-first search goes through the nodes one level after another. First the search explores the nodes whose distance from the starting node is 1, then the nodes whose distance is 2, and so on. This process continues until all nodes have been visited.

### Example

Let us consider how breadth-first search processes the following graph:

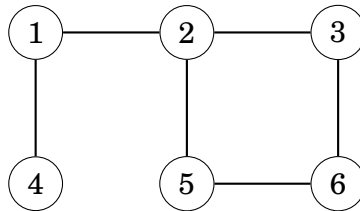

Suppose that the search begins at node 1. First, we process all nodes that can be reached from node 1 using a single edge:

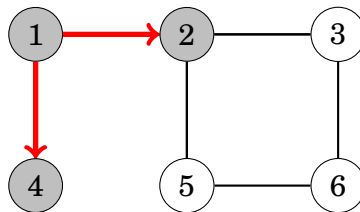

After this, we proceed to nodes 3 and 5:

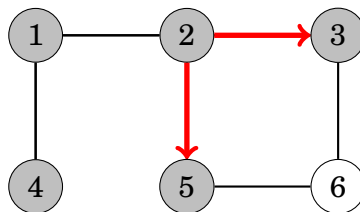

Finally, we visit node 6:

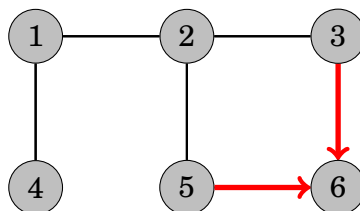

Now we have calculated the distances from the starting node to all nodes of the graph. The distances are as follows:

| node | distance |
|------|----------|
| 1    | 0        |
| 2    | 1        |
| 3    | 2        |
| 4    | 1        |
| 5    | 2        |
| 6    | 3        |

Like in depth-first search, the time complexity of breadth-first search is  $O(n + m)$ , where  $n$  is the number of nodes and  $m$  is the number of edges.

## Implementation

Breadth-first search is more difficult to implement than depth-first search, because the algorithm visits nodes in different parts of the graph. A typical implementation is based on a queue that contains nodes. At each step, the next node in the queue will be processed.

The following code assumes that the graph is stored as adjacency lists and maintains the following data structures:

```
queue<int> q;
bool visited[N];
int distance[N];
```

The queue  $q$  contains nodes to be processed in increasing order of their distance. New nodes are always added to the end of the queue, and the node at the beginning of the queue is the next node to be processed. The array `visited` indicates which nodes the search has already visited, and the array `distance` will contain the distances from the starting node to all nodes of the graph.

The search can be implemented as follows, starting at node  $x$ :

```
visited[x] = true;
distance[x] = 0;
q.push(x);
while (!q.empty()) {
    int s = q.front(); q.pop();
    // process node s
    for (auto u : adj[s]) {
        if (visited[u]) continue;
        visited[u] = true;
        distance[u] = distance[s]+1;
        q.push(u);
    }
}
```

## 12.3 Applications

Using the graph traversal algorithms, we can check many properties of graphs. Usually, both depth-first search and breadth-first search may be used, but in practice, depth-first search is a better choice, because it is easier to implement. In the following applications we will assume that the graph is undirected.

### Connectivity check

A graph is connected if there is a path between any two nodes of the graph. Thus, we can check if a graph is connected by starting at an arbitrary node and finding out if we can reach all other nodes.

For example, in the graph

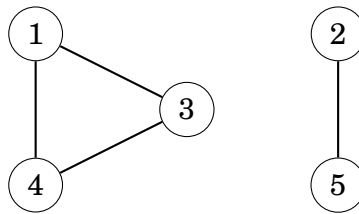

a depth-first search from node 1 visits the following nodes:

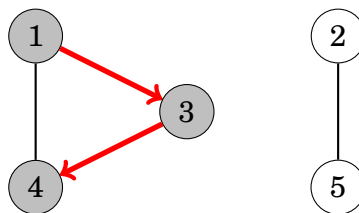

Since the search did not visit all the nodes, we can conclude that the graph is not connected. In a similar way, we can also find all connected components of a graph by iterating through the nodes and always starting a new depth-first search if the current node does not belong to any component yet.

### Finding cycles

A graph contains a cycle if during a graph traversal, we find a node whose neighbor (other than the previous node in the current path) has already been visited. For example, the graph

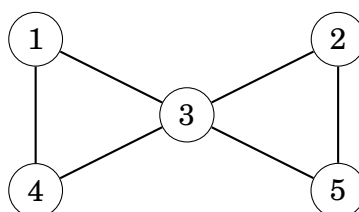

contains two cycles and we can find one of them as follows:

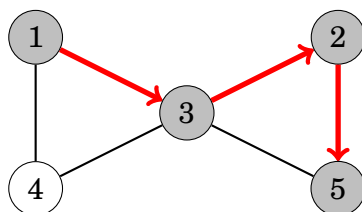

After moving from node 2 to node 5 we notice that the neighbor 3 of node 5 has already been visited. Thus, the graph contains a cycle that goes through node 3, for example,  $3 \rightarrow 2 \rightarrow 5 \rightarrow 3$ .

Another way to find out whether a graph contains a cycle is to simply calculate the number of nodes and edges in every component. If a component contains  $c$  nodes and no cycle, it must contain exactly  $c - 1$  edges (so it has to be a tree). If there are  $c$  or more edges, the component surely contains a cycle.

## Bipartiteness check

A graph is bipartite if its nodes can be colored using two colors so that there are no adjacent nodes with the same color. It is surprisingly easy to check if a graph is bipartite using graph traversal algorithms.

The idea is to color the starting node blue, all its neighbors red, all their neighbors blue, and so on. If at some point of the search we notice that two adjacent nodes have the same color, this means that the graph is not bipartite. Otherwise the graph is bipartite and one coloring has been found.

For example, the graph

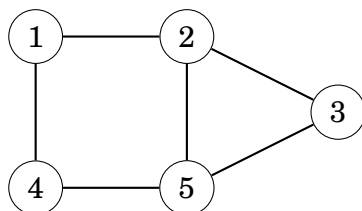

is not bipartite, because a search from node 1 proceeds as follows:

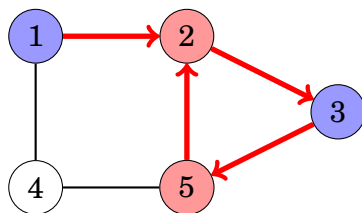

We notice that the color of both nodes 2 and 5 is red, while they are adjacent nodes in the graph. Thus, the graph is not bipartite.

This algorithm always works, because when there are only two colors available, the color of the starting node in a component determines the colors of all other nodes in the component. It does not make any difference whether the starting node is red or blue.

Note that in the general case, it is difficult to find out if the nodes in a graph can be colored using  $k$  colors so that no adjacent nodes have the same color. Even when  $k = 3$ , no efficient algorithm is known but the problem is NP-hard.

# Chapter 13

## Shortest paths

Finding a shortest path between two nodes of a graph is an important problem that has many practical applications. For example, a natural problem related to a road network is to calculate the shortest possible length of a route between two cities, given the lengths of the roads.

In an unweighted graph, the length of a path equals the number of its edges, and we can simply use breadth-first search to find a shortest path. However, in this chapter we focus on weighted graphs where more sophisticated algorithms are needed for finding shortest paths.

### 13.1 Bellman–Ford algorithm

The **Bellman–Ford algorithm**<sup>1</sup> finds shortest paths from a starting node to all nodes of the graph. The algorithm can process all kinds of graphs, provided that the graph does not contain a cycle with negative length. If the graph contains a negative cycle, the algorithm can detect this.

The algorithm keeps track of distances from the starting node to all nodes of the graph. Initially, the distance to the starting node is 0 and the distance to all other nodes is infinite. The algorithm reduces the distances by finding edges that shorten the paths until it is not possible to reduce any distance.

#### Example

Let us consider how the Bellman–Ford algorithm works in the following graph:

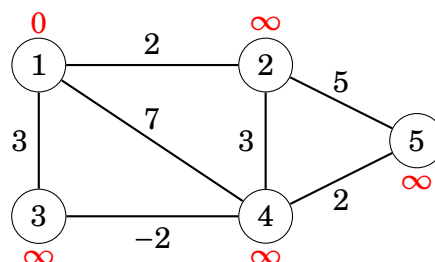

<sup>1</sup>The algorithm is named after R. E. Bellman and L. R. Ford who published it independently in 1958 and 1956, respectively [5, 24].

Each node of the graph is assigned a distance. Initially, the distance to the starting node is 0, and the distance to all other nodes is infinite.

The algorithm searches for edges that reduce distances. First, all edges from node 1 reduce distances:

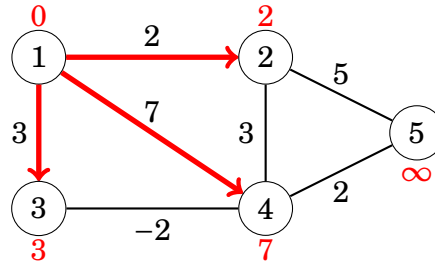

After this, edges  $2 \rightarrow 5$  and  $3 \rightarrow 4$  reduce distances:

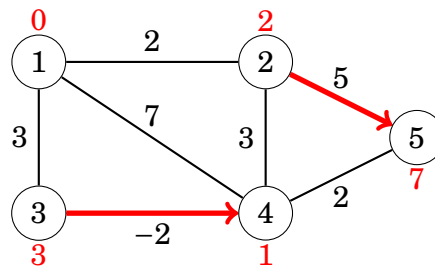

Finally, there is one more change:

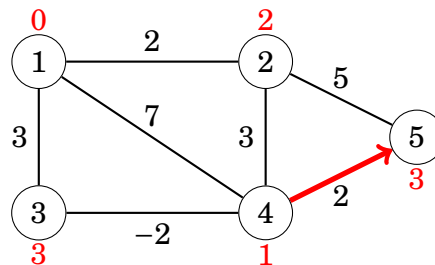

After this, no edge can reduce any distance. This means that the distances are final, and we have successfully calculated the shortest distances from the starting node to all nodes of the graph.

For example, the shortest distance 3 from node 1 to node 5 corresponds to the following path:

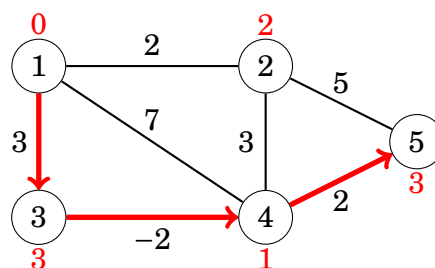

## Implementation

The following implementation of the Bellman–Ford algorithm determines the shortest distances from a node  $x$  to all nodes of the graph. The code assumes that the graph is stored as an edge list edges that consists of tuples of the form  $(a, b, w)$ , meaning that there is an edge from node  $a$  to node  $b$  with weight  $w$ .

The algorithm consists of  $n - 1$  rounds, and on each round the algorithm goes through all edges of the graph and tries to reduce the distances. The algorithm constructs an array distance that will contain the distances from  $x$  to all nodes of the graph. The constant INF denotes an infinite distance.

```
for (int i = 1; i <= n; i++) distance[i] = INF;
distance[x] = 0;
for (int i = 1; i <= n-1; i++) {
    for (auto e : edges) {
        int a, b, w;
        tie(a, b, w) = e;
        distance[b] = min(distance[b], distance[a]+w);
    }
}
```

The time complexity of the algorithm is  $O(nm)$ , because the algorithm consists of  $n - 1$  rounds and iterates through all  $m$  edges during a round. If there are no negative cycles in the graph, all distances are final after  $n - 1$  rounds, because each shortest path can contain at most  $n - 1$  edges.

In practice, the final distances can usually be found faster than in  $n - 1$  rounds. Thus, a possible way to make the algorithm more efficient is to stop the algorithm if no distance can be reduced during a round.

## Negative cycles

The Bellman–Ford algorithm can also be used to check if the graph contains a cycle with negative length. For example, the graph

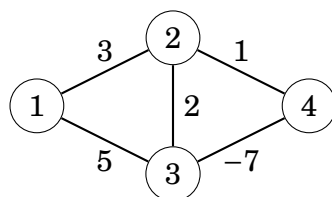

contains a negative cycle  $2 \rightarrow 3 \rightarrow 4 \rightarrow 2$  with length  $-4$ .

If the graph contains a negative cycle, we can shorten infinitely many times any path that contains the cycle by repeating the cycle again and again. Thus, the concept of a shortest path is not meaningful in this situation.

A negative cycle can be detected using the Bellman–Ford algorithm by running the algorithm for  $n$  rounds. If the last round reduces any distance, the graph contains a negative cycle. Note that this algorithm can be used to search for a negative cycle in the whole graph regardless of the starting node.

## SPFA algorithm

The **SPFA algorithm** (“Shortest Path Faster Algorithm”) [20] is a variant of the Bellman–Ford algorithm, that is often more efficient than the original algorithm. The SPFA algorithm does not go through all the edges on each round, but instead, it chooses the edges to be examined in a more intelligent way.

The algorithm maintains a queue of nodes that might be used for reducing the distances. First, the algorithm adds the starting node  $x$  to the queue. Then, the algorithm always processes the first node in the queue, and when an edge  $a \rightarrow b$  reduces a distance, node  $b$  is added to the queue.

The efficiency of the SPFA algorithm depends on the structure of the graph: the algorithm is often efficient, but its worst case time complexity is still  $O(nm)$  and it is possible to create inputs that make the algorithm as slow as the original Bellman–Ford algorithm.

## 13.2 Dijkstra’s algorithm

**Dijkstra’s algorithm**<sup>2</sup> finds shortest paths from the starting node to all nodes of the graph, like the Bellman–Ford algorithm. The benefit of Dijkstra’s algorithm is that it is more efficient and can be used for processing large graphs. However, the algorithm requires that there are no negative weight edges in the graph.

Like the Bellman–Ford algorithm, Dijkstra’s algorithm maintains distances to the nodes and reduces them during the search. Dijkstra’s algorithm is efficient, because it only processes each edge in the graph once, using the fact that there are no negative edges.

### Example

Let us consider how Dijkstra’s algorithm works in the following graph when the starting node is node 1:

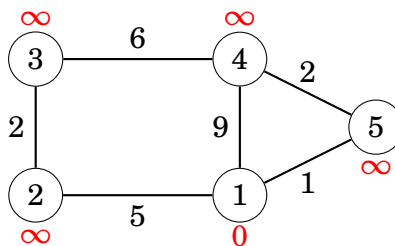

Like in the Bellman–Ford algorithm, initially the distance to the starting node is 0 and the distance to all other nodes is infinite.

At each step, Dijkstra’s algorithm selects a node that has not been processed yet and whose distance is as small as possible. The first such node is node 1 with distance 0.

---

<sup>2</sup>E. W. Dijkstra published the algorithm in 1959 [14]; however, his original paper does not mention how to implement the algorithm efficiently.



When a node is selected, the algorithm goes through all edges that start at the node and reduces the distances using them:

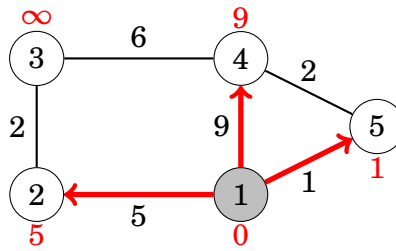

In this case, the edges from node 1 reduced the distances of nodes 2, 4 and 5, whose distances are now 5, 9 and 1.

The next node to be processed is node 5 with distance 1. This reduces the distance to node 4 from 9 to 3:

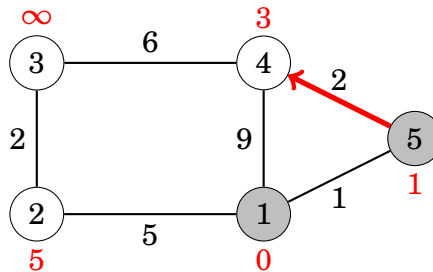

After this, the next node is node 4, which reduces the distance to node 3 to 9:

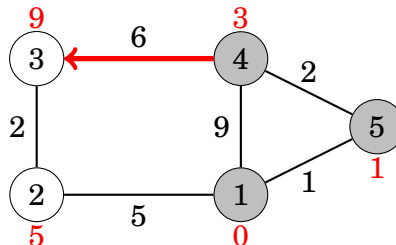

A remarkable property in Dijkstra's algorithm is that whenever a node is selected, its distance is final. For example, at this point of the algorithm, the distances 0, 1 and 3 are the final distances to nodes 1, 5 and 4.

After this, the algorithm processes the two remaining nodes, and the final distances are as follows:

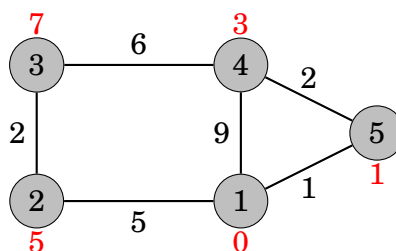

## Negative edges

The efficiency of Dijkstra's algorithm is based on the fact that the graph does not contain negative edges. If there is a negative edge, the algorithm may give incorrect results. As an example, consider the following graph:

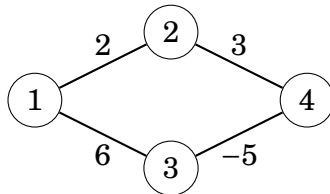

The shortest path from node 1 to node 4 is  $1 \rightarrow 3 \rightarrow 4$  and its length is 1. However, Dijkstra's algorithm finds the path  $1 \rightarrow 2 \rightarrow 4$  by following the minimum weight edges. The algorithm does not take into account that on the other path, the weight  $-5$  compensates the previous large weight 6.

## Implementation

The following implementation of Dijkstra's algorithm calculates the minimum distances from a node  $x$  to other nodes of the graph. The graph is stored as adjacency lists so that  $\text{adj}[a]$  contains a pair  $(b, w)$  always when there is an edge from node  $a$  to node  $b$  with weight  $w$ .

An efficient implementation of Dijkstra's algorithm requires that it is possible to efficiently find the minimum distance node that has not been processed. An appropriate data structure for this is a priority queue that contains the nodes ordered by their distances. Using a priority queue, the next node to be processed can be retrieved in logarithmic time.

In the following code, the priority queue  $q$  contains pairs of the form  $(-d, x)$ , meaning that the current distance to node  $x$  is  $d$ . The array  $\text{distance}$  contains the distance to each node, and the array  $\text{processed}$  indicates whether a node has been processed. Initially the distance is 0 to  $x$  and  $\infty$  to all other nodes.

```
for (int i = 1; i <= n; i++) distance[i] = INF;
distance[x] = 0;
q.push({0,x});
while (!q.empty()) {
    int a = q.top().second; q.pop();
    if (processed[a]) continue;
    processed[a] = true;
    for (auto u : adj[a]) {
        int b = u.first, w = u.second;
        if (distance[a]+w < distance[b]) {
            distance[b] = distance[a]+w;
            q.push({-distance[b],b});
        }
    }
}
```

Note that the priority queue contains *negative* distances to nodes. The reason for this is that the default version of the C++ priority queue finds maximum elements, while we want to find minimum elements. By using negative distances, we can directly use the default priority queue<sup>3</sup>. Also note that there may be several instances of the same node in the priority queue; however, only the instance with the minimum distance will be processed.

The time complexity of the above implementation is  $O(n + m \log m)$ , because the algorithm goes through all nodes of the graph and adds for each edge at most one distance to the priority queue.

### 13.3 Floyd–Warshall algorithm

The **Floyd–Warshall algorithm**<sup>4</sup> provides an alternative way to approach the problem of finding shortest paths. Unlike the other algorithms of this chapter, it finds all shortest paths between the nodes in a single run.

The algorithm maintains a two-dimensional array that contains distances between the nodes. First, distances are calculated only using direct edges between the nodes, and after this, the algorithm reduces distances by using intermediate nodes in paths.

#### Example

Let us consider how the Floyd–Warshall algorithm works in the following graph:

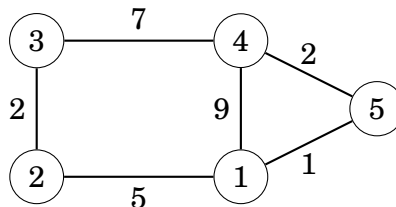

Initially, the distance from each node to itself is 0, and the distance between nodes  $a$  and  $b$  is  $x$  if there is an edge between nodes  $a$  and  $b$  with weight  $x$ . All other distances are infinite.

In this graph, the initial array is as follows:

|   | 1        | 2        | 3        | 4        | 5        |
|---|----------|----------|----------|----------|----------|
| 1 | 0        | 5        | $\infty$ | 9        | 1        |
| 2 | 5        | 0        | 2        | $\infty$ | $\infty$ |
| 3 | $\infty$ | 2        | 0        | 7        | $\infty$ |
| 4 | 9        | $\infty$ | 7        | 0        | 2        |
| 5 | 1        | $\infty$ | $\infty$ | 2        | 0        |

<sup>3</sup>Of course, we could also declare the priority queue as in Chapter 4.5 and use positive distances, but the implementation would be a bit longer.

<sup>4</sup>The algorithm is named after R. W. Floyd and S. Warshall who published it independently in 1962 [23, 70].

The algorithm consists of consecutive rounds. On each round, the algorithm selects a new node that can act as an intermediate node in paths from now on, and distances are reduced using this node.

On the first round, node 1 is the new intermediate node. There is a new path between nodes 2 and 4 with length 14, because node 1 connects them. There is also a new path between nodes 2 and 5 with length 6.

|   | 1        | 2         | 3        | 4         | 5        |
|---|----------|-----------|----------|-----------|----------|
| 1 | 0        | 5         | $\infty$ | 9         | 1        |
| 2 | 5        | 0         | 2        | <b>14</b> | <b>6</b> |
| 3 | $\infty$ | 2         | 0        | 7         | $\infty$ |
| 4 | 9        | <b>14</b> | 7        | 0         | 2        |
| 5 | 1        | <b>6</b>  | $\infty$ | 2         | 0        |

On the second round, node 2 is the new intermediate node. This creates new paths between nodes 1 and 3 and between nodes 3 and 5:

|   | 1        | 2  | 3        | 4  | 5        |
|---|----------|----|----------|----|----------|
| 1 | 0        | 5  | <b>7</b> | 9  | 1        |
| 2 | 5        | 0  | 2        | 14 | 6        |
| 3 | <b>7</b> | 2  | 0        | 7  | <b>8</b> |
| 4 | 9        | 14 | 7        | 0  | 2        |
| 5 | 1        | 6  | <b>8</b> | 2  | 0        |

On the third round, node 3 is the new intermediate round. There is a new path between nodes 2 and 4:

|   | 1 | 2        | 3 | 4        | 5 |
|---|---|----------|---|----------|---|
| 1 | 0 | 5        | 7 | 9        | 1 |
| 2 | 5 | 0        | 2 | <b>9</b> | 6 |
| 3 | 7 | 2        | 0 | 7        | 8 |
| 4 | 9 | <b>9</b> | 7 | 0        | 2 |
| 5 | 1 | 6        | 8 | 2        | 0 |

The algorithm continues like this, until all nodes have been appointed intermediate nodes. After the algorithm has finished, the array contains the minimum distances between any two nodes:

|   | 1 | 2 | 3 | 4 | 5 |
|---|---|---|---|---|---|
| 1 | 0 | 5 | 7 | 3 | 1 |
| 2 | 5 | 0 | 2 | 8 | 6 |
| 3 | 7 | 2 | 0 | 7 | 8 |
| 4 | 3 | 8 | 7 | 0 | 2 |
| 5 | 1 | 6 | 8 | 2 | 0 |

For example, the array tells us that the shortest distance between nodes 2 and 4 is 8. This corresponds to the following path:

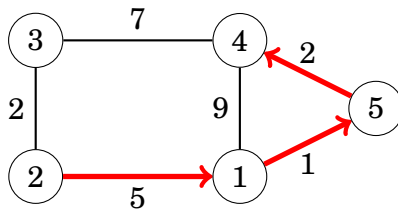

## Implementation

The advantage of the Floyd–Warshall algorithm is that it is easy to implement. The following code constructs a distance matrix where  $\text{distance}[a][b]$  is the shortest distance between nodes  $a$  and  $b$ . First, the algorithm initializes distance using the adjacency matrix  $\text{adj}$  of the graph:

```

for (int i = 1; i <= n; i++) {
    for (int j = 1; j <= n; j++) {
        if (i == j) distance[i][j] = 0;
        else if (adj[i][j]) distance[i][j] = adj[i][j];
        else distance[i][j] = INF;
    }
}

```

After this, the shortest distances can be found as follows:

```

for (int k = 1; k <= n; k++) {
    for (int i = 1; i <= n; i++) {
        for (int j = 1; j <= n; j++) {
            distance[i][j] = min(distance[i][j],
                                distance[i][k]+distance[k][j]);
        }
    }
}

```

The time complexity of the algorithm is  $O(n^3)$ , because it contains three nested loops that go through the nodes of the graph.

Since the implementation of the Floyd–Warshall algorithm is simple, the algorithm can be a good choice even if it is only needed to find a single shortest path in the graph. However, the algorithm can only be used when the graph is so small that a cubic time complexity is fast enough.



# Chapter 14

## Tree algorithms

A **tree** is a connected, acyclic graph that consists of  $n$  nodes and  $n - 1$  edges. Removing any edge from a tree divides it into two components, and adding any edge to a tree creates a cycle. Moreover, there is always a unique path between any two nodes of a tree.

For example, the following tree consists of 8 nodes and 7 edges:

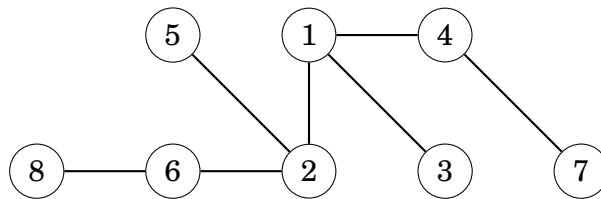

The **leaves** of a tree are the nodes with degree 1, i.e., with only one neighbor. For example, the leaves of the above tree are nodes 3, 5, 7 and 8.

In a **rooted** tree, one of the nodes is appointed the **root** of the tree, and all other nodes are placed underneath the root. For example, in the following tree, node 1 is the root node.

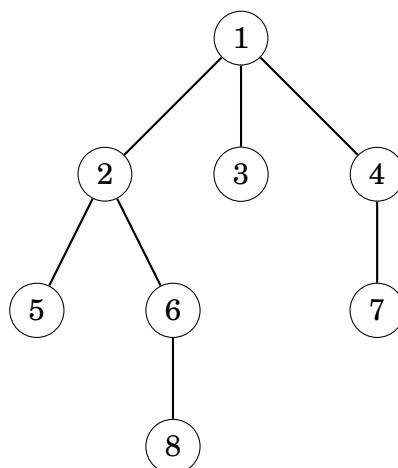

In a rooted tree, the **children** of a node are its lower neighbors, and the **parent** of a node is its upper neighbor. Each node has exactly one parent, except for the root that does not have a parent. For example, in the above tree, the children of node 2 are nodes 5 and 6, and its parent is node 1.

The structure of a rooted tree is *recursive*: each node of the tree acts as the root of a **subtree** that contains the node itself and all nodes that are in the subtrees of its children. For example, in the above tree, the subtree of node 2 consists of nodes 2, 5, 6 and 8:

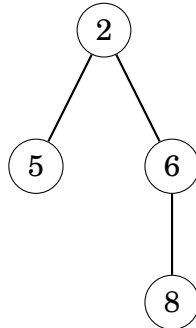

## 14.1 Tree traversal

General graph traversal algorithms can be used to traverse the nodes of a tree. However, the traversal of a tree is easier to implement than that of a general graph, because there are no cycles in the tree and it is not possible to reach a node from multiple directions.

The typical way to traverse a tree is to start a depth-first search at an arbitrary node. The following recursive function can be used:

```
void dfs(int s, int e) {  
    // process node s  
    for (auto u : adj[s]) {  
        if (u != e) dfs(u, s);  
    }  
}
```

The function is given two parameters: the current node  $s$  and the previous node  $e$ . The purpose of the parameter  $e$  is to make sure that the search only moves to nodes that have not been visited yet.

The following function call starts the search at node  $x$ :

```
dfs(x, 0);
```

In the first call  $e = 0$ , because there is no previous node, and it is allowed to proceed to any direction in the tree.

## Dynamic programming

Dynamic programming can be used to calculate some information during a tree traversal. Using dynamic programming, we can, for example, calculate in  $O(n)$  time for each node of a rooted tree the number of nodes in its subtree or the length of the longest path from the node to a leaf.



As an example, let us calculate for each node  $s$  a value  $\text{count}[s]$ : the number of nodes in its subtree. The subtree contains the node itself and all nodes in the subtrees of its children, so we can calculate the number of nodes recursively using the following code:

```
void dfs(int s, int e) {
    count[s] = 1;
    for (auto u : adj[s]) {
        if (u == e) continue;
        dfs(u, s);
        count[s] += count[u];
    }
}
```

## 14.2 Diameter

The **diameter** of a tree is the maximum length of a path between two nodes. For example, consider the following tree:

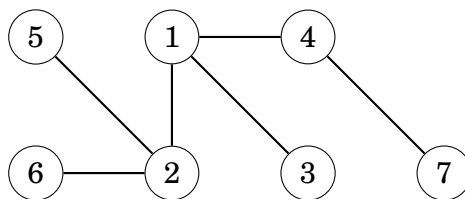

The diameter of this tree is 4, which corresponds to the following path:

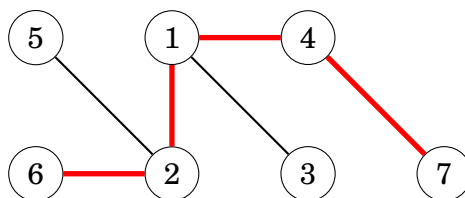

Note that there may be several maximum-length paths. In the above path, we could replace node 6 with node 5 to obtain another path with length 4.

Next we will discuss two  $O(n)$  time algorithms for calculating the diameter of a tree. The first algorithm is based on dynamic programming, and the second algorithm uses two depth-first searches.

### Algorithm 1

A general way to approach many tree problems is to first root the tree arbitrarily. After this, we can try to solve the problem separately for each subtree. Our first algorithm for calculating the diameter is based on this idea.

An important observation is that every path in a rooted tree has a *highest point*: the highest node that belongs to the path. Thus, we can calculate for each

node the length of the longest path whose highest point is the node. One of those paths corresponds to the diameter of the tree.

For example, in the following tree, node 1 is the highest point on the path that corresponds to the diameter:

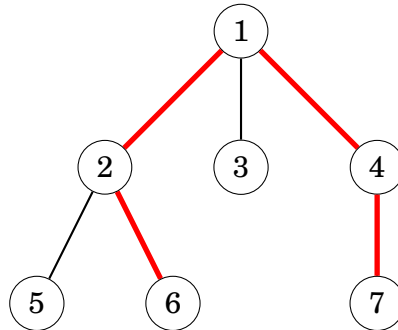

We calculate for each node  $x$  two values:

- $\text{toLeaf}(x)$ : the maximum length of a path from  $x$  to any leaf
- $\text{maxLength}(x)$ : the maximum length of a path whose highest point is  $x$

For example, in the above tree,  $\text{toLeaf}(1) = 2$ , because there is a path  $1 \rightarrow 2 \rightarrow 6$ , and  $\text{maxLength}(1) = 4$ , because there is a path  $6 \rightarrow 2 \rightarrow 1 \rightarrow 4 \rightarrow 7$ . In this case,  $\text{maxLength}(1)$  equals the diameter.

Dynamic programming can be used to calculate the above values for all nodes in  $O(n)$  time. First, to calculate  $\text{toLeaf}(x)$ , we go through the children of  $x$ , choose a child  $c$  with maximum  $\text{toLeaf}(c)$  and add one to this value. Then, to calculate  $\text{maxLength}(x)$ , we choose two distinct children  $a$  and  $b$  such that the sum  $\text{toLeaf}(a) + \text{toLeaf}(b)$  is maximum and add two to this sum.

## Algorithm 2

Another efficient way to calculate the diameter of a tree is based on two depth-first searches. First, we choose an arbitrary node  $a$  in the tree and find the farthest node  $b$  from  $a$ . Then, we find the farthest node  $c$  from  $b$ . The diameter of the tree is the distance between  $b$  and  $c$ .

In the following graph,  $a$ ,  $b$  and  $c$  could be:

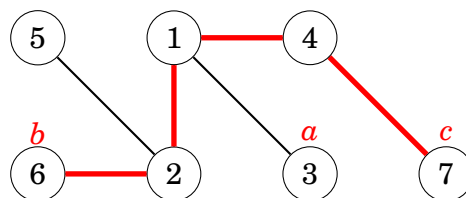

This is an elegant method, but why does it work?

It helps to draw the tree differently so that the path that corresponds to the diameter is horizontal, and all other nodes hang from it:

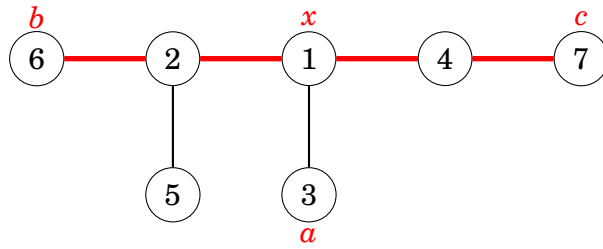

Node  $x$  indicates the place where the path from node  $a$  joins the path that corresponds to the diameter. The farthest node from  $a$  is node  $b$ , node  $c$  or some other node that is at least as far from node  $x$ . Thus, this node is always a valid choice for an endpoint of a path that corresponds to the diameter.

### 14.3 All longest paths

Our next problem is to calculate for every node in the tree the maximum length of a path that begins at the node. This can be seen as a generalization of the tree diameter problem, because the largest of those lengths equals the diameter of the tree. Also this problem can be solved in  $O(n)$  time.

As an example, consider the following tree:

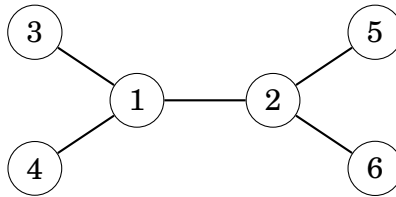

Let  $\text{maxLength}(x)$  denote the maximum length of a path that begins at node  $x$ . For example, in the above tree,  $\text{maxLength}(4) = 3$ , because there is a path  $4 \rightarrow 1 \rightarrow 2 \rightarrow 6$ . Here is a complete table of the values:

|                       |   |   |   |   |   |   |
|-----------------------|---|---|---|---|---|---|
| node $x$              | 1 | 2 | 3 | 4 | 5 | 6 |
| $\text{maxLength}(x)$ | 2 | 2 | 3 | 3 | 3 | 3 |

Also in this problem, a good starting point for solving the problem is to root the tree arbitrarily:

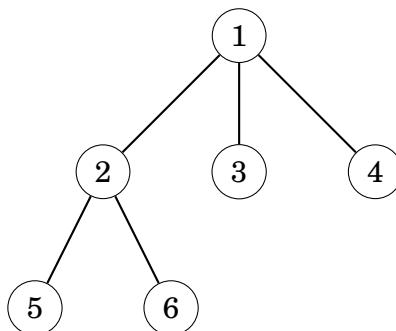

The first part of the problem is to calculate for every node  $x$  the maximum length of a path that goes through a child of  $x$ . For example, the longest path from node 1 goes through its child 2:

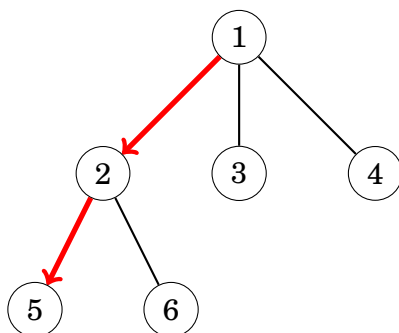

This part is easy to solve in  $O(n)$  time, because we can use dynamic programming as we have done previously.

Then, the second part of the problem is to calculate for every node  $x$  the maximum length of a path through its parent  $p$ . For example, the longest path from node 3 goes through its parent 1:

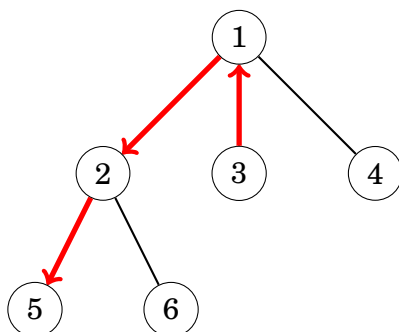

At first glance, it seems that we should choose the longest path from  $p$ . However, this *does not* always work, because the longest path from  $p$  may go through  $x$ . Here is an example of this situation:

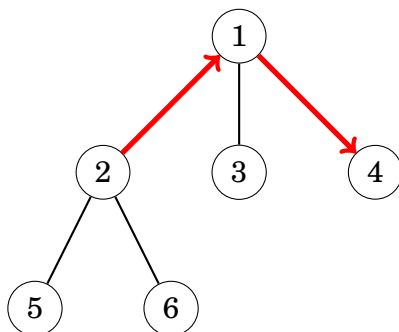

Still, we can solve the second part in  $O(n)$  time by storing *two* maximum lengths for each node  $x$ :

- $\text{maxLength}_1(x)$ : the maximum length of a path from  $x$
- $\text{maxLength}_2(x)$  the maximum length of a path from  $x$  in another direction than the first path

For example, in the above graph,  $\text{maxLength}_1(1) = 2$  using the path  $1 \rightarrow 2 \rightarrow 5$ , and  $\text{maxLength}_2(1) = 1$  using the path  $1 \rightarrow 3$ .

Finally, if the path that corresponds to  $\text{maxLength}_1(p)$  goes through  $x$ , we conclude that the maximum length is  $\text{maxLength}_2(p) + 1$ , and otherwise the maximum length is  $\text{maxLength}_1(p) + 1$ .

## 14.4 Binary trees

A **binary tree** is a rooted tree where each node has a left and right subtree. It is possible that a subtree of a node is empty. Thus, every node in a binary tree has zero, one or two children.

For example, the following tree is a binary tree:

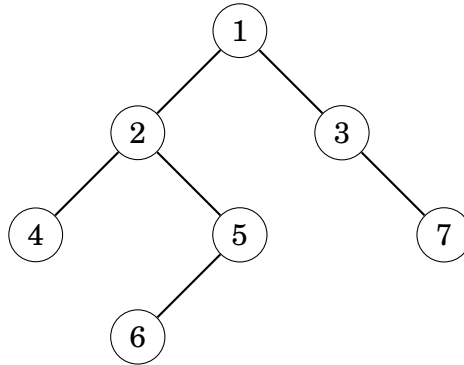

The nodes of a binary tree have three natural orderings that correspond to different ways to recursively traverse the tree:

- **pre-order**: first process the root, then traverse the left subtree, then traverse the right subtree
- **in-order**: first traverse the left subtree, then process the root, then traverse the right subtree
- **post-order**: first traverse the left subtree, then traverse the right subtree, then process the root

For the above tree, the nodes in pre-order are [1,2,4,5,6,3,7], in in-order [4,2,6,5,1,3,7] and in post-order [4,6,5,2,7,3,1].

If we know the pre-order and in-order of a tree, we can reconstruct the exact structure of the tree. For example, the above tree is the only possible tree with pre-order [1,2,4,5,6,3,7] and in-order [4,2,6,5,1,3,7]. In a similar way, the post-order and in-order also determine the structure of a tree.

However, the situation is different if we only know the pre-order and post-order of a tree. In this case, there may be more than one tree that match the orderings. For example, in both of the trees



the pre-order is [1,2] and the post-order is [2,1], but the structures of the trees are different.



# Chapter 15

## Spanning trees

A **spanning tree** of a graph consists of the nodes of the graph and some of the edges of the graph so that there is a path between any two nodes. Like trees in general, spanning trees are connected and acyclic. Usually there are several ways to construct a spanning tree.

For example, consider the following graph:

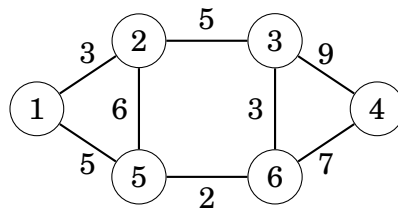

One spanning tree for the graph is as follows:

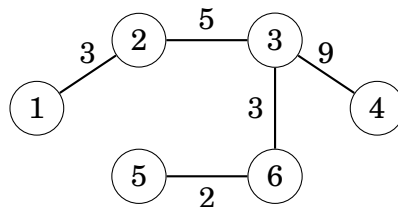

The weight of a spanning tree is the sum of its edge weights. For example, the weight of the above spanning tree is  $3 + 5 + 9 + 3 + 2 = 22$ .

A **minimum spanning tree** is a spanning tree whose weight is as small as possible. The weight of a minimum spanning tree for the example graph is 20, and such a tree can be constructed as follows:

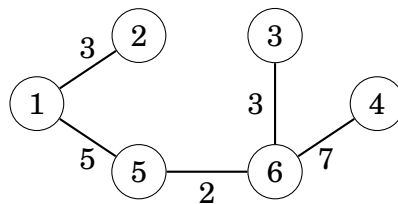

In a similar way, a **maximum spanning tree** is a spanning tree whose weight is as large as possible. The weight of a maximum spanning tree for the example graph is 32:

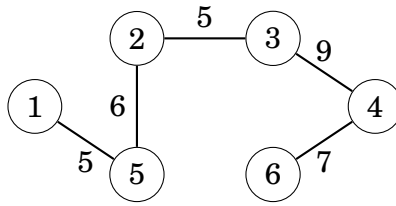

Note that a graph may have several minimum and maximum spanning trees, so the trees are not unique.

It turns out that several greedy methods can be used to construct minimum and maximum spanning trees. In this chapter, we discuss two algorithms that process the edges of the graph ordered by their weights. We focus on finding minimum spanning trees, but the same algorithms can find maximum spanning trees by processing the edges in reverse order.

## 15.1 Kruskal's algorithm

In **Kruskal's algorithm**<sup>1</sup>, the initial spanning tree only contains the nodes of the graph and does not contain any edges. Then the algorithm goes through the edges ordered by their weights, and always adds an edge to the tree if it does not create a cycle.

The algorithm maintains the components of the tree. Initially, each node of the graph belongs to a separate component. Always when an edge is added to the tree, two components are joined. Finally, all nodes belong to the same component, and a minimum spanning tree has been found.

### Example

Let us consider how Kruskal's algorithm processes the following graph:

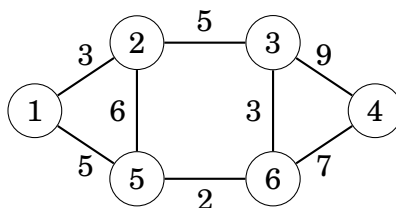

The first step of the algorithm is to sort the edges in increasing order of their weights. The result is the following list:

<sup>1</sup>The algorithm was published in 1956 by J. B. Kruskal [48].



| edge | weight |
|------|--------|
| 5-6  | 2      |
| 1-2  | 3      |
| 3-6  | 3      |
| 1-5  | 5      |
| 2-3  | 5      |
| 2-5  | 6      |
| 4-6  | 7      |
| 3-4  | 9      |

After this, the algorithm goes through the list and adds each edge to the tree if it joins two separate components.

Initially, each node is in its own component:

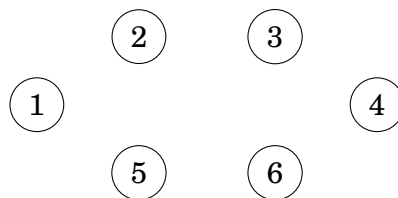

The first edge to be added to the tree is the edge 5-6 that creates a component {5,6} by joining the components {5} and {6}:

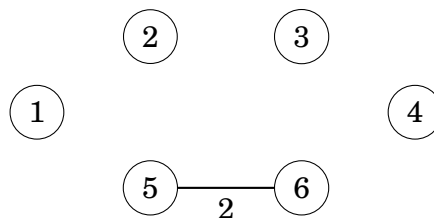

After this, the edges 1-2, 3-6 and 1-5 are added in a similar way:

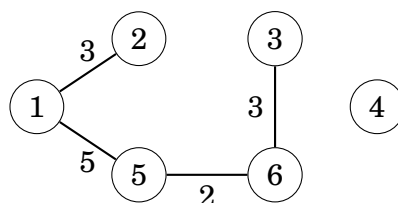

After those steps, most components have been joined and there are two components in the tree: {1,2,3,5,6} and {4}.

The next edge in the list is the edge 2-3, but it will not be included in the tree, because nodes 2 and 3 are already in the same component. For the same reason, the edge 2-5 will not be included in the tree.

Finally, the edge 4–6 will be included in the tree:

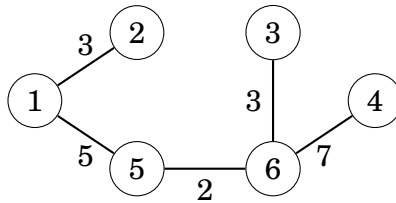

After this, the algorithm will not add any new edges, because the graph is connected and there is a path between any two nodes. The resulting graph is a minimum spanning tree with weight  $2 + 3 + 3 + 5 + 7 = 20$ .

### Why does this work?

It is a good question why Kruskal's algorithm works. Why does the greedy strategy guarantee that we will find a minimum spanning tree?

Let us see what happens if the minimum weight edge of the graph is *not* included in the spanning tree. For example, suppose that a spanning tree for the previous graph would not contain the minimum weight edge 5–6. We do not know the exact structure of such a spanning tree, but in any case it has to contain some edges. Assume that the tree would be as follows:

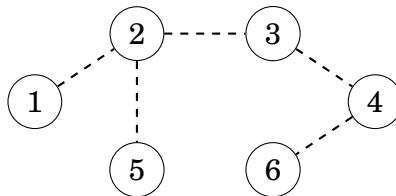

However, it is not possible that the above tree would be a minimum spanning tree for the graph. The reason for this is that we can remove an edge from the tree and replace it with the minimum weight edge 5–6. This produces a spanning tree whose weight is *smaller*:

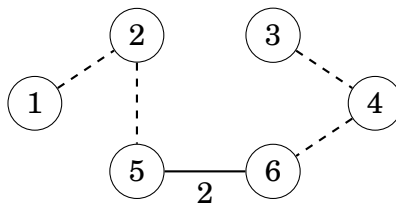

For this reason, it is always optimal to include the minimum weight edge in the tree to produce a minimum spanning tree. Using a similar argument, we can show that it is also optimal to add the next edge in weight order to the tree, and so on. Hence, Kruskal's algorithm works correctly and always produces a minimum spanning tree.

## Implementation

When implementing Kruskal's algorithm, it is convenient to use the edge list representation of the graph. The first phase of the algorithm sorts the edges in the list in  $O(m \log m)$  time. After this, the second phase of the algorithm builds the minimum spanning tree as follows:

```
for (...) {
  if (!same(a,b)) unite(a,b);
}
```

The loop goes through the edges in the list and always processes an edge  $a-b$  where  $a$  and  $b$  are two nodes. Two functions are needed: the function `same` determines if  $a$  and  $b$  are in the same component, and the function `unite` joins the components that contain  $a$  and  $b$ .

The problem is how to efficiently implement the functions `same` and `unite`. One possibility is to implement the function `same` as a graph traversal and check if we can get from node  $a$  to node  $b$ . However, the time complexity of such a function would be  $O(n + m)$  and the resulting algorithm would be slow, because the function `same` will be called for each edge in the graph.

We will solve the problem using a union-find structure that implements both functions in  $O(\log n)$  time. Thus, the time complexity of Kruskal's algorithm will be  $O(m \log n)$  after sorting the edge list.

## 15.2 Union-find structure

A **union-find structure** maintains a collection of sets. The sets are disjoint, so no element belongs to more than one set. Two  $O(\log n)$  time operations are supported: the `unite` operation joins two sets, and the `find` operation finds the representative of the set that contains a given element<sup>2</sup>.

### Structure

In a union-find structure, one element in each set is the representative of the set, and there is a chain from any other element of the set to the representative. For example, assume that the sets are  $\{1, 4, 7\}$ ,  $\{5\}$  and  $\{2, 3, 6, 8\}$ :

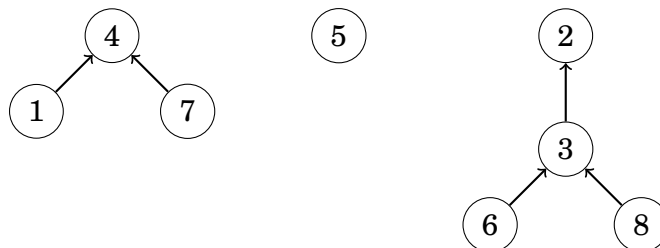

---

<sup>2</sup>The structure presented here was introduced in 1971 by J. D. Hopcroft and J. D. Ullman [38]. Later, in 1975, R. E. Tarjan studied a more sophisticated variant of the structure [64] that is discussed in many algorithm textbooks nowadays.

In this case the representatives of the sets are 4, 5 and 2. We can find the representative of any element by following the chain that begins at the element. For example, the element 2 is the representative for the element 6, because we follow the chain  $6 \rightarrow 3 \rightarrow 2$ . Two elements belong to the same set exactly when their representatives are the same.

Two sets can be joined by connecting the representative of one set to the representative of the other set. For example, the sets  $\{1, 4, 7\}$  and  $\{2, 3, 6, 8\}$  can be joined as follows:

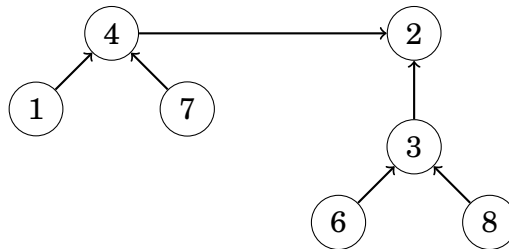

The resulting set contains the elements  $\{1, 2, 3, 4, 6, 7, 8\}$ . From this on, the element 2 is the representative for the entire set and the old representative 4 points to the element 2.

The efficiency of the union-find structure depends on how the sets are joined. It turns out that we can follow a simple strategy: always connect the representative of the *smaller* set to the representative of the *larger* set (or if the sets are of equal size, we can make an arbitrary choice). Using this strategy, the length of any chain will be  $O(\log n)$ , so we can find the representative of any element efficiently by following the corresponding chain.

## Implementation

The union-find structure can be implemented using arrays. In the following implementation, the array `link` contains for each element the next element in the chain or the element itself if it is a representative, and the array `size` indicates for each representative the size of the corresponding set.

Initially, each element belongs to a separate set:

```

for (int i = 1; i <= n; i++) link[i] = i;
for (int i = 1; i <= n; i++) size[i] = 1;
  
```

The function `find` returns the representative for an element  $x$ . The representative can be found by following the chain that begins at  $x$ .

```

int find(int x) {
    while (x != link[x]) x = link[x];
    return x;
}
  
```

The function `same` checks whether elements  $a$  and  $b$  belong to the same set. This can easily be done by using the function `find`:

```

bool same(int a, int b) {
    return find(a) == find(b);
}

```

The function `unite` joins the sets that contain elements  $a$  and  $b$  (the elements have to be in different sets). The function first finds the representatives of the sets and then connects the smaller set to the larger set.

```

void unite(int a, int b) {
    a = find(a);
    b = find(b);
    if (size[a] < size[b]) swap(a,b);
    size[a] += size[b];
    link[b] = a;
}

```

The time complexity of the function `find` is  $O(\log n)$  assuming that the length of each chain is  $O(\log n)$ . In this case, the functions `same` and `unite` also work in  $O(\log n)$  time. The function `unite` makes sure that the length of each chain is  $O(\log n)$  by connecting the smaller set to the larger set.

## 15.3 Prim's algorithm

**Prim's algorithm**<sup>3</sup> is an alternative method for finding a minimum spanning tree. The algorithm first adds an arbitrary node to the tree. After this, the algorithm always chooses a minimum-weight edge that adds a new node to the tree. Finally, all nodes have been added to the tree and a minimum spanning tree has been found.

Prim's algorithm resembles Dijkstra's algorithm. The difference is that Dijkstra's algorithm always selects an edge whose distance from the starting node is minimum, but Prim's algorithm simply selects the minimum weight edge that adds a new node to the tree.

### Example

Let us consider how Prim's algorithm works in the following graph:

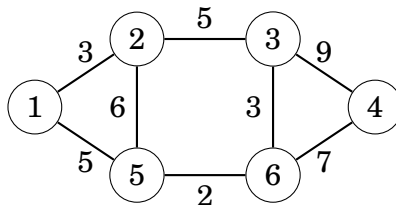

<sup>3</sup>The algorithm is named after R. C. Prim who published it in 1957 [55]. However, the same algorithm was discovered already in 1930 by V. Jarník.

Initially, there are no edges between the nodes:

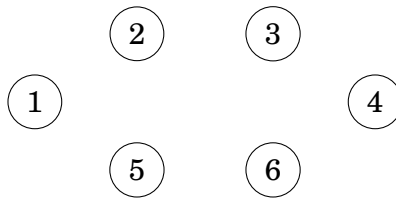

An arbitrary node can be the starting node, so let us choose node 1. First, we add node 2 that is connected by an edge of weight 3:

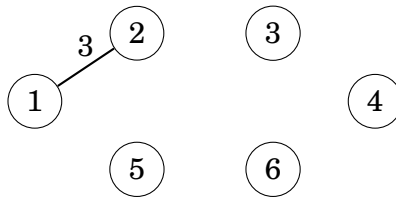

After this, there are two edges with weight 5, so we can add either node 3 or node 5 to the tree. Let us add node 3 first:

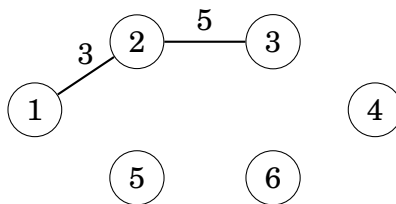

The process continues until all nodes have been included in the tree:

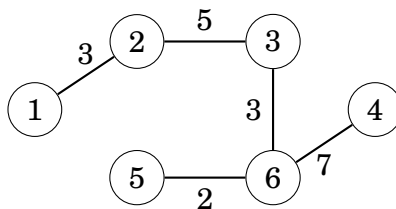

## Implementation

Like Dijkstra's algorithm, Prim's algorithm can be efficiently implemented using a priority queue. The priority queue should contain all nodes that can be connected to the current component using a single edge, in increasing order of the weights of the corresponding edges.

The time complexity of Prim's algorithm is  $O(n + m \log m)$  that equals the time complexity of Dijkstra's algorithm. In practice, Prim's and Kruskal's algorithms are both efficient, and the choice of the algorithm is a matter of taste. Still, most competitive programmers use Kruskal's algorithm.

# Chapter 16

## Directed graphs

In this chapter, we focus on two classes of directed graphs:

- **Acyclic graphs:** There are no cycles in the graph, so there is no path from any node to itself<sup>1</sup>.
- **Successor graphs:** The outdegree of each node is 1, so each node has a unique successor.

It turns out that in both cases, we can design efficient algorithms that are based on the special properties of the graphs.

### 16.1 Topological sorting

A **topological sort** is an ordering of the nodes of a directed graph such that if there is a path from node  $a$  to node  $b$ , then node  $a$  appears before node  $b$  in the ordering. For example, for the graph

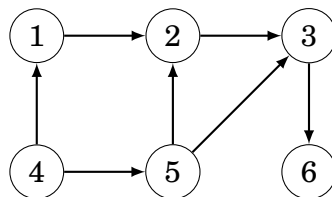

one topological sort is [4, 1, 5, 2, 3, 6]:

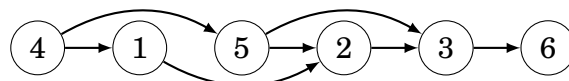

An acyclic graph always has a topological sort. However, if the graph contains a cycle, it is not possible to form a topological sort, because no node of the cycle can appear before the other nodes of the cycle in the ordering. It turns out that depth-first search can be used to both check if a directed graph contains a cycle and, if it does not contain a cycle, to construct a topological sort.

<sup>1</sup>Directed acyclic graphs are sometimes called DAGs.

## Algorithm

The idea is to go through the nodes of the graph and always begin a depth-first search at the current node if it has not been processed yet. During the searches, the nodes have three possible states:

- state 0: the node has not been processed (white)
- state 1: the node is under processing (light gray)
- state 2: the node has been processed (dark gray)

Initially, the state of each node is 0. When a search reaches a node for the first time, its state becomes 1. Finally, after all successors of the node have been processed, its state becomes 2.

If the graph contains a cycle, we will find this out during the search, because sooner or later we will arrive at a node whose state is 1. In this case, it is not possible to construct a topological sort.

If the graph does not contain a cycle, we can construct a topological sort by adding each node to a list when the state of the node becomes 2. This list in reverse order is a topological sort.

### Example 1

In the example graph, the search first proceeds from node 1 to node 6:

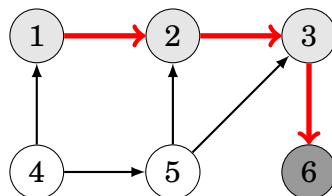

Now node 6 has been processed, so it is added to the list. After this, also nodes 3, 2 and 1 are added to the list:

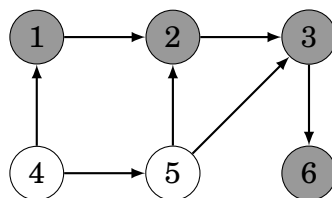

At this point, the list is [6,3,2,1]. The next search begins at node 4:

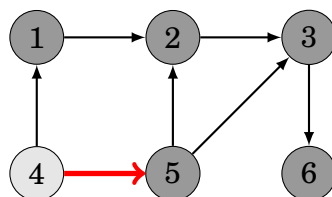



Thus, the final list is [6,3,2,1,5,4]. We have processed all nodes, so a topological sort has been found. The topological sort is the reverse list [4,5,1,2,3,6]:

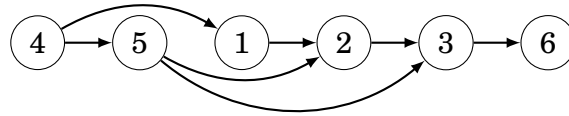

Note that a topological sort is not unique, and there can be several topological sorts for a graph.

## Example 2

Let us now consider a graph for which we cannot construct a topological sort, because the graph contains a cycle:

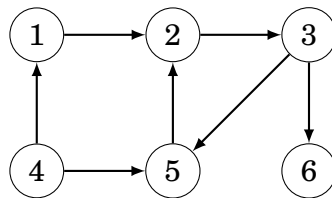

The search proceeds as follows:

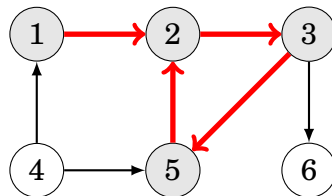

The search reaches node 2 whose state is 1, which means that the graph contains a cycle. In this example, there is a cycle  $2 \rightarrow 3 \rightarrow 5 \rightarrow 2$ .

## 16.2 Dynamic programming

If a directed graph is acyclic, dynamic programming can be applied to it. For example, we can efficiently solve the following problems concerning paths from a starting node to an ending node:

- how many different paths are there?
- what is the shortest/longest path?
- what is the minimum/maximum number of edges in a path?
- which nodes certainly appear in any path?

## Counting the number of paths

As an example, let us calculate the number of paths from node 1 to node 6 in the following graph:

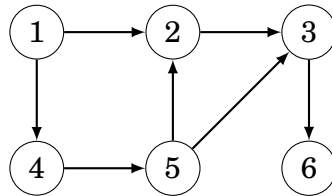

There are a total of three such paths:

- $1 \rightarrow 2 \rightarrow 3 \rightarrow 6$
- $1 \rightarrow 4 \rightarrow 5 \rightarrow 2 \rightarrow 3 \rightarrow 6$
- $1 \rightarrow 4 \rightarrow 5 \rightarrow 3 \rightarrow 6$

Let  $\text{paths}(x)$  denote the number of paths from node 1 to node  $x$ . As a base case,  $\text{paths}(1) = 1$ . Then, to calculate other values of  $\text{paths}(x)$ , we may use the recursion

$$\text{paths}(x) = \text{paths}(a_1) + \text{paths}(a_2) + \dots + \text{paths}(a_k)$$

where  $a_1, a_2, \dots, a_k$  are the nodes from which there is an edge to  $x$ . Since the graph is acyclic, the values of  $\text{paths}(x)$  can be calculated in the order of a topological sort. A topological sort for the above graph is as follows:

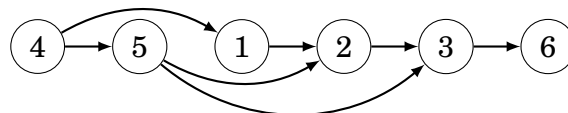

Hence, the numbers of paths are as follows:

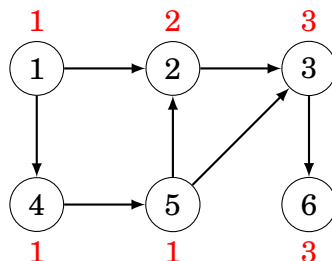

For example, to calculate the value of  $\text{paths}(3)$ , we can use the formula  $\text{paths}(2) + \text{paths}(5)$ , because there are edges from nodes 2 and 5 to node 3. Since  $\text{paths}(2) = 2$  and  $\text{paths}(5) = 1$ , we conclude that  $\text{paths}(3) = 3$ .

## Extending Dijkstra's algorithm

A by-product of Dijkstra's algorithm is a directed, acyclic graph that indicates for each node of the original graph the possible ways to reach the node using a shortest path from the starting node. Dynamic programming can be applied to that graph. For example, in the graph

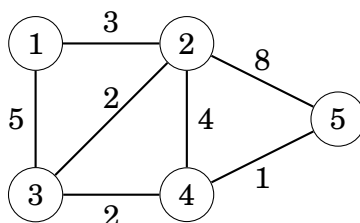

the shortest paths from node 1 may use the following edges:

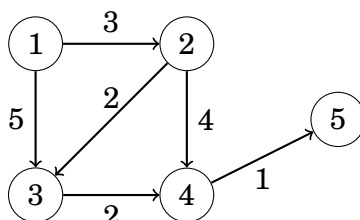

Now we can, for example, calculate the number of shortest paths from node 1 to node 5 using dynamic programming:

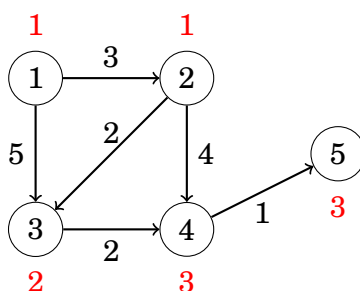

## Representing problems as graphs

Actually, any dynamic programming problem can be represented as a directed, acyclic graph. In such a graph, each node corresponds to a dynamic programming state and the edges indicate how the states depend on each other.

As an example, consider the problem of forming a sum of money  $n$  using coins  $\{c_1, c_2, \dots, c_k\}$ . In this problem, we can construct a graph where each node corresponds to a sum of money, and the edges show how the coins can be chosen. For example, for coins  $\{1, 3, 4\}$  and  $n = 6$ , the graph is as follows:

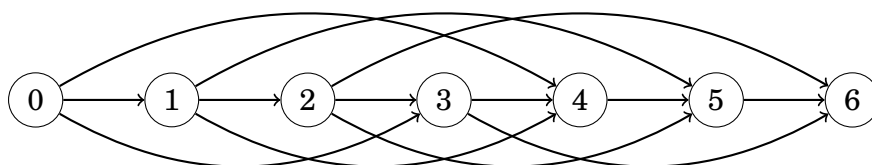

Using this representation, the shortest path from node 0 to node  $n$  corresponds to a solution with the minimum number of coins, and the total number of paths from node 0 to node  $n$  equals the total number of solutions.

## 16.3 Successor paths

For the rest of the chapter, we will focus on **successor graphs**. In those graphs, the outdegree of each node is 1, i.e., exactly one edge starts at each node. A successor graph consists of one or more components, each of which contains one cycle and some paths that lead to it.

Successor graphs are sometimes called **functional graphs**. The reason for this is that any successor graph corresponds to a function that defines the edges of the graph. The parameter for the function is a node of the graph, and the function gives the successor of that node.

For example, the function

|             |   |   |   |   |   |   |   |   |   |
|-------------|---|---|---|---|---|---|---|---|---|
| $x$         | 1 | 2 | 3 | 4 | 5 | 6 | 7 | 8 | 9 |
| succ( $x$ ) | 3 | 5 | 7 | 6 | 2 | 2 | 1 | 6 | 3 |

defines the following graph:

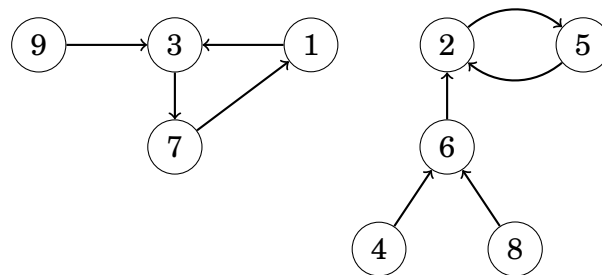

Since each node of a successor graph has a unique successor, we can also define a function  $\text{succ}(x, k)$  that gives the node that we will reach if we begin at node  $x$  and walk  $k$  steps forward. For example, in the above graph  $\text{succ}(4, 6) = 2$ , because we will reach node 2 by walking 6 steps from node 4:



A straightforward way to calculate a value of  $\text{succ}(x, k)$  is to start at node  $x$  and walk  $k$  steps forward, which takes  $O(k)$  time. However, using preprocessing, any value of  $\text{succ}(x, k)$  can be calculated in only  $O(\log k)$  time.

The idea is to precalculate all values of  $\text{succ}(x, k)$  where  $k$  is a power of two and at most  $u$ , where  $u$  is the maximum number of steps we will ever walk. This can be efficiently done, because we can use the following recursion:

$$\text{succ}(x, k) = \begin{cases} \text{succ}(x) & k = 1 \\ \text{succ}(\text{succ}(x, k/2), k/2) & k > 1 \end{cases}$$

Precalculating the values takes  $O(n \log u)$  time, because  $O(\log u)$  values are calculated for each node. In the above graph, the first values are as follows:

| $x$                 | 1 | 2 | 3 | 4 | 5 | 6 | 7 | 8 | 9 |
|---------------------|---|---|---|---|---|---|---|---|---|
| $\text{succ}(x, 1)$ | 3 | 5 | 7 | 6 | 2 | 2 | 1 | 6 | 3 |
| $\text{succ}(x, 2)$ | 7 | 2 | 1 | 2 | 5 | 5 | 3 | 2 | 7 |
| $\text{succ}(x, 4)$ | 3 | 2 | 7 | 2 | 5 | 5 | 1 | 2 | 3 |
| $\text{succ}(x, 8)$ | 7 | 2 | 1 | 2 | 5 | 5 | 3 | 2 | 7 |
| ...                 |   |   |   |   |   |   |   |   |   |

After this, any value of  $\text{succ}(x, k)$  can be calculated by presenting the number of steps  $k$  as a sum of powers of two. For example, if we want to calculate the value of  $\text{succ}(x, 11)$ , we first form the representation  $11 = 8 + 2 + 1$ . Using that,

$$\text{succ}(x, 11) = \text{succ}(\text{succ}(\text{succ}(x, 8), 2), 1).$$

For example, in the previous graph

$$\text{succ}(4, 11) = \text{succ}(\text{succ}(\text{succ}(4, 8), 2), 1) = 5.$$

Such a representation always consists of  $O(\log k)$  parts, so calculating a value of  $\text{succ}(x, k)$  takes  $O(\log k)$  time.

## 16.4 Cycle detection

Consider a successor graph that only contains a path that ends in a cycle. We may ask the following questions: if we begin our walk at the starting node, what is the first node in the cycle and how many nodes does the cycle contain?

For example, in the graph

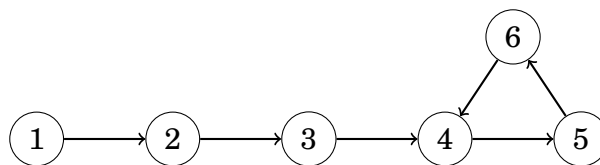

we begin our walk at node 1, the first node that belongs to the cycle is node 4, and the cycle consists of three nodes (4, 5 and 6).

A simple way to detect the cycle is to walk in the graph and keep track of all nodes that have been visited. Once a node is visited for the second time, we can conclude that the node is the first node in the cycle. This method works in  $O(n)$  time and also uses  $O(n)$  memory.

However, there are better algorithms for cycle detection. The time complexity of such algorithms is still  $O(n)$ , but they only use  $O(1)$  memory. This is an important improvement if  $n$  is large. Next we will discuss Floyd's algorithm that achieves these properties.

### Floyd's algorithm

**Floyd's algorithm**<sup>2</sup> walks forward in the graph using two pointers  $a$  and  $b$ . Both pointers begin at a node  $x$  that is the starting node of the graph. Then,

<sup>2</sup>The idea of the algorithm is mentioned in [46] and attributed to R. W. Floyd; however, it is not known if Floyd actually discovered the algorithm.

on each turn, the pointer  $a$  walks one step forward and the pointer  $b$  walks two steps forward. The process continues until the pointers meet each other:

```
a = succ(x);
b = succ(succ(x));
while (a != b) {
    a = succ(a);
    b = succ(succ(b));
}
```

At this point, the pointer  $a$  has walked  $k$  steps and the pointer  $b$  has walked  $2k$  steps, so the length of the cycle divides  $k$ . Thus, the first node that belongs to the cycle can be found by moving the pointer  $a$  to node  $x$  and advancing the pointers step by step until they meet again.

```
a = x;
while (a != b) {
    a = succ(a);
    b = succ(b);
}
first = a;
```

After this, the length of the cycle can be calculated as follows:

```
b = succ(a);
length = 1;
while (a != b) {
    b = succ(b);
    length++;
}
```

# Chapter 17

## Strong connectivity

In a directed graph, the edges can be traversed in one direction only, so even if the graph is connected, this does not guarantee that there would be a path from a node to another node. For this reason, it is meaningful to define a new concept that requires more than connectivity.

A graph is **strongly connected** if there is a path from any node to all other nodes in the graph. For example, in the following picture, the left graph is strongly connected while the right graph is not.

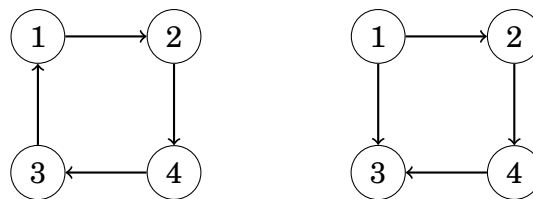

The right graph is not strongly connected because, for example, there is no path from node 2 to node 1.

The **strongly connected components** of a graph divide the graph into strongly connected parts that are as large as possible. The strongly connected components form an acyclic **component graph** that represents the deep structure of the original graph.

For example, for the graph

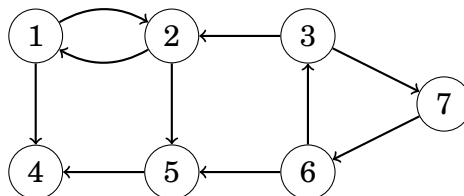

the strongly connected components are as follows:

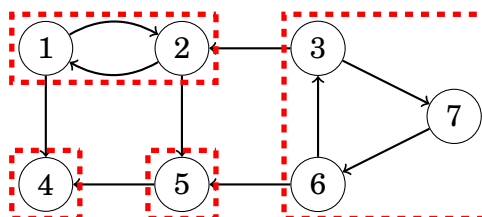

The corresponding component graph is as follows:

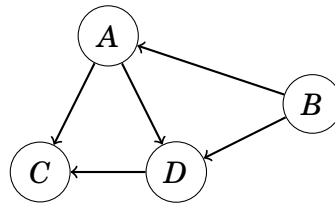

The components are  $A = \{1, 2\}$ ,  $B = \{3, 6, 7\}$ ,  $C = \{4\}$  and  $D = \{5\}$ .

A component graph is an acyclic, directed graph, so it is easier to process than the original graph. Since the graph does not contain cycles, we can always construct a topological sort and use dynamic programming techniques like those presented in Chapter 16.

## 17.1 Kosaraju's algorithm

**Kosaraju's algorithm**<sup>1</sup> is an efficient method for finding the strongly connected components of a directed graph. The algorithm performs two depth-first searches: the first search constructs a list of nodes according to the structure of the graph, and the second search forms the strongly connected components.

### Search 1

The first phase of Kosaraju's algorithm constructs a list of nodes in the order in which a depth-first search processes them. The algorithm goes through the nodes, and begins a depth-first search at each unprocessed node. Each node will be added to the list after it has been processed.

In the example graph, the nodes are processed in the following order:

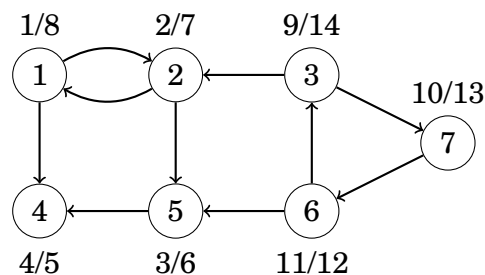

The notation  $x/y$  means that processing the node started at time  $x$  and finished at time  $y$ . Thus, the corresponding list is as follows:

<sup>1</sup>According to [1], S. R. Kosaraju invented this algorithm in 1978 but did not publish it. In 1981, the same algorithm was rediscovered and published by M. Sharir [58].



| node | processing time |
|------|-----------------|
| 4    | 5               |
| 5    | 6               |
| 2    | 7               |
| 1    | 8               |
| 6    | 12              |
| 7    | 13              |
| 3    | 14              |

## Search 2

The second phase of the algorithm forms the strongly connected components of the graph. First, the algorithm reverses every edge in the graph. This guarantees that during the second search, we will always find strongly connected components that do not have extra nodes.

After reversing the edges, the example graph is as follows:

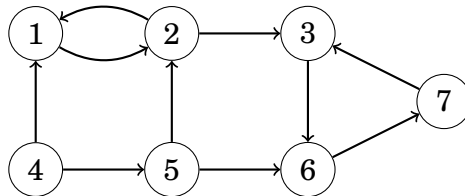

After this, the algorithm goes through the list of nodes created by the first search, in *reverse* order. If a node does not belong to a component, the algorithm creates a new component and starts a depth-first search that adds all new nodes found during the search to the new component.

In the example graph, the first component begins at node 3:

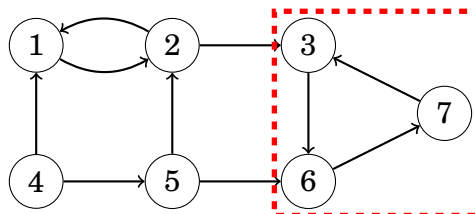

Note that since all edges are reversed, the component does not "leak" to other parts in the graph.

The next nodes in the list are nodes 7 and 6, but they already belong to a component, so the next new component begins at node 1:

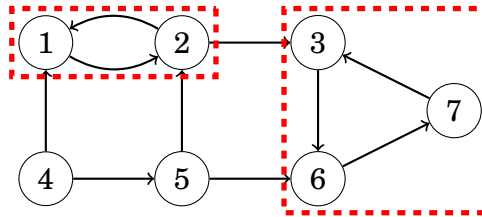

Finally, the algorithm processes nodes 5 and 4 that create the remaining strongly connected components:

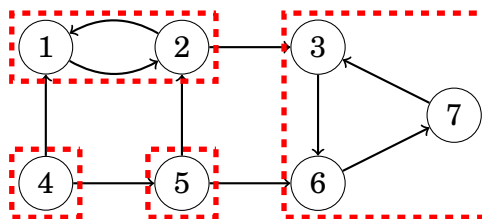

The time complexity of the algorithm is  $O(n + m)$ , because the algorithm performs two depth-first searches.

## 17.2 2SAT problem

Strong connectivity is also linked with the **2SAT problem**<sup>2</sup>. In this problem, we are given a logical formula

$$(a_1 \vee b_1) \wedge (a_2 \vee b_2) \wedge \cdots \wedge (a_m \vee b_m),$$

where each  $a_i$  and  $b_i$  is either a logical variable ( $x_1, x_2, \dots, x_n$ ) or a negation of a logical variable ( $\neg x_1, \neg x_2, \dots, \neg x_n$ ). The symbols " $\wedge$ " and " $\vee$ " denote logical operators "and" and "or". Our task is to assign each variable a value so that the formula is true, or state that this is not possible.

For example, the formula

$$L_1 = (x_2 \vee \neg x_1) \wedge (\neg x_1 \vee \neg x_2) \wedge (x_1 \vee x_3) \wedge (\neg x_2 \vee \neg x_3) \wedge (x_1 \vee x_4)$$

is true when the variables are assigned as follows:

$$\begin{cases} x_1 = \text{false} \\ x_2 = \text{false} \\ x_3 = \text{true} \\ x_4 = \text{true} \end{cases}$$

<sup>2</sup>The algorithm presented here was introduced in [4]. There is also another well-known linear-time algorithm [19] that is based on backtracking.

However, the formula

$$L_2 = (x_1 \vee x_2) \wedge (x_1 \vee \neg x_2) \wedge (\neg x_1 \vee x_3) \wedge (\neg x_1 \vee \neg x_3)$$

is always false, regardless of how we assign the values. The reason for this is that we cannot choose a value for  $x_1$  without creating a contradiction. If  $x_1$  is false, both  $x_2$  and  $\neg x_2$  should be true which is impossible, and if  $x_1$  is true, both  $x_3$  and  $\neg x_3$  should be true which is also impossible.

The 2SAT problem can be represented as a graph whose nodes correspond to variables  $x_i$  and negations  $\neg x_i$ , and edges determine the connections between the variables. Each pair  $(a_i \vee b_i)$  generates two edges:  $\neg a_i \rightarrow b_i$  and  $\neg b_i \rightarrow a_i$ . This means that if  $a_i$  does not hold,  $b_i$  must hold, and vice versa.

The graph for the formula  $L_1$  is:

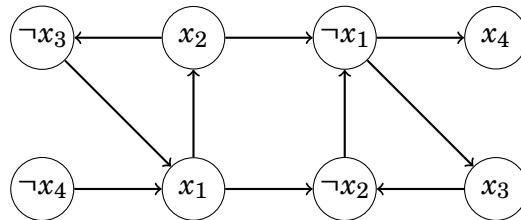

And the graph for the formula  $L_2$  is:

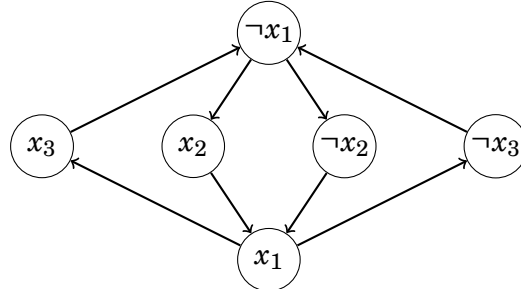

The structure of the graph tells us whether it is possible to assign the values of the variables so that the formula is true. It turns out that this can be done exactly when there are no nodes  $x_i$  and  $\neg x_i$  such that both nodes belong to the same strongly connected component. If there are such nodes, the graph contains a path from  $x_i$  to  $\neg x_i$  and also a path from  $\neg x_i$  to  $x_i$ , so both  $x_i$  and  $\neg x_i$  should be true which is not possible.

In the graph of the formula  $L_1$  there are no nodes  $x_i$  and  $\neg x_i$  such that both nodes belong to the same strongly connected component, so a solution exists. In the graph of the formula  $L_2$  all nodes belong to the same strongly connected component, so a solution does not exist.

If a solution exists, the values for the variables can be found by going through the nodes of the component graph in a reverse topological sort order. At each step, we process a component that does not contain edges that lead to an unprocessed component. If the variables in the component have not been assigned values, their values will be determined according to the values in the component, and if

they already have values, they remain unchanged. The process continues until each variable has been assigned a value.

The component graph for the formula  $L_1$  is as follows:

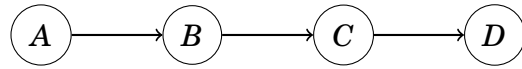

The components are  $A = \{\neg x_4\}$ ,  $B = \{x_1, x_2, \neg x_3\}$ ,  $C = \{\neg x_1, \neg x_2, x_3\}$  and  $D = \{x_4\}$ . When constructing the solution, we first process the component  $D$  where  $x_4$  becomes true. After this, we process the component  $C$  where  $x_1$  and  $x_2$  become false and  $x_3$  becomes true. All variables have been assigned values, so the remaining components  $A$  and  $B$  do not change the variables.

Note that this method works, because the graph has a special structure: if there are paths from node  $x_i$  to node  $x_j$  and from node  $x_j$  to node  $\neg x_j$ , then node  $x_i$  never becomes true. The reason for this is that there is also a path from node  $\neg x_j$  to node  $\neg x_i$ , and both  $x_i$  and  $x_j$  become false.

A more difficult problem is the **3SAT problem**, where each part of the formula is of the form  $(a_i \vee b_i \vee c_i)$ . This problem is NP-hard, so no efficient algorithm for solving the problem is known.

# Chapter 18

## Tree queries

This chapter discusses techniques for processing queries on subtrees and paths of a rooted tree. For example, such queries are:

- what is the  $k$ th ancestor of a node?
- what is the sum of values in the subtree of a node?
- what is the sum of values on a path between two nodes?
- what is the lowest common ancestor of two nodes?

### 18.1 Finding ancestors

The  $k$ th **ancestor** of a node  $x$  in a rooted tree is the node that we will reach if we move  $k$  levels up from  $x$ . Let  $\text{ancestor}(x, k)$  denote the  $k$ th ancestor of a node  $x$  (or 0 if there is no such an ancestor). For example, in the following tree,  $\text{ancestor}(2, 1) = 1$  and  $\text{ancestor}(8, 2) = 4$ .

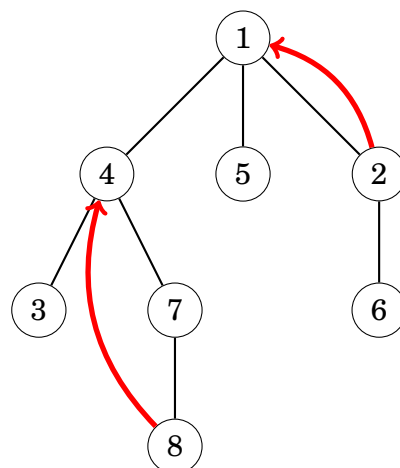

An easy way to calculate any value of  $\text{ancestor}(x, k)$  is to perform a sequence of  $k$  moves in the tree. However, the time complexity of this method is  $O(k)$ , which may be slow, because a tree of  $n$  nodes may have a chain of  $n$  nodes.

Fortunately, using a technique similar to that used in Chapter 16.3, any value of  $\text{ancestor}(x, k)$  can be efficiently calculated in  $O(\log k)$  time after preprocessing. The idea is to precalculate all values  $\text{ancestor}(x, k)$  where  $k \leq n$  is a power of two. For example, the values for the above tree are as follows:

| $x$                     | 1 | 2 | 3 | 4 | 5 | 6 | 7 | 8 |
|-------------------------|---|---|---|---|---|---|---|---|
| $\text{ancestor}(x, 1)$ | 0 | 1 | 4 | 1 | 1 | 2 | 4 | 7 |
| $\text{ancestor}(x, 2)$ | 0 | 0 | 1 | 0 | 0 | 1 | 1 | 4 |
| $\text{ancestor}(x, 4)$ | 0 | 0 | 0 | 0 | 0 | 0 | 0 | 0 |
| ...                     |   |   |   |   |   |   |   |   |

The preprocessing takes  $O(n \log n)$  time, because  $O(\log n)$  values are calculated for each node. After this, any value of  $\text{ancestor}(x, k)$  can be calculated in  $O(\log k)$  time by representing  $k$  as a sum where each term is a power of two.

## 18.2 Subtrees and paths

A **tree traversal array** contains the nodes of a rooted tree in the order in which a depth-first search from the root node visits them. For example, in the tree

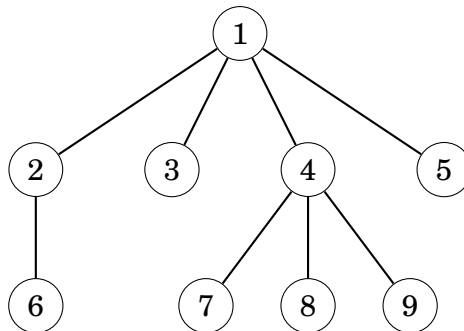

a depth-first search proceeds as follows:

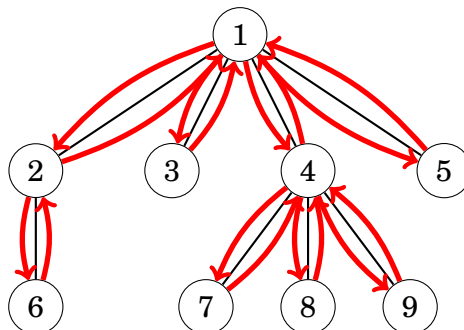

Hence, the corresponding tree traversal array is as follows:

|   |   |   |   |   |   |   |   |   |
|---|---|---|---|---|---|---|---|---|
| 1 | 2 | 6 | 3 | 4 | 7 | 8 | 9 | 5 |
|---|---|---|---|---|---|---|---|---|

## Subtree queries

Each subtree of a tree corresponds to a subarray of the tree traversal array such that the first element of the subarray is the root node. For example, the following subarray contains the nodes of the subtree of node 4:

|   |   |   |   |   |   |   |   |   |
|---|---|---|---|---|---|---|---|---|
| 1 | 2 | 6 | 3 | 4 | 7 | 8 | 9 | 5 |
|---|---|---|---|---|---|---|---|---|

Using this fact, we can efficiently process queries that are related to subtrees of a tree. As an example, consider a problem where each node is assigned a value, and our task is to support the following queries:

- update the value of a node
- calculate the sum of values in the subtree of a node

Consider the following tree where the blue numbers are the values of the nodes. For example, the sum of the subtree of node 4 is  $3 + 4 + 3 + 1 = 11$ .

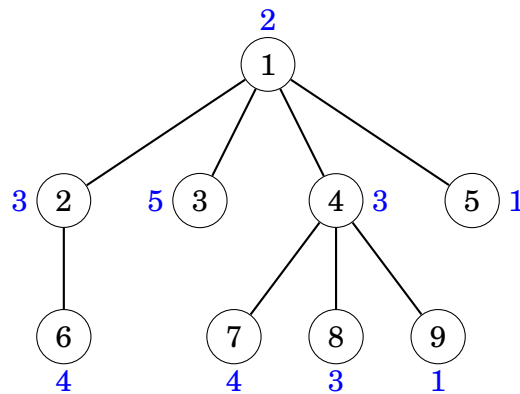

The idea is to construct a tree traversal array that contains three values for each node: the identifier of the node, the size of the subtree, and the value of the node. For example, the array for the above tree is as follows:

|              |   |   |   |   |   |   |   |   |   |
|--------------|---|---|---|---|---|---|---|---|---|
| node id      | 1 | 2 | 6 | 3 | 4 | 7 | 8 | 9 | 5 |
| subtree size | 9 | 2 | 1 | 1 | 4 | 1 | 1 | 1 | 1 |
| node value   | 2 | 3 | 4 | 5 | 3 | 4 | 3 | 1 | 1 |

Using this array, we can calculate the sum of values in any subtree by first finding out the size of the subtree and then the values of the corresponding nodes. For example, the values in the subtree of node 4 can be found as follows:

|              |   |   |   |   |   |   |   |   |   |
|--------------|---|---|---|---|---|---|---|---|---|
| node id      | 1 | 2 | 6 | 3 | 4 | 7 | 8 | 9 | 5 |
| subtree size | 9 | 2 | 1 | 1 | 4 | 1 | 1 | 1 | 1 |
| node value   | 2 | 3 | 4 | 5 | 3 | 4 | 3 | 1 | 1 |

To answer the queries efficiently, it suffices to store the values of the nodes in a binary indexed or segment tree. After this, we can both update a value and calculate the sum of values in  $O(\log n)$  time.

## Path queries

Using a tree traversal array, we can also efficiently calculate sums of values on paths from the root node to any node of the tree. Consider a problem where our task is to support the following queries:

- change the value of a node
- calculate the sum of values on a path from the root to a node

For example, in the following tree, the sum of values from the root node to node 7 is  $4 + 5 + 5 = 14$ :

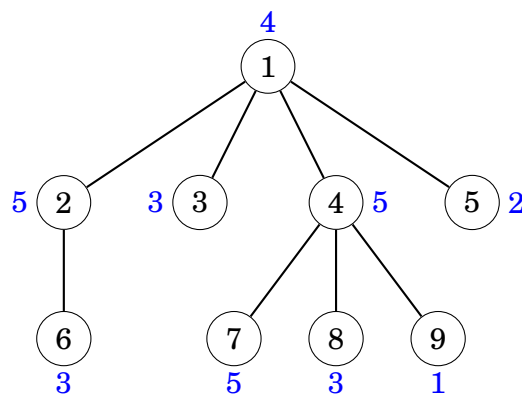

We can solve this problem like before, but now each value in the last row of the array is the sum of values on a path from the root to the node. For example, the following array corresponds to the above tree:

|              |   |   |    |   |   |    |    |    |   |
|--------------|---|---|----|---|---|----|----|----|---|
| node id      | 1 | 2 | 6  | 3 | 4 | 7  | 8  | 9  | 5 |
| subtree size | 9 | 2 | 1  | 1 | 4 | 1  | 1  | 1  | 1 |
| path sum     | 4 | 9 | 12 | 7 | 9 | 14 | 12 | 10 | 6 |

When the value of a node increases by  $x$ , the sums of all nodes in its subtree increase by  $x$ . For example, if the value of node 4 increases by 1, the array changes as follows:

|              |   |   |    |   |    |    |    |    |   |
|--------------|---|---|----|---|----|----|----|----|---|
| node id      | 1 | 2 | 6  | 3 | 4  | 7  | 8  | 9  | 5 |
| subtree size | 9 | 2 | 1  | 1 | 4  | 1  | 1  | 1  | 1 |
| path sum     | 4 | 9 | 12 | 7 | 10 | 15 | 13 | 11 | 6 |

Thus, to support both the operations, we should be able to increase all values in a range and retrieve a single value. This can be done in  $O(\log n)$  time using a binary indexed or segment tree (see Chapter 9.4).



## 18.3 Lowest common ancestor

The **lowest common ancestor** of two nodes of a rooted tree is the lowest node whose subtree contains both the nodes. A typical problem is to efficiently process queries that ask to find the lowest common ancestor of two nodes.

For example, in the following tree, the lowest common ancestor of nodes 5 and 8 is node 2:

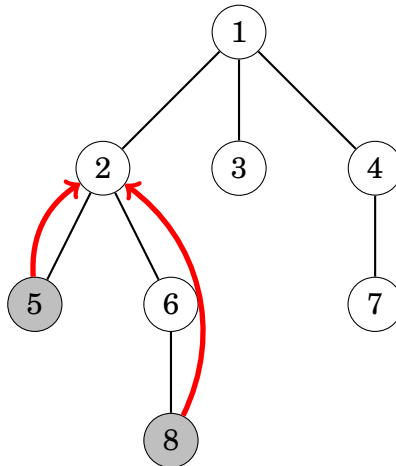

Next we will discuss two efficient techniques for finding the lowest common ancestor of two nodes.

### Method 1

One way to solve the problem is to use the fact that we can efficiently find the  $k$ th ancestor of any node in the tree. Using this, we can divide the problem of finding the lowest common ancestor into two parts.

We use two pointers that initially point to the two nodes whose lowest common ancestor we should find. First, we move one of the pointers upwards so that both pointers point to nodes at the same level.

In the example scenario, we move the second pointer one level up so that it points to node 6 which is at the same level with node 5:

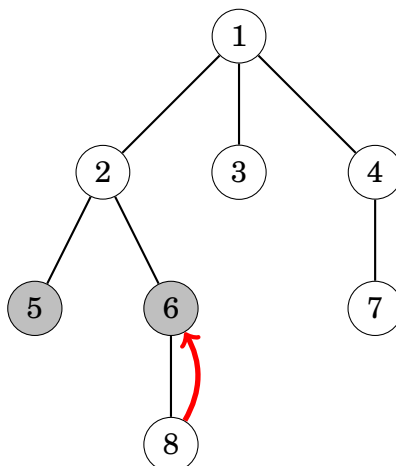

After this, we determine the minimum number of steps needed to move both pointers upwards so that they will point to the same node. The node to which the pointers point after this is the lowest common ancestor.

In the example scenario, it suffices to move both pointers one step upwards to node 2, which is the lowest common ancestor:

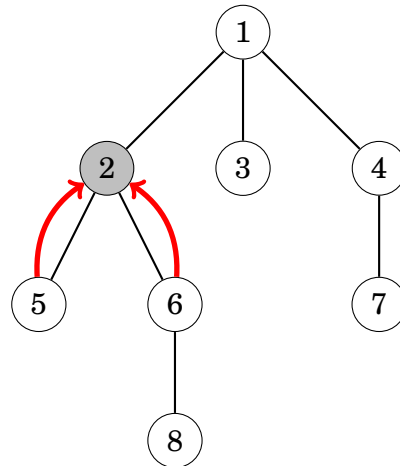

Since both parts of the algorithm can be performed in  $O(\log n)$  time using precomputed information, we can find the lowest common ancestor of any two nodes in  $O(\log n)$  time.

## Method 2

Another way to solve the problem is based on a tree traversal array<sup>1</sup>. Once again, the idea is to traverse the nodes using a depth-first search:

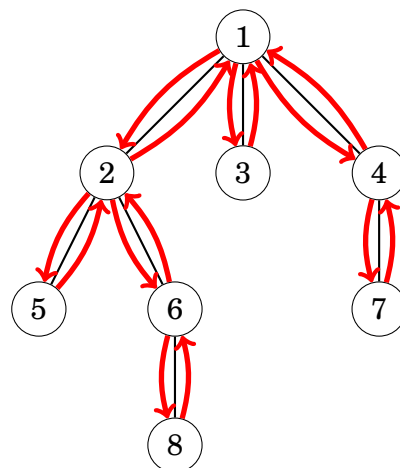

However, we use a different tree traversal array than before: we add each node to the array *always* when the depth-first search walks through the node, and not only at the first visit. Hence, a node that has  $k$  children appears  $k + 1$  times in the array and there are a total of  $2n - 1$  nodes in the array.

<sup>1</sup>This lowest common ancestor algorithm was presented in [7]. This technique is sometimes called the **Euler tour technique** [66].

We store two values in the array: the identifier of the node and the depth of the node in the tree. The following array corresponds to the above tree:

|         | 0 | 1 | 2 | 3 | 4 | 5 | 6 | 7 | 8 | 9 | 10 | 11 | 12 | 13 | 14 |
|---------|---|---|---|---|---|---|---|---|---|---|----|----|----|----|----|
| node id | 1 | 2 | 5 | 2 | 6 | 8 | 6 | 2 | 1 | 3 | 1  | 4  | 7  | 4  | 1  |
| depth   | 1 | 2 | 3 | 2 | 3 | 4 | 3 | 2 | 1 | 2 | 1  | 2  | 3  | 2  | 1  |

Now we can find the lowest common ancestor of nodes  $a$  and  $b$  by finding the node with the *minimum* depth between nodes  $a$  and  $b$  in the array. For example, the lowest common ancestor of nodes 5 and 8 can be found as follows:

|         | 0 | 1 | 2 | 3 | 4 | 5 | 6 | 7 | 8 | 9 | 10 | 11 | 12 | 13 | 14 |
|---------|---|---|---|---|---|---|---|---|---|---|----|----|----|----|----|
| node id | 1 | 2 | 5 | 2 | 6 | 8 | 6 | 2 | 1 | 3 | 1  | 4  | 7  | 4  | 1  |
| depth   | 1 | 2 | 3 | 2 | 3 | 4 | 3 | 2 | 1 | 2 | 1  | 2  | 3  | 2  | 1  |

↑

Node 5 is at position 2, node 8 is at position 5, and the node with minimum depth between positions 2...5 is node 2 at position 3 whose depth is 2. Thus, the lowest common ancestor of nodes 5 and 8 is node 2.

Thus, to find the lowest common ancestor of two nodes it suffices to process a range minimum query. Since the array is static, we can process such queries in  $O(1)$  time after an  $O(n \log n)$  time preprocessing.

## Distances of nodes

The distance between nodes  $a$  and  $b$  equals the length of the path from  $a$  to  $b$ . It turns out that the problem of calculating the distance between nodes reduces to finding their lowest common ancestor.

First, we root the tree arbitrarily. After this, the distance of nodes  $a$  and  $b$  can be calculated using the formula

$$\text{depth}(a) + \text{depth}(b) - 2 \cdot \text{depth}(c),$$

where  $c$  is the lowest common ancestor of  $a$  and  $b$  and  $\text{depth}(s)$  denotes the depth of node  $s$ . For example, consider the distance of nodes 5 and 8:

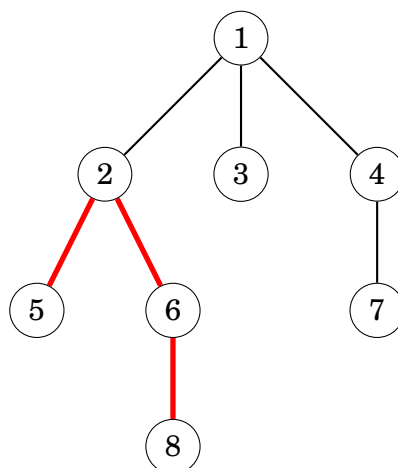

The lowest common ancestor of nodes 5 and 8 is node 2. The depths of the nodes are  $\text{depth}(5) = 3$ ,  $\text{depth}(8) = 4$  and  $\text{depth}(2) = 2$ , so the distance between nodes 5 and 8 is  $3 + 4 - 2 \cdot 2 = 3$ .

## 18.4 Offline algorithms

So far, we have discussed *online* algorithms for tree queries. Those algorithms are able to process queries one after another so that each query is answered before receiving the next query.

However, in many problems, the online property is not necessary. In this section, we focus on *offline* algorithms. Those algorithms are given a set of queries which can be answered in any order. It is often easier to design an offline algorithm compared to an online algorithm.

### Merging data structures

One method to construct an offline algorithm is to perform a depth-first tree traversal and maintain data structures in nodes. At each node  $s$ , we create a data structure  $d[s]$  that is based on the data structures of the children of  $s$ . Then, using this data structure, all queries related to  $s$  are processed.

As an example, consider the following problem: We are given a tree where each node has some value. Our task is to process queries of the form "calculate the number of nodes with value  $x$  in the subtree of node  $s$ ". For example, in the following tree, the subtree of node 4 contains two nodes whose value is 3.

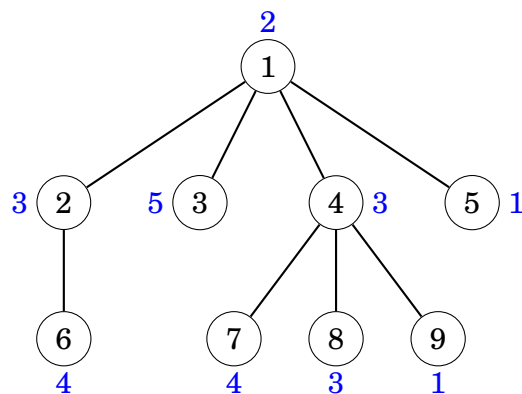

In this problem, we can use map structures to answer the queries. For example, the maps for node 4 and its children are as follows:

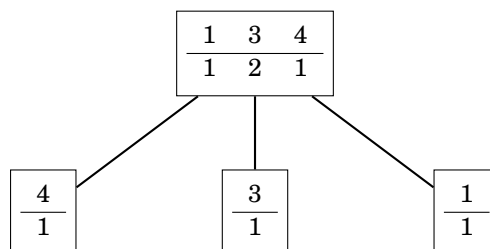

If we create such a data structure for each node, we can easily process all given queries, because we can handle all queries related to a node immediately after creating its data structure. For example, the above map structure for node 4 tells us that its subtree contains two nodes whose value is 3.

However, it would be too slow to create all data structures from scratch. Instead, at each node  $s$ , we create an initial data structure  $d[s]$  that only contains the value of  $s$ . After this, we go through the children of  $s$  and *merge*  $d[s]$  and all data structures  $d[u]$  where  $u$  is a child of  $s$ .

For example, in the above tree, the map for node 4 is created by merging the following maps:

$$\boxed{\frac{3}{1}} \quad \boxed{\frac{4}{1}} \quad \boxed{\frac{3}{1}} \quad \boxed{\frac{1}{1}}$$

Here the first map is the initial data structure for node 4, and the other three maps correspond to nodes 7, 8 and 9.

The merging at node  $s$  can be done as follows: We go through the children of  $s$  and at each child  $u$  merge  $d[s]$  and  $d[u]$ . We always copy the contents from  $d[u]$  to  $d[s]$ . However, before this, we *swap* the contents of  $d[s]$  and  $d[u]$  if  $d[s]$  is smaller than  $d[u]$ . By doing this, each value is copied only  $O(\log n)$  times during the tree traversal, which ensures that the algorithm is efficient.

To swap the contents of two data structures  $a$  and  $b$  efficiently, we can just use the following code:

```
swap(a, b);
```

It is guaranteed that the above code works in constant time when  $a$  and  $b$  are C++ standard library data structures.

## Lowest common ancestors

There is also an offline algorithm for processing a set of lowest common ancestor queries<sup>2</sup>. The algorithm is based on the union-find data structure (see Chapter 15.2), and the benefit of the algorithm is that it is easier to implement than the algorithms discussed earlier in this chapter.

The algorithm is given as input a set of pairs of nodes, and it determines for each such pair the lowest common ancestor of the nodes. The algorithm performs a depth-first tree traversal and maintains disjoint sets of nodes. Initially, each node belongs to a separate set. For each set, we also store the highest node in the tree that belongs to the set.

When the algorithm visits a node  $x$ , it goes through all nodes  $y$  such that the lowest common ancestor of  $x$  and  $y$  has to be found. If  $y$  has already been visited, the algorithm reports that the lowest common ancestor of  $x$  and  $y$  is the highest node in the set of  $y$ . Then, after processing node  $x$ , the algorithm joins the sets of  $x$  and its parent.

<sup>2</sup>This algorithm was published by R. E. Tarjan in 1979 [65].

For example, suppose that we want to find the lowest common ancestors of node pairs (5,8) and (2,7) in the following tree:

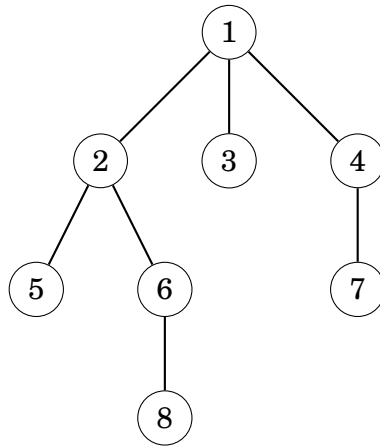

In the following trees, gray nodes denote visited nodes and dashed groups of nodes belong to the same set. When the algorithm visits node 8, it notices that node 5 has been visited and the highest node in its set is 2. Thus, the lowest common ancestor of nodes 5 and 8 is 2:

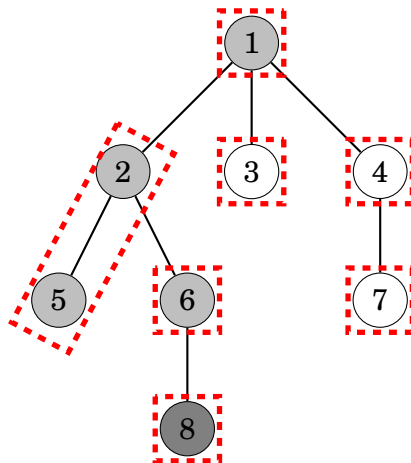

Later, when visiting node 7, the algorithm determines that the lowest common ancestor of nodes 2 and 7 is 1:

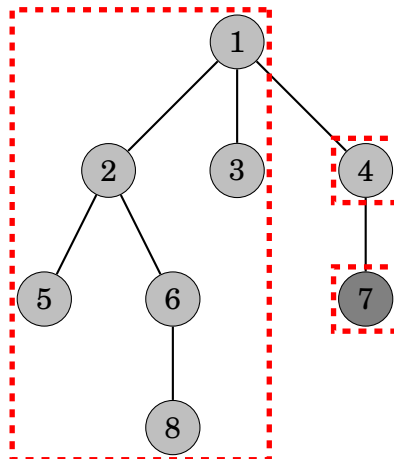

# Chapter 19

## Paths and circuits

This chapter focuses on two types of paths in graphs:

- An **Eulerian path** is a path that goes through each edge exactly once.
- A **Hamiltonian path** is a path that visits each node exactly once.

While Eulerian and Hamiltonian paths look like similar concepts at first glance, the computational problems related to them are very different. It turns out that there is a simple rule that determines whether a graph contains an Eulerian path, and there is also an efficient algorithm to find such a path if it exists. On the contrary, checking the existence of a Hamiltonian path is a NP-hard problem, and no efficient algorithm is known for solving the problem.

### 19.1 Eulerian paths

An **Eulerian path**<sup>1</sup> is a path that goes exactly once through each edge of the graph. For example, the graph

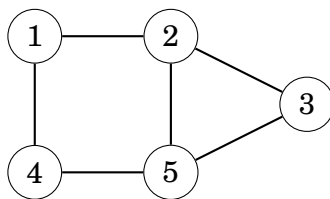

has an Eulerian path from node 2 to node 5:

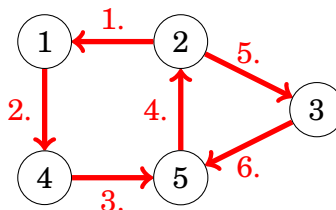

---

<sup>1</sup>L. Euler studied such paths in 1736 when he solved the famous Königsberg bridge problem. This was the birth of graph theory.

An **Eulerian circuit** is an Eulerian path that starts and ends at the same node. For example, the graph

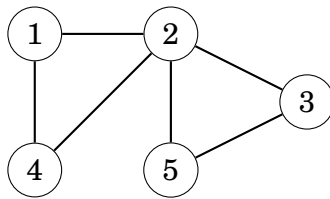

has an Eulerian circuit that starts and ends at node 1:

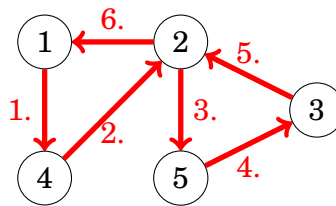

## Existence

The existence of Eulerian paths and circuits depends on the degrees of the nodes. First, an undirected graph has an Eulerian path exactly when all the edges belong to the same connected component and

- the degree of each node is even *or*
- the degree of exactly two nodes is odd, and the degree of all other nodes is even.

In the first case, each Eulerian path is also an Eulerian circuit. In the second case, the odd-degree nodes are the starting and ending nodes of an Eulerian path which is not an Eulerian circuit.

For example, in the graph

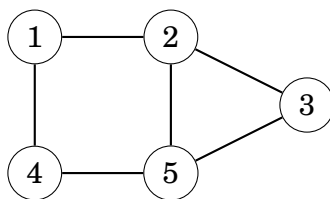

nodes 1, 3 and 4 have a degree of 2, and nodes 2 and 5 have a degree of 3. Exactly two nodes have an odd degree, so there is an Eulerian path between nodes 2 and 5, but the graph does not contain an Eulerian circuit.

In a directed graph, we focus on indegrees and outdegrees of the nodes. A directed graph contains an Eulerian path exactly when all the edges belong to the same strongly connected component and

- in each node, the indegree equals the outdegree, *or*



- in one node, the indegree is one larger than the outdegree, in another node, the outdegree is one larger than the indegree, and in all other nodes, the indegree equals the outdegree.

In the first case, each Eulerian path is also an Eulerian circuit, and in the second case, the graph contains an Eulerian path that begins at the node whose outdegree is larger and ends at the node whose indegree is larger.

For example, in the graph

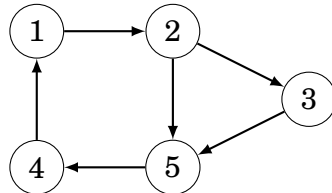

nodes 1, 3 and 4 have both indegree 1 and outdegree 1, node 2 has indegree 1 and outdegree 2, and node 5 has indegree 2 and outdegree 1. Hence, the graph contains an Eulerian path from node 2 to node 5:

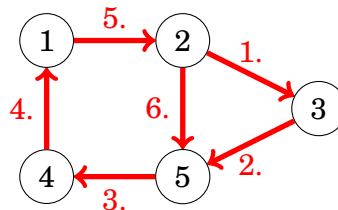

## Hierholzer's algorithm

**Hierholzer's algorithm**<sup>2</sup> is an efficient method for constructing an Eulerian circuit. The algorithm consists of several rounds, each of which adds new edges to the circuit. Of course, we assume that the graph contains an Eulerian circuit; otherwise Hierholzer's algorithm cannot find it.

First, the algorithm constructs a circuit that contains some (not necessarily all) of the edges of the graph. After this, the algorithm extends the circuit step by step by adding subcircuits to it. The process continues until all edges have been added to the circuit.

The algorithm extends the circuit by always finding a node  $x$  that belongs to the circuit but has an outgoing edge that is not included in the circuit. The algorithm constructs a new path from node  $x$  that only contains edges that are not yet in the circuit. Sooner or later, the path will return to node  $x$ , which creates a subcircuit.

If the graph only contains an Eulerian path, we can still use Hierholzer's algorithm to find it by adding an extra edge to the graph and removing the edge after the circuit has been constructed. For example, in an undirected graph, we add the extra edge between the two odd-degree nodes.

Next we will see how Hierholzer's algorithm constructs an Eulerian circuit for an undirected graph.

<sup>2</sup>The algorithm was published in 1873 after Hierholzer's death [35].

## Example

Let us consider the following graph:

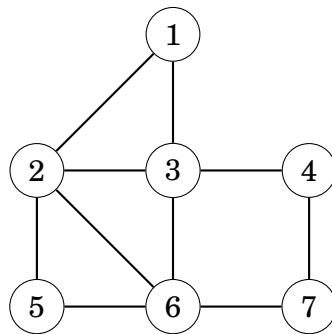

Suppose that the algorithm first creates a circuit that begins at node 1. A possible circuit is  $1 \rightarrow 2 \rightarrow 3 \rightarrow 1$ :

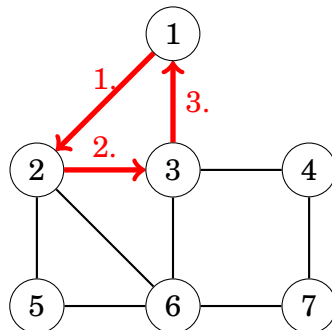

After this, the algorithm adds the subcircuit  $2 \rightarrow 5 \rightarrow 6 \rightarrow 2$  to the circuit:

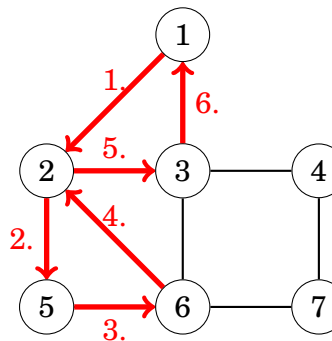

Finally, the algorithm adds the subcircuit  $6 \rightarrow 3 \rightarrow 4 \rightarrow 7 \rightarrow 6$  to the circuit:

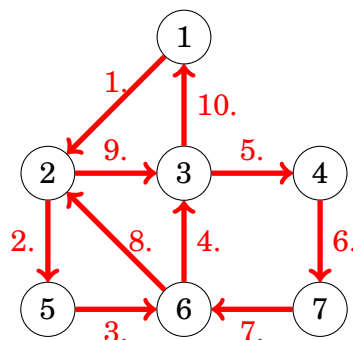

Now all edges are included in the circuit, so we have successfully constructed an Eulerian circuit.

## 19.2 Hamiltonian paths

A **Hamiltonian path** is a path that visits each node of the graph exactly once. For example, the graph

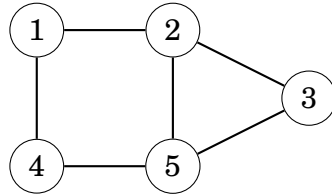

contains a Hamiltonian path from node 1 to node 3:

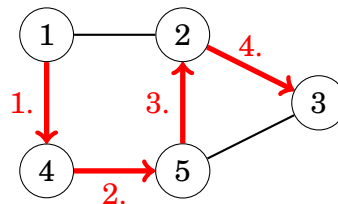

If a Hamiltonian path begins and ends at the same node, it is called a **Hamiltonian circuit**. The graph above also has an Hamiltonian circuit that begins and ends at node 1:

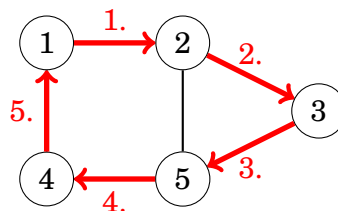

### Existence

No efficient method is known for testing if a graph contains a Hamiltonian path, and the problem is NP-hard. Still, in some special cases, we can be certain that a graph contains a Hamiltonian path.

A simple observation is that if the graph is complete, i.e., there is an edge between all pairs of nodes, it also contains a Hamiltonian path. Also stronger results have been achieved:

- **Dirac's theorem:** If the degree of each node is at least  $n/2$ , the graph contains a Hamiltonian path.
- **Ore's theorem:** If the sum of degrees of each non-adjacent pair of nodes is at least  $n$ , the graph contains a Hamiltonian path.

A common property in these theorems and other results is that they guarantee the existence of a Hamiltonian path if the graph has a *large number* of edges. This makes sense, because the more edges the graph contains, the more possibilities there is to construct a Hamiltonian path.

## Construction

Since there is no efficient way to check if a Hamiltonian path exists, it is clear that there is also no method to efficiently construct the path, because otherwise we could just try to construct the path and see whether it exists.

A simple way to search for a Hamiltonian path is to use a backtracking algorithm that goes through all possible ways to construct the path. The time complexity of such an algorithm is at least  $O(n!)$ , because there are  $n!$  different ways to choose the order of  $n$  nodes.

A more efficient solution is based on dynamic programming (see Chapter 10.5). The idea is to calculate values of a function  $\text{possible}(S, x)$ , where  $S$  is a subset of nodes and  $x$  is one of the nodes. The function indicates whether there is a Hamiltonian path that visits the nodes of  $S$  and ends at node  $x$ . It is possible to implement this solution in  $O(2^n n^2)$  time.

## 19.3 De Bruijn sequences

A **De Bruijn sequence** is a string that contains every string of length  $n$  exactly once as a substring, for a fixed alphabet of  $k$  characters. The length of such a string is  $k^n + n - 1$  characters. For example, when  $n = 3$  and  $k = 2$ , an example of a De Bruijn sequence is

0001011100.

The substrings of this string are all combinations of three bits: 000, 001, 010, 011, 100, 101, 110 and 111.

It turns out that each De Bruijn sequence corresponds to an Eulerian path in a graph. The idea is to construct a graph where each node contains a string of  $n - 1$  characters and each edge adds one character to the string. The following graph corresponds to the above scenario:

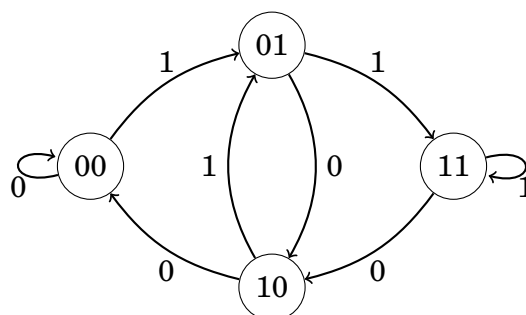

An Eulerian path in this graph corresponds to a string that contains all strings of length  $n$ . The string contains the characters of the starting node and all characters of the edges. The starting node has  $n - 1$  characters and there are  $k^n$  characters in the edges, so the length of the string is  $k^n + n - 1$ .

## 19.4 Knight's tours

A **knight's tour** is a sequence of moves of a knight on an  $n \times n$  chessboard following the rules of chess such that the knight visits each square exactly once. A knight's tour is called a *closed* tour if the knight finally returns to the starting square and otherwise it is called an *open* tour.

For example, here is an open knight's tour on a  $5 \times 5$  board:

|    |    |    |    |    |
|----|----|----|----|----|
| 1  | 4  | 11 | 16 | 25 |
| 12 | 17 | 2  | 5  | 10 |
| 3  | 20 | 7  | 24 | 15 |
| 18 | 13 | 22 | 9  | 6  |
| 21 | 8  | 19 | 14 | 23 |

A knight's tour corresponds to a Hamiltonian path in a graph whose nodes represent the squares of the board, and two nodes are connected with an edge if a knight can move between the squares according to the rules of chess.

A natural way to construct a knight's tour is to use backtracking. The search can be made more efficient by using *heuristics* that attempt to guide the knight so that a complete tour will be found quickly.

### Warnsdorf's rule

**Warnsdorf's rule** is a simple and effective heuristic for finding a knight's tour<sup>3</sup>. Using the rule, it is possible to efficiently construct a tour even on a large board. The idea is to always move the knight so that it ends up in a square where the number of possible moves is as *small* as possible.

For example, in the following situation, there are five possible squares to which the knight can move (squares  $a \dots e$ ):

|     |     |   |     |     |
|-----|-----|---|-----|-----|
| 1   |     |   |     | $a$ |
|     |     | 2 |     |     |
| $b$ |     |   |     | $e$ |
|     | $c$ |   | $d$ |     |
|     |     |   |     |     |

In this situation, Warnsdorf's rule moves the knight to square  $a$ , because after this choice, there is only a single possible move. The other choices would move the knight to squares where there would be three moves available.

---

<sup>3</sup>This heuristic was proposed in Warnsdorf's book [69] in 1823. There are also polynomial algorithms for finding knight's tours [53], but they are more complicated.



# Chapter 20

## Flows and cuts

In this chapter, we focus on the following two problems:

- **Finding a maximum flow:** What is the maximum amount of flow we can send from a node to another node?
- **Finding a minimum cut:** What is a minimum-weight set of edges that separates two nodes of the graph?

The input for both these problems is a directed, weighted graph that contains two special nodes: the *source* is a node with no incoming edges, and the *sink* is a node with no outgoing edges.

As an example, we will use the following graph where node 1 is the source and node 6 is the sink:

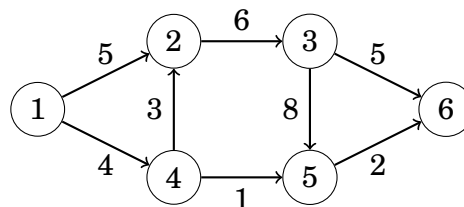

### Maximum flow

In the **maximum flow** problem, our task is to send as much flow as possible from the source to the sink. The weight of each edge is a capacity that restricts the flow that can go through the edge. In each intermediate node, the incoming and outgoing flow has to be equal.

For example, the maximum size of a flow in the example graph is 7. The following picture shows how we can route the flow:

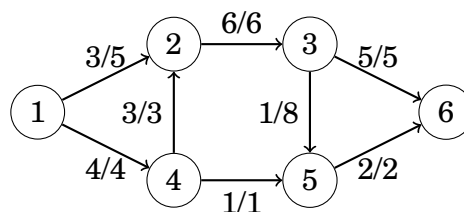

The notation  $v/k$  means that a flow of  $v$  units is routed through an edge whose capacity is  $k$  units. The size of the flow is 7, because the source sends  $3 + 4$  units of flow and the sink receives  $5 + 2$  units of flow. It is easy to see that this flow is maximum, because the total capacity of the edges leading to the sink is 7.

## Minimum cut

In the **minimum cut** problem, our task is to remove a set of edges from the graph such that there will be no path from the source to the sink after the removal and the total weight of the removed edges is minimum.

The minimum size of a cut in the example graph is 7. It suffices to remove the edges  $2 \rightarrow 3$  and  $4 \rightarrow 5$ :

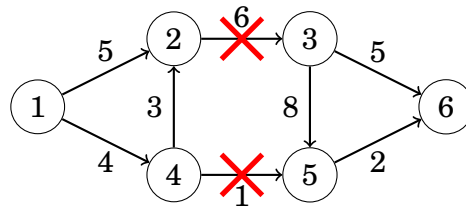

After removing the edges, there will be no path from the source to the sink. The size of the cut is 7, because the weights of the removed edges are 6 and 1. The cut is minimum, because there is no valid way to remove edges from the graph such that their total weight would be less than 7.

It is not a coincidence that the maximum size of a flow and the minimum size of a cut are the same in the above example. It turns out that a maximum flow and a minimum cut are *always* equally large, so the concepts are two sides of the same coin.

Next we will discuss the Ford–Fulkerson algorithm that can be used to find the maximum flow and minimum cut of a graph. The algorithm also helps us to understand *why* they are equally large.

## 20.1 Ford–Fulkerson algorithm

The **Ford–Fulkerson algorithm** [25] finds the maximum flow in a graph. The algorithm begins with an empty flow, and at each step finds a path from the source to the sink that generates more flow. Finally, when the algorithm cannot increase the flow anymore, the maximum flow has been found.

The algorithm uses a special representation of the graph where each original edge has a reverse edge in another direction. The weight of each edge indicates how much more flow we could route through it. At the beginning of the algorithm, the weight of each original edge equals the capacity of the edge and the weight of each reverse edge is zero.



The new representation for the example graph is as follows:

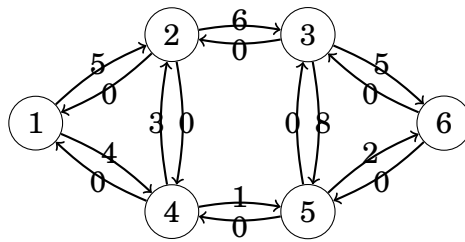

## Algorithm description

The Ford–Fulkerson algorithm consists of several rounds. On each round, the algorithm finds a path from the source to the sink such that each edge on the path has a positive weight. If there is more than one possible path available, we can choose any of them.

For example, suppose we choose the following path:

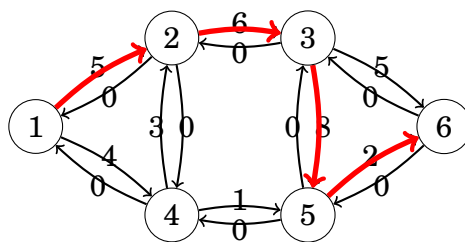

After choosing the path, the flow increases by  $x$  units, where  $x$  is the smallest edge weight on the path. In addition, the weight of each edge on the path decreases by  $x$  and the weight of each reverse edge increases by  $x$ .

In the above path, the weights of the edges are 5, 6, 8 and 2. The smallest weight is 2, so the flow increases by 2 and the new graph is as follows:

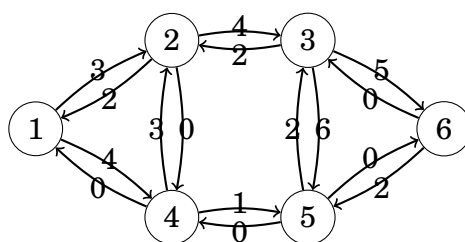

The idea is that increasing the flow decreases the amount of flow that can go through the edges in the future. On the other hand, it is possible to cancel flow later using the reverse edges of the graph if it turns out that it would be beneficial to route the flow in another way.

The algorithm increases the flow as long as there is a path from the source to the sink through positive-weight edges. In the present example, our next path can be as follows:

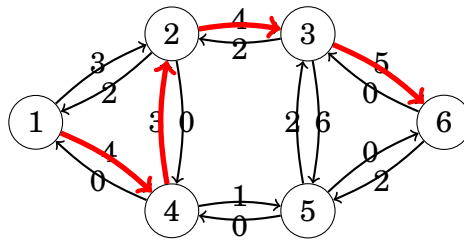

The minimum edge weight on this path is 3, so the path increases the flow by 3, and the total flow after processing the path is 5.

The new graph will be as follows:

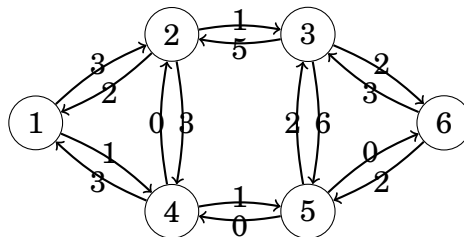

We still need two more rounds before reaching the maximum flow. For example, we can choose the paths  $1 \rightarrow 2 \rightarrow 3 \rightarrow 6$  and  $1 \rightarrow 4 \rightarrow 5 \rightarrow 3 \rightarrow 6$ . Both paths increase the flow by 1, and the final graph is as follows:

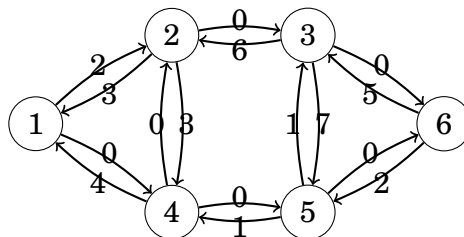

It is not possible to increase the flow anymore, because there is no path from the source to the sink with positive edge weights. Hence, the algorithm terminates and the maximum flow is 7.

## Finding paths

The Ford–Fulkerson algorithm does not specify how we should choose the paths that increase the flow. In any case, the algorithm will terminate sooner or later and correctly find the maximum flow. However, the efficiency of the algorithm depends on the way the paths are chosen.

A simple way to find paths is to use depth-first search. Usually, this works well, but in the worst case, each path only increases the flow by 1 and the algorithm is slow. Fortunately, we can avoid this situation by using one of the following techniques:

The **Edmonds–Karp algorithm** [18] chooses each path so that the number of edges on the path is as small as possible. This can be done by using breadth-first search instead of depth-first search for finding paths. It can be proven that

this guarantees that the flow increases quickly, and the time complexity of the algorithm is  $O(m^2n)$ .

The **scaling algorithm** [2] uses depth-first search to find paths where each edge weight is at least a threshold value. Initially, the threshold value is some large number, for example the sum of all edge weights of the graph. Always when a path cannot be found, the threshold value is divided by 2. The time complexity of the algorithm is  $O(m^2 \log c)$ , where  $c$  is the initial threshold value.

In practice, the scaling algorithm is easier to implement, because depth-first search can be used for finding paths. Both algorithms are efficient enough for problems that typically appear in programming contests.

## Minimum cuts

It turns out that once the Ford–Fulkerson algorithm has found a maximum flow, it has also determined a minimum cut. Let  $A$  be the set of nodes that can be reached from the source using positive-weight edges. In the example graph,  $A$  contains nodes 1, 2 and 4:

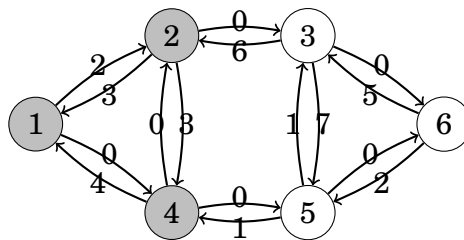

Now the minimum cut consists of the edges of the original graph that start at some node in  $A$ , end at some node outside  $A$ , and whose capacity is fully used in the maximum flow. In the above graph, such edges are  $2 \rightarrow 3$  and  $4 \rightarrow 5$ , that correspond to the minimum cut  $6 + 1 = 7$ .

Why is the flow produced by the algorithm maximum and why is the cut minimum? The reason is that a graph cannot contain a flow whose size is larger than the weight of any cut of the graph. Hence, always when a flow and a cut are equally large, they are a maximum flow and a minimum cut.

Let us consider any cut of the graph such that the source belongs to  $A$ , the sink belongs to  $B$  and there are some edges between the sets:

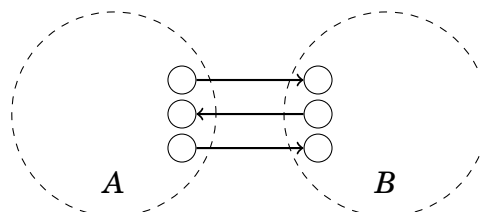

The size of the cut is the sum of the edges that go from  $A$  to  $B$ . This is an upper bound for the flow in the graph, because the flow has to proceed from  $A$  to  $B$ . Thus, the size of a maximum flow is smaller than or equal to the size of any cut in the graph.

On the other hand, the Ford–Fulkerson algorithm produces a flow whose size is *exactly* as large as the size of a cut in the graph. Thus, the flow has to be a maximum flow and the cut has to be a minimum cut.

## 20.2 Disjoint paths

Many graph problems can be solved by reducing them to the maximum flow problem. Our first example of such a problem is as follows: we are given a directed graph with a source and a sink, and our task is to find the maximum number of disjoint paths from the source to the sink.

### Edge-disjoint paths

We will first focus on the problem of finding the maximum number of **edge-disjoint paths** from the source to the sink. This means that we should construct a set of paths such that each edge appears in at most one path.

For example, consider the following graph:

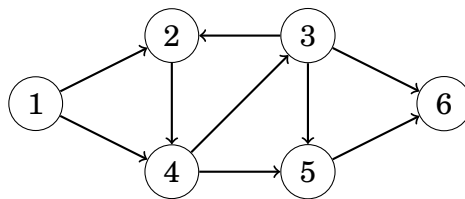

In this graph, the maximum number of edge-disjoint paths is 2. We can choose the paths  $1 \rightarrow 2 \rightarrow 4 \rightarrow 3 \rightarrow 6$  and  $1 \rightarrow 4 \rightarrow 5 \rightarrow 6$  as follows:

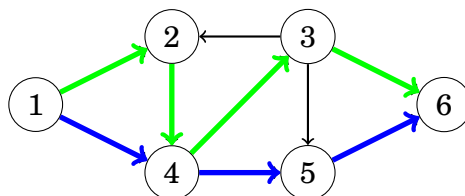

It turns out that the maximum number of edge-disjoint paths equals the maximum flow of the graph, assuming that the capacity of each edge is one. After the maximum flow has been constructed, the edge-disjoint paths can be found greedily by following paths from the source to the sink.

### Node-disjoint paths

Let us now consider another problem: finding the maximum number of **node-disjoint paths** from the source to the sink. In this problem, every node, except for the source and sink, may appear in at most one path. The number of node-disjoint paths may be smaller than the number of edge-disjoint paths.

For example, in the previous graph, the maximum number of node-disjoint paths is 1:

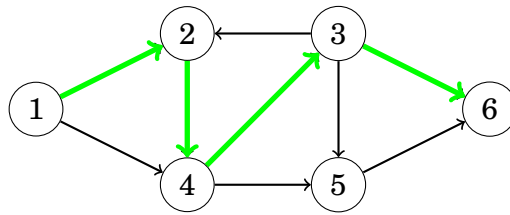

We can reduce also this problem to the maximum flow problem. Since each node can appear in at most one path, we have to limit the flow that goes through the nodes. A standard method for this is to divide each node into two nodes such that the first node has the incoming edges of the original node, the second node has the outgoing edges of the original node, and there is a new edge from the first node to the second node.

In our example, the graph becomes as follows:

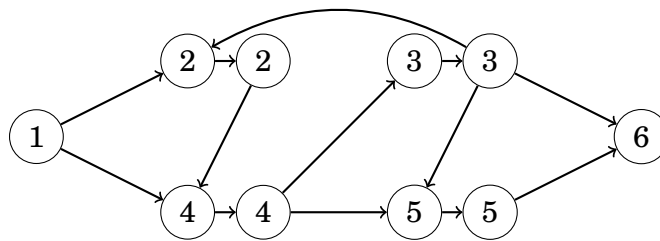

The maximum flow for the graph is as follows:

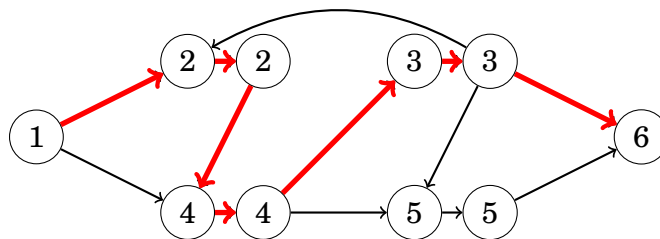

Thus, the maximum number of node-disjoint paths from the source to the sink is 1.

## 20.3 Maximum matchings

The **maximum matching** problem asks to find a maximum-size set of node pairs in an undirected graph such that each pair is connected with an edge and each node belongs to at most one pair.

There are polynomial algorithms for finding maximum matchings in general graphs [17], but such algorithms are complex and rarely seen in programming contests. However, in bipartite graphs, the maximum matching problem is much easier to solve, because we can reduce it to the maximum flow problem.

## Finding maximum matchings

The nodes of a bipartite graph can be always divided into two groups such that all edges of the graph go from the left group to the right group. For example, in the following bipartite graph, the groups are {1,2,3,4} and {5,6,7,8}.

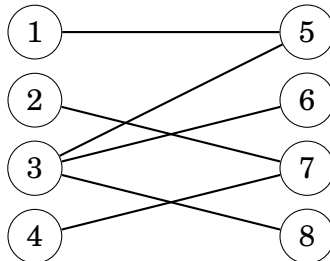

The size of a maximum matching of this graph is 3:

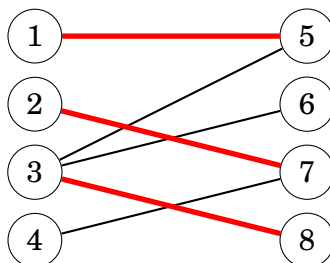

We can reduce the bipartite maximum matching problem to the maximum flow problem by adding two new nodes to the graph: a source and a sink. We also add edges from the source to each left node and from each right node to the sink. After this, the size of a maximum flow in the graph equals the size of a maximum matching in the original graph.

For example, the reduction for the above graph is as follows:

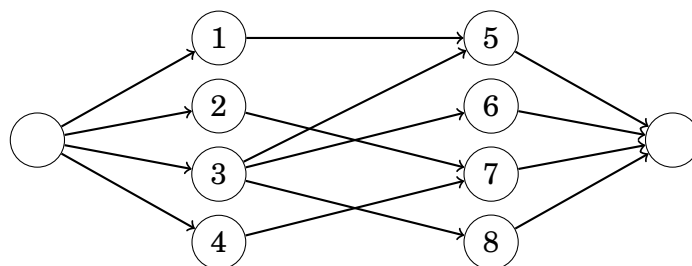

The maximum flow of this graph is as follows:

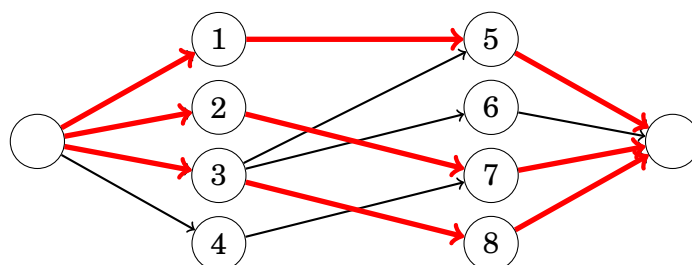

## Hall's theorem

**Hall's theorem** can be used to find out whether a bipartite graph has a matching that contains all left or right nodes. If the number of left and right nodes is the same, Hall's theorem tells us if it is possible to construct a **perfect matching** that contains all nodes of the graph.

Assume that we want to find a matching that contains all left nodes. Let  $X$  be any set of left nodes and let  $f(X)$  be the set of their neighbors. According to Hall's theorem, a matching that contains all left nodes exists exactly when for each  $X$ , the condition  $|X| \leq |f(X)|$  holds.

Let us study Hall's theorem in the example graph. First, let  $X = \{1, 3\}$  which yields  $f(X) = \{5, 6, 8\}$ :

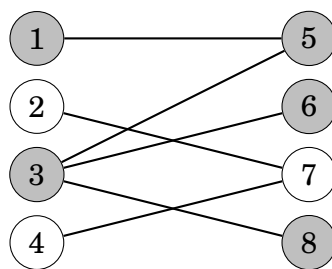

The condition of Hall's theorem holds, because  $|X| = 2$  and  $|f(X)| = 3$ . Next, let  $X = \{2, 4\}$  which yields  $f(X) = \{7\}$ :

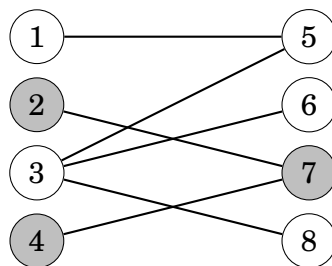

In this case,  $|X| = 2$  and  $|f(X)| = 1$ , so the condition of Hall's theorem does not hold. This means that it is not possible to form a perfect matching for the graph. This result is not surprising, because we already know that the maximum matching of the graph is 3 and not 4.

If the condition of Hall's theorem does not hold, the set  $X$  provides an explanation *why* we cannot form such a matching. Since  $X$  contains more nodes than  $f(X)$ , there are no pairs for all nodes in  $X$ . For example, in the above graph, both nodes 2 and 4 should be connected with node 7 which is not possible.

## König's theorem

A **minimum node cover** of a graph is a minimum set of nodes such that each edge of the graph has at least one endpoint in the set. In a general graph, finding a minimum node cover is a NP-hard problem. However, if the graph is bipartite, **König's theorem** tells us that the size of a minimum node cover and the size

of a maximum matching are always equal. Thus, we can calculate the size of a minimum node cover using a maximum flow algorithm.

Let us consider the following graph with a maximum matching of size 3:

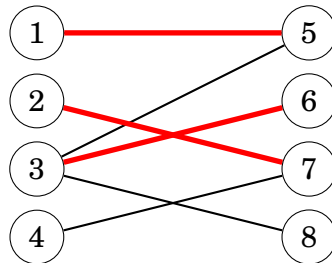

Now König's theorem tells us that the size of a minimum node cover is also 3. Such a cover can be constructed as follows:

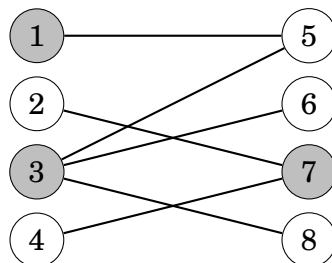

The nodes that do *not* belong to a minimum node cover form a **maximum independent set**. This is the largest possible set of nodes such that no two nodes in the set are connected with an edge. Once again, finding a maximum independent set in a general graph is a NP-hard problem, but in a bipartite graph we can use König's theorem to solve the problem efficiently. In the example graph, the maximum independent set is as follows:

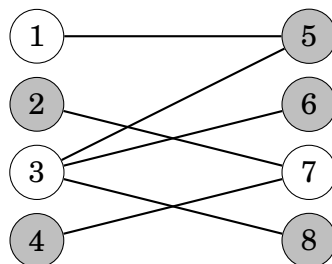

## 20.4 Path covers

A **path cover** is a set of paths in a graph such that each node of the graph belongs to at least one path. It turns out that in directed, acyclic graphs, we can reduce the problem of finding a minimum path cover to the problem of finding a maximum flow in another graph.



## Node-disjoint path cover

In a **node-disjoint path cover**, each node belongs to exactly one path. As an example, consider the following graph:

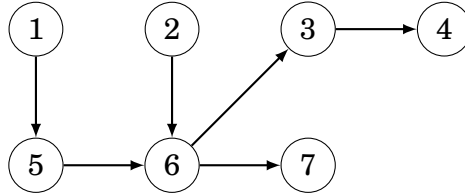

A minimum node-disjoint path cover of this graph consists of three paths. For example, we can choose the following paths:

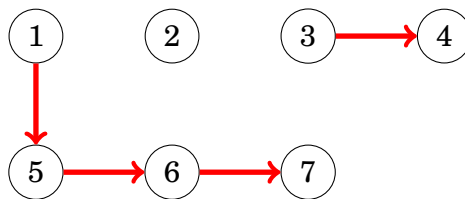

Note that one of the paths only contains node 2, so it is possible that a path does not contain any edges.

We can find a minimum node-disjoint path cover by constructing a *matching graph* where each node of the original graph is represented by two nodes: a left node and a right node. There is an edge from a left node to a right node if there is such an edge in the original graph. In addition, the matching graph contains a source and a sink, and there are edges from the source to all left nodes and from all right nodes to the sink.

A maximum matching in the resulting graph corresponds to a minimum node-disjoint path cover in the original graph. For example, the following matching graph for the above graph contains a maximum matching of size 4:

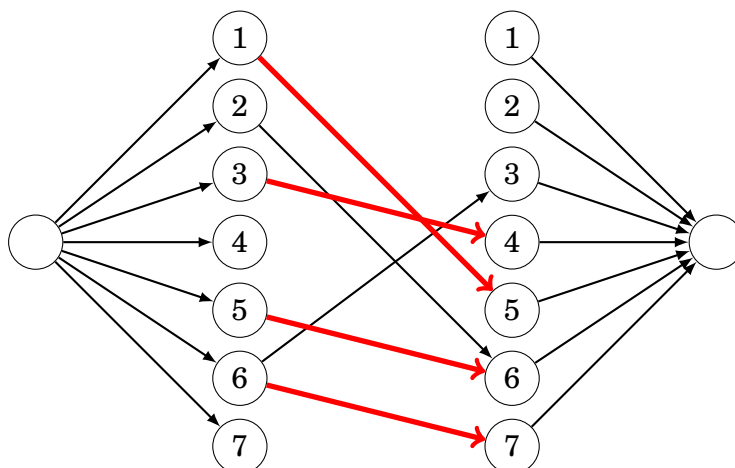

Each edge in the maximum matching of the matching graph corresponds to an edge in the minimum node-disjoint path cover of the original graph. Thus, the size of the minimum node-disjoint path cover is  $n - c$ , where  $n$  is the number of nodes in the original graph and  $c$  is the size of the maximum matching.

## General path cover

A **general path cover** is a path cover where a node can belong to more than one path. A minimum general path cover may be smaller than a minimum node-disjoint path cover, because a node can be used multiple times in paths. Consider again the following graph:

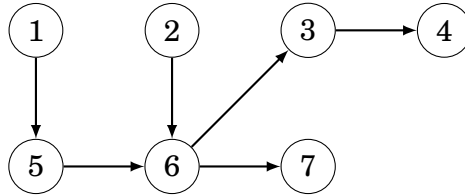

The minimum general path cover of this graph consists of two paths. For example, the first path may be as follows:

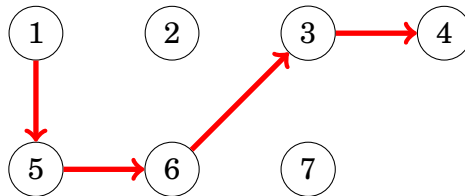

And the second path may be as follows:

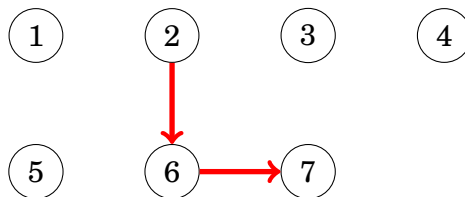

A minimum general path cover can be found almost like a minimum node-disjoint path cover. It suffices to add some new edges to the matching graph so that there is an edge  $a \rightarrow b$  always when there is a path from  $a$  to  $b$  in the original graph (possibly through several edges).

The matching graph for the above graph is as follows:

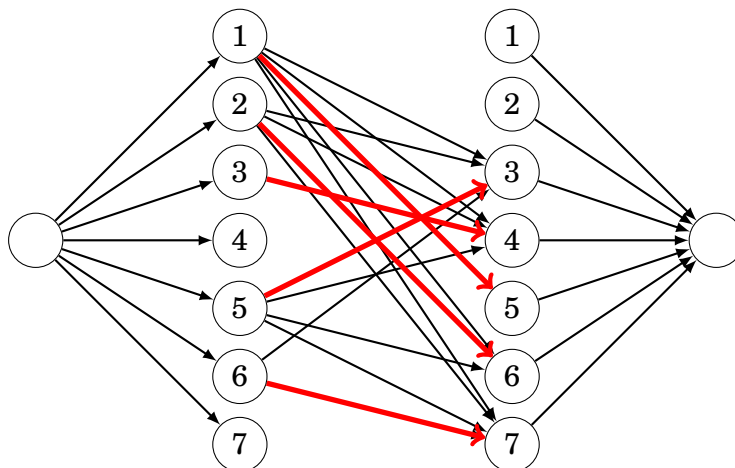

## Dilworth's theorem

An **antichain** is a set of nodes of a graph such that there is no path from any node to another node using the edges of the graph. **Dilworth's theorem** states that in a directed acyclic graph, the size of a minimum general path cover equals the size of a maximum antichain.

For example, nodes 3 and 7 form an antichain in the following graph:

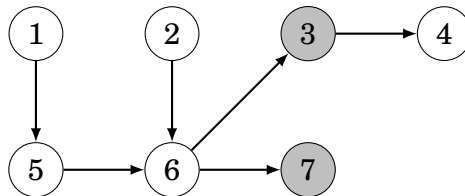

This is a maximum antichain, because it is not possible to construct any antichain that would contain three nodes. We have seen before that the size of a minimum general path cover of this graph consists of two paths.



**Part III**  
**Advanced topics**



# Chapter 21

## Number theory

**Number theory** is a branch of mathematics that studies integers. Number theory is a fascinating field, because many questions involving integers are very difficult to solve even if they seem simple at first glance.

As an example, consider the following equation:

$$x^3 + y^3 + z^3 = 33$$

It is easy to find three real numbers  $x$ ,  $y$  and  $z$  that satisfy the equation. For example, we can choose

$$\begin{aligned}x &= 3, \\y &= \sqrt[3]{3}, \\z &= \sqrt[3]{3}.\end{aligned}$$

However, it is an open problem in number theory if there are any three *integers*  $x$ ,  $y$  and  $z$  that would satisfy the equation [6].

In this chapter, we will focus on basic concepts and algorithms in number theory. Throughout the chapter, we will assume that all numbers are integers, if not otherwise stated.

### 21.1 Primes and factors

A number  $a$  is called a **factor** or a **divisor** of a number  $b$  if  $a$  divides  $b$ . If  $a$  is a factor of  $b$ , we write  $a \mid b$ , and otherwise we write  $a \nmid b$ . For example, the factors of 24 are 1, 2, 3, 4, 6, 8, 12 and 24.

A number  $n > 1$  is a **prime** if its only positive factors are 1 and  $n$ . For example, 7, 19 and 41 are primes, but 35 is not a prime, because  $5 \cdot 7 = 35$ . For every number  $n > 1$ , there is a unique **prime factorization**

$$n = p_1^{\alpha_1} p_2^{\alpha_2} \cdots p_k^{\alpha_k},$$

where  $p_1, p_2, \dots, p_k$  are distinct primes and  $\alpha_1, \alpha_2, \dots, \alpha_k$  are positive numbers. For example, the prime factorization for 84 is

$$84 = 2^2 \cdot 3^1 \cdot 7^1.$$

The **number of factors** of a number  $n$  is

$$\tau(n) = \prod_{i=1}^k (\alpha_i + 1),$$

because for each prime  $p_i$ , there are  $\alpha_i + 1$  ways to choose how many times it appears in the factor. For example, the number of factors of 84 is  $\tau(84) = 3 \cdot 2 \cdot 2 = 12$ . The factors are 1, 2, 3, 4, 6, 7, 12, 14, 21, 28, 42 and 84.

The **sum of factors** of  $n$  is

$$\sigma(n) = \prod_{i=1}^k (1 + p_i + \dots + p_i^{\alpha_i}) = \prod_{i=1}^k \frac{p_i^{\alpha_i+1} - 1}{p_i - 1},$$

where the latter formula is based on the geometric progression formula. For example, the sum of factors of 84 is

$$\sigma(84) = \frac{2^3 - 1}{2 - 1} \cdot \frac{3^2 - 1}{3 - 1} \cdot \frac{7^2 - 1}{7 - 1} = 7 \cdot 4 \cdot 8 = 224.$$

The **product of factors** of  $n$  is

$$\mu(n) = n^{\tau(n)/2},$$

because we can form  $\tau(n)/2$  pairs from the factors, each with product  $n$ . For example, the factors of 84 produce the pairs  $1 \cdot 84$ ,  $2 \cdot 42$ ,  $3 \cdot 28$ , etc., and the product of the factors is  $\mu(84) = 84^6 = 351298031616$ .

A number  $n$  is called a **perfect number** if  $n = \sigma(n) - n$ , i.e.,  $n$  equals the sum of its factors between 1 and  $n - 1$ . For example, 28 is a perfect number, because  $28 = 1 + 2 + 4 + 7 + 14$ .

## Number of primes

It is easy to show that there is an infinite number of primes. If the number of primes would be finite, we could construct a set  $P = \{p_1, p_2, \dots, p_n\}$  that would contain all the primes. For example,  $p_1 = 2$ ,  $p_2 = 3$ ,  $p_3 = 5$ , and so on. However, using  $P$ , we could form a new prime

$$p_1 p_2 \cdots p_n + 1$$

that is larger than all elements in  $P$ . This is a contradiction, and the number of primes has to be infinite.

## Density of primes

The density of primes means how often there are primes among the numbers. Let  $\pi(n)$  denote the number of primes between 1 and  $n$ . For example,  $\pi(10) = 4$ , because there are 4 primes between 1 and 10: 2, 3, 5 and 7.

It is possible to show that

$$\pi(n) \approx \frac{n}{\ln n},$$

which means that primes are quite frequent. For example, the number of primes between 1 and  $10^6$  is  $\pi(10^6) = 78498$ , and  $10^6 / \ln 10^6 \approx 72382$ .



## Conjectures

There are many *conjectures* involving primes. Most people think that the conjectures are true, but nobody has been able to prove them. For example, the following conjectures are famous:

- **Goldbach's conjecture:** Each even integer  $n > 2$  can be represented as a sum  $n = a + b$  so that both  $a$  and  $b$  are primes.
- **Twin prime conjecture:** There is an infinite number of pairs of the form  $\{p, p + 2\}$ , where both  $p$  and  $p + 2$  are primes.
- **Legendre's conjecture:** There is always a prime between numbers  $n^2$  and  $(n + 1)^2$ , where  $n$  is any positive integer.

## Basic algorithms

If a number  $n$  is not prime, it can be represented as a product  $a \cdot b$ , where  $a \leq \sqrt{n}$  or  $b \leq \sqrt{n}$ , so it certainly has a factor between 2 and  $\lfloor \sqrt{n} \rfloor$ . Using this observation, we can both test if a number is prime and find the prime factorization of a number in  $O(\sqrt{n})$  time.

The following function `prime` checks if the given number  $n$  is prime. The function attempts to divide  $n$  by all numbers between 2 and  $\lfloor \sqrt{n} \rfloor$ , and if none of them divides  $n$ , then  $n$  is prime.

```
bool prime(int n) {
    if (n < 2) return false;
    for (int x = 2; x*x <= n; x++) {
        if (n%x == 0) return false;
    }
    return true;
}
```

The following function `factors` constructs a vector that contains the prime factorization of  $n$ . The function divides  $n$  by its prime factors, and adds them to the vector. The process ends when the remaining number  $n$  has no factors between 2 and  $\lfloor \sqrt{n} \rfloor$ . If  $n > 1$ , it is prime and the last factor.

```
vector<int> factors(int n) {
    vector<int> f;
    for (int x = 2; x*x <= n; x++) {
        while (n%x == 0) {
            f.push_back(x);
            n /= x;
        }
    }
    if (n > 1) f.push_back(n);
    return f;
}
```

Note that each prime factor appears in the vector as many times as it divides the number. For example,  $24 = 2^3 \cdot 3$ , so the result of the function is  $[2, 2, 2, 3]$ .

## Sieve of Eratosthenes

The **sieve of Eratosthenes** is a preprocessing algorithm that builds an array using which we can efficiently check if a given number between  $2 \dots n$  is prime and, if it is not, find one prime factor of the number.

The algorithm builds an array sieve whose positions  $2, 3, \dots, n$  are used. The value  $\text{sieve}[k] = 0$  means that  $k$  is prime, and the value  $\text{sieve}[k] \neq 0$  means that  $k$  is not a prime and one of its prime factors is  $\text{sieve}[k]$ .

The algorithm iterates through the numbers  $2 \dots n$  one by one. Always when a new prime  $x$  is found, the algorithm records that the multiples of  $x$  ( $2x, 3x, 4x, \dots$ ) are not primes, because the number  $x$  divides them.

For example, if  $n = 20$ , the array is as follows:

|   |   |   |   |   |   |   |   |    |    |    |    |    |    |    |    |    |    |    |
|---|---|---|---|---|---|---|---|----|----|----|----|----|----|----|----|----|----|----|
| 2 | 3 | 4 | 5 | 6 | 7 | 8 | 9 | 10 | 11 | 12 | 13 | 14 | 15 | 16 | 17 | 18 | 19 | 20 |
| 0 | 0 | 2 | 0 | 3 | 0 | 2 | 3 | 5  | 0  | 3  | 0  | 7  | 5  | 2  | 0  | 3  | 0  | 5  |

The following code implements the sieve of Eratosthenes. The code assumes that each element of sieve is initially zero.

```

for (int x = 2; x <= n; x++) {
    if (sieve[x]) continue;
    for (int u = 2*x; u <= n; u += x) {
        sieve[u] = x;
    }
}

```

The inner loop of the algorithm is executed  $n/x$  times for each value of  $x$ . Thus, an upper bound for the running time of the algorithm is the harmonic sum

$$\sum_{x=2}^n n/x = n/2 + n/3 + n/4 + \dots + n/n = O(n \log n).$$

In fact, the algorithm is more efficient, because the inner loop will be executed only if the number  $x$  is prime. It can be shown that the running time of the algorithm is only  $O(n \log \log n)$ , a complexity very near to  $O(n)$ .

## Euclid's algorithm

The **greatest common divisor** of numbers  $a$  and  $b$ ,  $\text{gcd}(a, b)$ , is the greatest number that divides both  $a$  and  $b$ , and the **least common multiple** of  $a$  and  $b$ ,  $\text{lcm}(a, b)$ , is the smallest number that is divisible by both  $a$  and  $b$ . For example,  $\text{gcd}(24, 36) = 12$  and  $\text{lcm}(24, 36) = 72$ .

The greatest common divisor and the least common multiple are connected as follows:

$$\text{lcm}(a, b) = \frac{ab}{\text{gcd}(a, b)}$$

**Euclid's algorithm**<sup>1</sup> provides an efficient way to find the greatest common divisor of two numbers. The algorithm is based on the following formula:

$$\gcd(a, b) = \begin{cases} a & b = 0 \\ \gcd(b, a \bmod b) & b \neq 0 \end{cases}$$

For example,

$$\gcd(24, 36) = \gcd(36, 24) = \gcd(24, 12) = \gcd(12, 0) = 12.$$

The algorithm can be implemented as follows:

```
int gcd(int a, int b) {
    if (b == 0) return a;
    return gcd(b, a%b);
}
```

It can be shown that Euclid's algorithm works in  $O(\log n)$  time, where  $n = \min(a, b)$ . The worst case for the algorithm is the case when  $a$  and  $b$  are consecutive Fibonacci numbers. For example,

$$\gcd(13, 8) = \gcd(8, 5) = \gcd(5, 3) = \gcd(3, 2) = \gcd(2, 1) = \gcd(1, 0) = 1.$$

## Euler's totient function

Numbers  $a$  and  $b$  are **coprime** if  $\gcd(a, b) = 1$ . **Euler's totient function**  $\varphi(n)$  gives the number of coprime numbers to  $n$  between 1 and  $n$ . For example,  $\varphi(12) = 4$ , because 1, 5, 7 and 11 are coprime to 12.

The value of  $\varphi(n)$  can be calculated from the prime factorization of  $n$  using the formula

$$\varphi(n) = \prod_{i=1}^k p_i^{\alpha_i - 1} (p_i - 1).$$

For example,  $\varphi(12) = 2^1 \cdot (2 - 1) \cdot 3^0 \cdot (3 - 1) = 4$ . Note that  $\varphi(n) = n - 1$  if  $n$  is prime.

## 21.2 Modular arithmetic

In **modular arithmetic**, the set of numbers is limited so that only numbers  $0, 1, 2, \dots, m - 1$  are used, where  $m$  is a constant. Each number  $x$  is represented by the number  $x \bmod m$ : the remainder after dividing  $x$  by  $m$ . For example, if  $m = 17$ , then 75 is represented by  $75 \bmod 17 = 7$ .

Often we can take remainders before doing calculations. In particular, the following formulas hold:

$$\begin{aligned} (x + y) \bmod m &= (x \bmod m + y \bmod m) \bmod m \\ (x - y) \bmod m &= (x \bmod m - y \bmod m) \bmod m \\ (x \cdot y) \bmod m &= (x \bmod m \cdot y \bmod m) \bmod m \\ x^n \bmod m &= (x \bmod m)^n \bmod m \end{aligned}$$

<sup>1</sup>Euclid was a Greek mathematician who lived in about 300 BC. This is perhaps the first known algorithm in history.

## Modular exponentiation

There is often need to efficiently calculate the value of  $x^n \bmod m$ . This can be done in  $O(\log n)$  time using the following recursion:

$$x^n = \begin{cases} 1 & n = 0 \\ x^{n/2} \cdot x^{n/2} & n \text{ is even} \\ x^{n-1} \cdot x & n \text{ is odd} \end{cases}$$

It is important that in the case of an even  $n$ , the value of  $x^{n/2}$  is calculated only once. This guarantees that the time complexity of the algorithm is  $O(\log n)$ , because  $n$  is always halved when it is even.

The following function calculates the value of  $x^n \bmod m$ :

```
int modpow(int x, int n, int m) {
    if (n == 0) return 1%m;
    int u = modpow(x, n/2, m);
    u = (u*u)%m;
    if (n%2 == 1) u = (u*x)%m;
    return u;
}
```

## Fermat's theorem and Euler's theorem

**Fermat's theorem** states that

$$x^{m-1} \bmod m = 1$$

when  $m$  is prime and  $x$  and  $m$  are coprime. This also yields

$$x^k \bmod m = x^{k \bmod (m-1)} \bmod m.$$

More generally, **Euler's theorem** states that

$$x^{\varphi(m)} \bmod m = 1$$

when  $x$  and  $m$  are coprime. Fermat's theorem follows from Euler's theorem, because if  $m$  is a prime, then  $\varphi(m) = m - 1$ .

## Modular inverse

The inverse of  $x$  modulo  $m$  is a number  $x^{-1}$  such that

$$xx^{-1} \bmod m = 1.$$

For example, if  $x = 6$  and  $m = 17$ , then  $x^{-1} = 3$ , because  $6 \cdot 3 \bmod 17 = 1$ .

Using modular inverses, we can divide numbers modulo  $m$ , because division by  $x$  corresponds to multiplication by  $x^{-1}$ . For example, to evaluate the value

of  $36/6 \bmod 17$ , we can use the formula  $2 \cdot 3 \bmod 17$ , because  $36 \bmod 17 = 2$  and  $6^{-1} \bmod 17 = 3$ .

However, a modular inverse does not always exist. For example, if  $x = 2$  and  $m = 4$ , the equation

$$xx^{-1} \bmod m = 1$$

cannot be solved, because all multiples of 2 are even and the remainder can never be 1 when  $m = 4$ . It turns out that the value of  $x^{-1} \bmod m$  can be calculated exactly when  $x$  and  $m$  are coprime.

If a modular inverse exists, it can be calculated using the formula

$$x^{-1} = x^{\varphi(m)-1}.$$

If  $m$  is prime, the formula becomes

$$x^{-1} = x^{m-2}.$$

For example,

$$6^{-1} \bmod 17 = 6^{17-2} \bmod 17 = 3.$$

This formula allows us to efficiently calculate modular inverses using the modular exponentiation algorithm. The formula can be derived using Euler's theorem. First, the modular inverse should satisfy the following equation:

$$xx^{-1} \bmod m = 1.$$

On the other hand, according to Euler's theorem,

$$x^{\varphi(m)} \bmod m = xx^{\varphi(m)-1} \bmod m = 1,$$

so the numbers  $x^{-1}$  and  $x^{\varphi(m)-1}$  are equal.

## Computer arithmetic

In programming, unsigned integers are represented modulo  $2^k$ , where  $k$  is the number of bits of the data type. A usual consequence of this is that a number wraps around if it becomes too large.

For example, in C++, numbers of type `unsigned int` are represented modulo  $2^{32}$ . The following code declares an `unsigned int` variable whose value is 123456789. After this, the value will be multiplied by itself, and the result is  $123456789^2 \bmod 2^{32} = 2537071545$ .

```
unsigned int x = 123456789;
cout << x*x << "\n"; // 2537071545
```

## 21.3 Solving equations

### Diophantine equations

A **Diophantine equation** is an equation of the form

$$ax + by = c,$$

where  $a$ ,  $b$  and  $c$  are constants and the values of  $x$  and  $y$  should be found. Each number in the equation has to be an integer. For example, one solution for the equation  $5x + 2y = 11$  is  $x = 3$  and  $y = -2$ .

We can efficiently solve a Diophantine equation by using Euclid's algorithm. It turns out that we can extend Euclid's algorithm so that it will find numbers  $x$  and  $y$  that satisfy the following equation:

$$ax + by = \gcd(a, b)$$

A Diophantine equation can be solved if  $c$  is divisible by  $\gcd(a, b)$ , and otherwise it cannot be solved.

As an example, let us find numbers  $x$  and  $y$  that satisfy the following equation:

$$39x + 15y = 12$$

The equation can be solved, because  $\gcd(39, 15) = 3$  and  $3 \mid 12$ . When Euclid's algorithm calculates the greatest common divisor of 39 and 15, it produces the following sequence of function calls:

$$\gcd(39, 15) = \gcd(15, 9) = \gcd(9, 6) = \gcd(6, 3) = \gcd(3, 0) = 3$$

This corresponds to the following equations:

$$\begin{aligned} 39 - 2 \cdot 15 &= 9 \\ 15 - 1 \cdot 9 &= 6 \\ 9 - 1 \cdot 6 &= 3 \end{aligned}$$

Using these equations, we can derive

$$39 \cdot 2 + 15 \cdot (-5) = 3$$

and by multiplying this by 4, the result is

$$39 \cdot 8 + 15 \cdot (-20) = 12,$$

so a solution to the equation is  $x = 8$  and  $y = -20$ .

A solution to a Diophantine equation is not unique, because we can form an infinite number of solutions if we know one solution. If a pair  $(x, y)$  is a solution, then also all pairs

$$\left(x + \frac{kb}{\gcd(a, b)}, y - \frac{ka}{\gcd(a, b)}\right)$$

are solutions, where  $k$  is any integer.

## Chinese remainder theorem

The **Chinese remainder theorem** solves a group of equations of the form

$$\begin{aligned}x &= a_1 \pmod{m_1} \\x &= a_2 \pmod{m_2} \\&\dots \\x &= a_n \pmod{m_n}\end{aligned}$$

where all pairs of  $m_1, m_2, \dots, m_n$  are coprime.

Let  $x_m^{-1}$  be the inverse of  $x$  modulo  $m$ , and

$$X_k = \frac{m_1 m_2 \cdots m_n}{m_k}.$$

Using this notation, a solution to the equations is

$$x = a_1 X_1 X_{1m_1}^{-1} + a_2 X_2 X_{2m_2}^{-1} + \cdots + a_n X_n X_{nm_n}^{-1}.$$

In this solution, for each  $k = 1, 2, \dots, n$ ,

$$a_k X_k X_{km_k}^{-1} \pmod{m_k} = a_k,$$

because

$$X_k X_{km_k}^{-1} \pmod{m_k} = 1.$$

Since all other terms in the sum are divisible by  $m_k$ , they have no effect on the remainder, and  $x \pmod{m_k} = a_k$ .

For example, a solution for

$$\begin{aligned}x &= 3 \pmod{5} \\x &= 4 \pmod{7} \\x &= 2 \pmod{3}\end{aligned}$$

is

$$3 \cdot 21 \cdot 1 + 4 \cdot 15 \cdot 1 + 2 \cdot 35 \cdot 2 = 263.$$

Once we have found a solution  $x$ , we can create an infinite number of other solutions, because all numbers of the form

$$x + m_1 m_2 \cdots m_n$$

are solutions.

## 21.4 Other results

### Lagrange's theorem

**Lagrange's theorem** states that every positive integer can be represented as a sum of four squares, i.e.,  $a^2 + b^2 + c^2 + d^2$ . For example, the number 123 can be represented as the sum  $8^2 + 5^2 + 5^2 + 3^2$ .

## Zeckendorf's theorem

**Zeckendorf's theorem** states that every positive integer has a unique representation as a sum of Fibonacci numbers such that no two numbers are equal or consecutive Fibonacci numbers. For example, the number 74 can be represented as the sum  $55 + 13 + 5 + 1$ .

## Pythagorean triples

A **Pythagorean triple** is a triple  $(a, b, c)$  that satisfies the Pythagorean theorem  $a^2 + b^2 = c^2$ , which means that there is a right triangle with side lengths  $a$ ,  $b$  and  $c$ . For example,  $(3, 4, 5)$  is a Pythagorean triple.

If  $(a, b, c)$  is a Pythagorean triple, all triples of the form  $(ka, kb, kc)$  are also Pythagorean triples where  $k > 1$ . A Pythagorean triple is *primitive* if  $a$ ,  $b$  and  $c$  are coprime, and all Pythagorean triples can be constructed from primitive triples using a multiplier  $k$ .

**Euclid's formula** can be used to produce all primitive Pythagorean triples. Each such triple is of the form

$$(n^2 - m^2, 2nm, n^2 + m^2),$$

where  $0 < m < n$ ,  $n$  and  $m$  are coprime and at least one of  $n$  and  $m$  is even. For example, when  $m = 1$  and  $n = 2$ , the formula produces the smallest Pythagorean triple

$$(2^2 - 1^2, 2 \cdot 2 \cdot 1, 2^2 + 1^2) = (3, 4, 5).$$

## Wilson's theorem

**Wilson's theorem** states that a number  $n$  is prime exactly when

$$(n - 1)! \bmod n = n - 1.$$

For example, the number 11 is prime, because

$$10! \bmod 11 = 10,$$

and the number 12 is not prime, because

$$11! \bmod 12 = 0 \neq 11.$$

Hence, Wilson's theorem can be used to find out whether a number is prime. However, in practice, the theorem cannot be applied to large values of  $n$ , because it is difficult to calculate values of  $(n - 1)!$  when  $n$  is large.



# Chapter 22

## Combinatorics

**Combinatorics** studies methods for counting combinations of objects. Usually, the goal is to find a way to count the combinations efficiently without generating each combination separately.

As an example, consider the problem of counting the number of ways to represent an integer  $n$  as a sum of positive integers. For example, there are 8 representations for 4:

- $1 + 1 + 1 + 1$
- $1 + 1 + 2$
- $1 + 2 + 1$
- $2 + 1 + 1$
- $2 + 2$
- $3 + 1$
- $1 + 3$
- $4$

A combinatorial problem can often be solved using a recursive function. In this problem, we can define a function  $f(n)$  that gives the number of representations for  $n$ . For example,  $f(4) = 8$  according to the above example. The values of the function can be recursively calculated as follows:

$$f(n) = \begin{cases} 1 & n = 0 \\ f(0) + f(1) + \dots + f(n-1) & n > 0 \end{cases}$$

The base case is  $f(0) = 1$ , because the empty sum represents the number 0. Then, if  $n > 0$ , we consider all ways to choose the first number of the sum. If the first number is  $k$ , there are  $f(n - k)$  representations for the remaining part of the sum. Thus, we calculate the sum of all values of the form  $f(n - k)$  where  $k < n$ .

The first values for the function are:

$$\begin{aligned} f(0) &= 1 \\ f(1) &= 1 \\ f(2) &= 2 \\ f(3) &= 4 \\ f(4) &= 8 \end{aligned}$$

Sometimes, a recursive formula can be replaced with a closed-form formula. In this problem,

$$f(n) = 2^{n-1},$$

which is based on the fact that there are  $n - 1$  possible positions for  $+$ -signs in the sum and we can choose any subset of them.

## 22.1 Binomial coefficients

The **binomial coefficient**  $\binom{n}{k}$  equals the number of ways we can choose a subset of  $k$  elements from a set of  $n$  elements. For example,  $\binom{5}{3} = 10$ , because the set  $\{1, 2, 3, 4, 5\}$  has 10 subsets of 3 elements:

$\{1, 2, 3\}, \{1, 2, 4\}, \{1, 2, 5\}, \{1, 3, 4\}, \{1, 3, 5\}, \{1, 4, 5\}, \{2, 3, 4\}, \{2, 3, 5\}, \{2, 4, 5\}, \{3, 4, 5\}$

### Formula 1

Binomial coefficients can be recursively calculated as follows:

$$\binom{n}{k} = \binom{n-1}{k-1} + \binom{n-1}{k}$$

The idea is to fix an element  $x$  in the set. If  $x$  is included in the subset, we have to choose  $k - 1$  elements from  $n - 1$  elements, and if  $x$  is not included in the subset, we have to choose  $k$  elements from  $n - 1$  elements.

The base cases for the recursion are

$$\binom{n}{0} = \binom{n}{n} = 1,$$

because there is always exactly one way to construct an empty subset and a subset that contains all the elements.

### Formula 2

Another way to calculate binomial coefficients is as follows:

$$\binom{n}{k} = \frac{n!}{k!(n-k)!}.$$

There are  $n!$  permutations of  $n$  elements. We go through all permutations and always include the first  $k$  elements of the permutation in the subset. Since the order of the elements in the subset and outside the subset does not matter, the result is divided by  $k!$  and  $(n - k)!$

### Properties

For binomial coefficients,

$$\binom{n}{k} = \binom{n}{n-k},$$

because we actually divide a set of  $n$  elements into two subsets: the first contains  $k$  elements and the second contains  $n - k$  elements.

The sum of binomial coefficients is

$$\binom{n}{0} + \binom{n}{1} + \binom{n}{2} + \dots + \binom{n}{n} = 2^n.$$

The reason for the name "binomial coefficient" can be seen when the binomial  $(a + b)$  is raised to the  $n$ th power:

$$(a + b)^n = \binom{n}{0}a^n b^0 + \binom{n}{1}a^{n-1}b^1 + \dots + \binom{n}{n-1}a^1 b^{n-1} + \binom{n}{n}a^0 b^n.$$

Binomial coefficients also appear in **Pascal's triangle** where each value equals the sum of two above values:

|  |     |     |     |     |     |
|--|-----|-----|-----|-----|-----|
|  |     |     | 1   |     |     |
|  |     | 1   |     | 1   |     |
|  |     | 1   | 2   | 1   |     |
|  | 1   | 3   | 3   | 1   |     |
|  | 1   | 4   | 6   | 4   | 1   |
|  | ... | ... | ... | ... | ... |

## Boxes and balls

"Boxes and balls" is a useful model, where we count the ways to place  $k$  balls in  $n$  boxes. Let us consider three scenarios:

*Scenario 1:* Each box can contain at most one ball. For example, when  $n = 5$  and  $k = 2$ , there are 10 solutions:

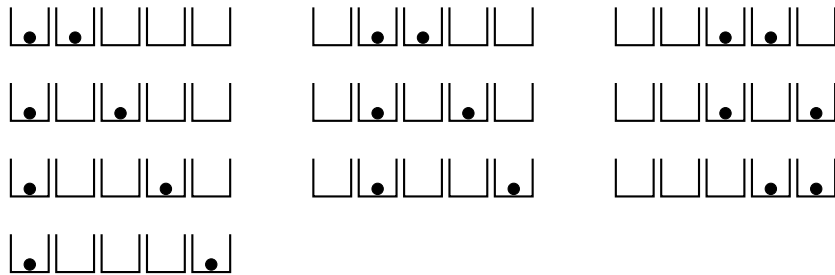

In this scenario, the answer is directly the binomial coefficient  $\binom{n}{k}$ .

*Scenario 2:* A box can contain multiple balls. For example, when  $n = 5$  and  $k = 2$ , there are 15 solutions:

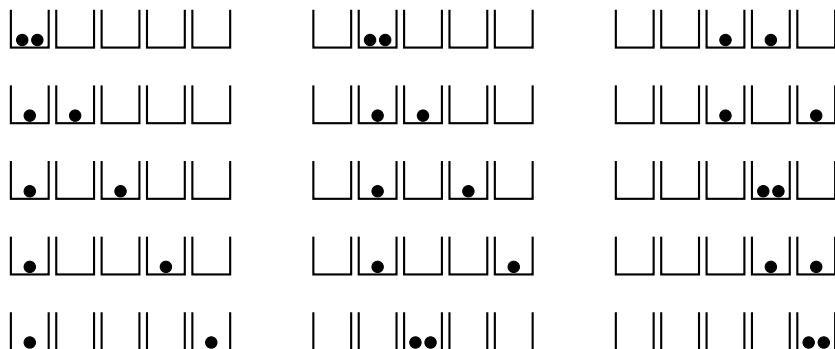

The process of placing the balls in the boxes can be represented as a string that consists of symbols "o" and "→". Initially, assume that we are standing at the leftmost box. The symbol "o" means that we place a ball in the current box, and the symbol "→" means that we move to the next box to the right.

Using this notation, each solution is a string that contains  $k$  times the symbol "o" and  $n - 1$  times the symbol "→". For example, the upper-right solution in the above picture corresponds to the string "→ → o → o →". Thus, the number of solutions is  $\binom{k+n-1}{k}$ .

*Scenario 3:* Each box may contain at most one ball, and in addition, no two adjacent boxes may both contain a ball. For example, when  $n = 5$  and  $k = 2$ , there are 6 solutions:

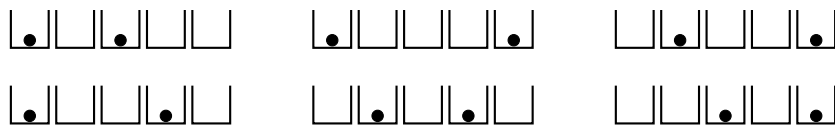

In this scenario, we can assume that  $k$  balls are initially placed in boxes and there is an empty box between each two adjacent boxes. The remaining task is to choose the positions for the remaining empty boxes. There are  $n - 2k + 1$  such boxes and  $k + 1$  positions for them. Thus, using the formula of scenario 2, the number of solutions is  $\binom{n-k+1}{n-2k+1}$ .

## Multinomial coefficients

The **multinomial coefficient**

$$\binom{n}{k_1, k_2, \dots, k_m} = \frac{n!}{k_1! k_2! \dots k_m!},$$

equals the number of ways we can divide  $n$  elements into subsets of sizes  $k_1, k_2, \dots, k_m$ , where  $k_1 + k_2 + \dots + k_m = n$ . Multinomial coefficients can be seen as a generalization of binomial coefficients; if  $m = 2$ , the above formula corresponds to the binomial coefficient formula.

## 22.2 Catalan numbers

The **Catalan number**  $C_n$  equals the number of valid parenthesis expressions that consist of  $n$  left parentheses and  $n$  right parentheses.

For example,  $C_3 = 5$ , because we can construct the following parenthesis expressions using three left and right parentheses:

- $()()()$
- $((()))$
- $()(())$
- $((())())$
- $(())()$

## Parenthesis expressions

What is exactly a *valid parenthesis expression*? The following rules precisely define all valid parenthesis expressions:

- An empty parenthesis expression is valid.
- If an expression  $A$  is valid, then also the expression  $(A)$  is valid.
- If expressions  $A$  and  $B$  are valid, then also the expression  $AB$  is valid.

Another way to characterize valid parenthesis expressions is that if we choose any prefix of such an expression, it has to contain at least as many left parentheses as right parentheses. In addition, the complete expression has to contain an equal number of left and right parentheses.

### Formula 1

Catalan numbers can be calculated using the formula

$$C_n = \sum_{i=0}^{n-1} C_i C_{n-i-1}.$$

The sum goes through the ways to divide the expression into two parts such that both parts are valid expressions and the first part is as short as possible but not empty. For any  $i$ , the first part contains  $i + 1$  pairs of parentheses and the number of expressions is the product of the following values:

- $C_i$ : the number of ways to construct an expression using the parentheses of the first part, not counting the outermost parentheses
- $C_{n-i-1}$ : the number of ways to construct an expression using the parentheses of the second part

The base case is  $C_0 = 1$ , because we can construct an empty parenthesis expression using zero pairs of parentheses.

### Formula 2

Catalan numbers can also be calculated using binomial coefficients:

$$C_n = \frac{1}{n+1} \binom{2n}{n}$$

The formula can be explained as follows:

There are a total of  $\binom{2n}{n}$  ways to construct a (not necessarily valid) parenthesis expression that contains  $n$  left parentheses and  $n$  right parentheses. Let us calculate the number of such expressions that are *not* valid.

If a parenthesis expression is not valid, it has to contain a prefix where the number of right parentheses exceeds the number of left parentheses. The

idea is to reverse each parenthesis that belongs to such a prefix. For example, the expression  $()()()$  contains a prefix  $()$ , and after reversing the prefix, the expression becomes  $)((($ .

The resulting expression consists of  $n + 1$  left parentheses and  $n - 1$  right parentheses. The number of such expressions is  $\binom{2n}{n+1}$ , which equals the number of non-valid parenthesis expressions. Thus, the number of valid parenthesis expressions can be calculated using the formula

$$\binom{2n}{n} - \binom{2n}{n+1} = \binom{2n}{n} - \frac{n}{n+1} \binom{2n}{n} = \frac{1}{n+1} \binom{2n}{n}.$$

## Counting trees

Catalan numbers are also related to trees:

- there are  $C_n$  binary trees of  $n$  nodes
- there are  $C_{n-1}$  rooted trees of  $n$  nodes

For example, for  $C_3 = 5$ , the binary trees are

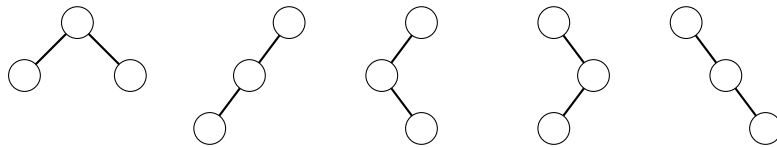

and the rooted trees are

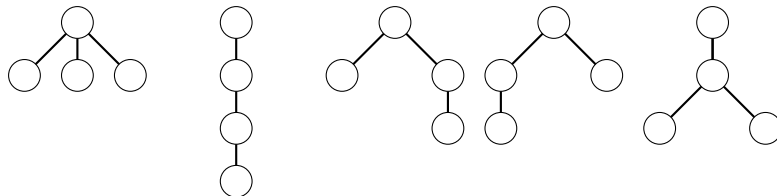

## 22.3 Inclusion-exclusion

**Inclusion-exclusion** is a technique that can be used for counting the size of a union of sets when the sizes of the intersections are known, and vice versa. A simple example of the technique is the formula

$$|A \cup B| = |A| + |B| - |A \cap B|,$$

where  $A$  and  $B$  are sets and  $|X|$  denotes the size of  $X$ . The formula can be illustrated as follows:

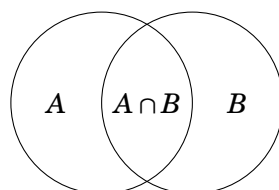

Our goal is to calculate the size of the union  $A \cup B$  that corresponds to the area of the region that belongs to at least one circle. The picture shows that we can calculate the area of  $A \cup B$  by first summing the areas of  $A$  and  $B$  and then subtracting the area of  $A \cap B$ .

The same idea can be applied when the number of sets is larger. When there are three sets, the inclusion-exclusion formula is

$$|A \cup B \cup C| = |A| + |B| + |C| - |A \cap B| - |A \cap C| - |B \cap C| + |A \cap B \cap C|$$

and the corresponding picture is

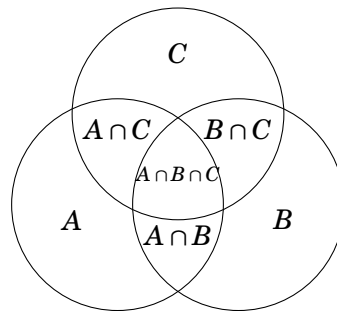

In the general case, the size of the union  $X_1 \cup X_2 \cup \dots \cup X_n$  can be calculated by going through all possible intersections that contain some of the sets  $X_1, X_2, \dots, X_n$ . If the intersection contains an odd number of sets, its size is added to the answer, and otherwise its size is subtracted from the answer.

Note that there are similar formulas for calculating the size of an intersection from the sizes of unions. For example,

$$|A \cap B| = |A| + |B| - |A \cup B|$$

and

$$|A \cap B \cap C| = |A| + |B| + |C| - |A \cup B| - |A \cup C| - |B \cup C| + |A \cup B \cup C|.$$

## Derangements

As an example, let us count the number of **derangements** of elements  $\{1, 2, \dots, n\}$ , i.e., permutations where no element remains in its original place. For example, when  $n = 3$ , there are two derangements:  $(2, 3, 1)$  and  $(3, 1, 2)$ .

One approach for solving the problem is to use inclusion-exclusion. Let  $X_k$  be the set of permutations that contain the element  $k$  at position  $k$ . For example, when  $n = 3$ , the sets are as follows:

$$\begin{aligned} X_1 &= \{(1, 2, 3), (1, 3, 2)\} \\ X_2 &= \{(1, 2, 3), (3, 2, 1)\} \\ X_3 &= \{(1, 2, 3), (2, 1, 3)\} \end{aligned}$$

Using these sets, the number of derangements equals

$$n! - |X_1 \cup X_2 \cup \dots \cup X_n|,$$

so it suffices to calculate the size of the union. Using inclusion-exclusion, this reduces to calculating sizes of intersections which can be done efficiently. For example, when  $n = 3$ , the size of  $|X_1 \cup X_2 \cup X_3|$  is

$$\begin{aligned} & |X_1| + |X_2| + |X_3| - |X_1 \cap X_2| - |X_1 \cap X_3| - |X_2 \cap X_3| + |X_1 \cap X_2 \cap X_3| \\ = & 2 + 2 + 2 - 1 - 1 - 1 + 1 \\ = & 4, \end{aligned}$$

so the number of solutions is  $3! - 4 = 2$ .

It turns out that the problem can also be solved without using inclusion-exclusion. Let  $f(n)$  denote the number of derangements for  $\{1, 2, \dots, n\}$ . We can use the following recursive formula:

$$f(n) = \begin{cases} 0 & n = 1 \\ 1 & n = 2 \\ (n-1)(f(n-2) + f(n-1)) & n > 2 \end{cases}$$

The formula can be derived by considering the possibilities how the element 1 changes in the derangement. There are  $n - 1$  ways to choose an element  $x$  that replaces the element 1. In each such choice, there are two options:

*Option 1:* We also replace the element  $x$  with the element 1. After this, the remaining task is to construct a derangement of  $n - 2$  elements.

*Option 2:* We replace the element  $x$  with some other element than 1. Now we have to construct a derangement of  $n - 1$  element, because we cannot replace the element  $x$  with the element 1, and all other elements must be changed.

## 22.4 Burnside's lemma

**Burnside's lemma** can be used to count the number of combinations so that only one representative is counted for each group of symmetric combinations. Burnside's lemma states that the number of combinations is

$$\sum_{k=1}^n \frac{c(k)}{n},$$

where there are  $n$  ways to change the position of a combination, and there are  $c(k)$  combinations that remain unchanged when the  $k$ th way is applied.

As an example, let us calculate the number of necklaces of  $n$  pearls, where each pearl has  $m$  possible colors. Two necklaces are symmetric if they are similar after rotating them. For example, the necklace

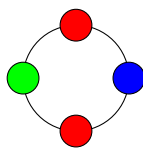

has the following symmetric necklaces:



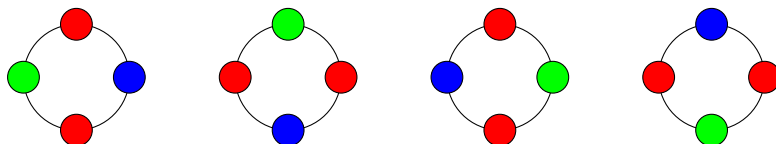

There are  $n$  ways to change the position of a necklace, because we can rotate it  $0, 1, \dots, n - 1$  steps clockwise. If the number of steps is 0, all  $m^n$  necklaces remain the same, and if the number of steps is 1, only the  $m$  necklaces where each pearl has the same color remain the same.

More generally, when the number of steps is  $k$ , a total of

$$m^{\gcd(k,n)}$$

necklaces remain the same, where  $\gcd(k, n)$  is the greatest common divisor of  $k$  and  $n$ . The reason for this is that blocks of pearls of size  $\gcd(k, n)$  will replace each other. Thus, according to Burnside's lemma, the number of necklaces is

$$\sum_{i=0}^{n-1} \frac{m^{\gcd(i,n)}}{n}.$$

For example, the number of necklaces of length 4 with 3 colors is

$$\frac{3^4 + 3 + 3^2 + 3}{4} = 24.$$

## 22.5 Cayley's formula

**Cayley's formula** states that there are  $n^{n-2}$  labeled trees that contain  $n$  nodes. The nodes are labeled  $1, 2, \dots, n$ , and two trees are different if either their structure or labeling is different.

For example, when  $n = 4$ , the number of labeled trees is  $4^{4-2} = 16$ :

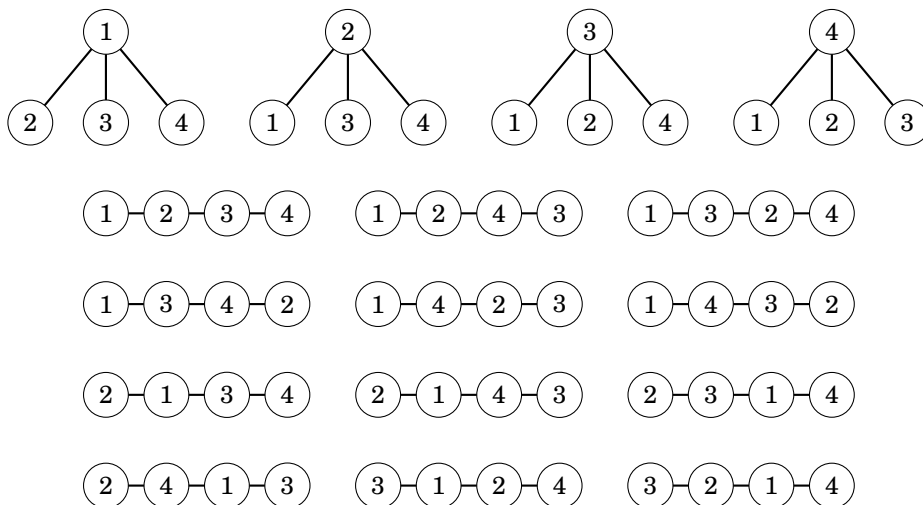

Next we will see how Cayley's formula can be derived using Prüfer codes.

## Prüfer code

A **Prüfer code** is a sequence of  $n - 2$  numbers that describes a labeled tree. The code is constructed by following a process that removes  $n - 2$  leaves from the tree. At each step, the leaf with the smallest label is removed, and the label of its only neighbor is added to the code.

For example, let us calculate the Prüfer code of the following graph:

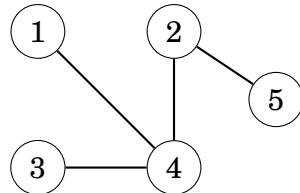

First we remove node 1 and add node 4 to the code:

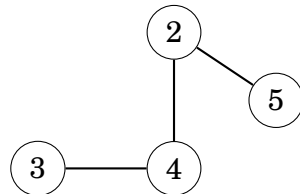

Then we remove node 3 and add node 4 to the code:

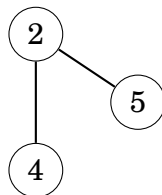

Finally we remove node 4 and add node 2 to the code:

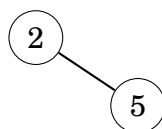

Thus, the Prüfer code of the graph is  $[4, 4, 2]$ .

We can construct a Prüfer code for any tree, and more importantly, the original tree can be reconstructed from a Prüfer code. Hence, the number of labeled trees of  $n$  nodes equals  $n^{n-2}$ , the number of Prüfer codes of size  $n$ .

# Chapter 23

## Matrices

A **matrix** is a mathematical concept that corresponds to a two-dimensional array in programming. For example,

$$A = \begin{bmatrix} 6 & 13 & 7 & 4 \\ 7 & 0 & 8 & 2 \\ 9 & 5 & 4 & 18 \end{bmatrix}$$

is a matrix of size  $3 \times 4$ , i.e., it has 3 rows and 4 columns. The notation  $[i, j]$  refers to the element in row  $i$  and column  $j$  in a matrix. For example, in the above matrix,  $A[2, 3] = 8$  and  $A[3, 1] = 9$ .

A special case of a matrix is a **vector** that is a one-dimensional matrix of size  $n \times 1$ . For example,

$$V = \begin{bmatrix} 4 \\ 7 \\ 5 \end{bmatrix}$$

is a vector that contains three elements.

The **transpose**  $A^T$  of a matrix  $A$  is obtained when the rows and columns of  $A$  are swapped, i.e.,  $A^T[i, j] = A[j, i]$ :

$$A^T = \begin{bmatrix} 6 & 7 & 9 \\ 13 & 0 & 5 \\ 7 & 8 & 4 \\ 4 & 2 & 18 \end{bmatrix}$$

A matrix is a **square matrix** if it has the same number of rows and columns. For example, the following matrix is a square matrix:

$$S = \begin{bmatrix} 3 & 12 & 4 \\ 5 & 9 & 15 \\ 0 & 2 & 4 \end{bmatrix}$$

### 23.1 Operations

The sum  $A + B$  of matrices  $A$  and  $B$  is defined if the matrices are of the same size. The result is a matrix where each element is the sum of the corresponding elements in  $A$  and  $B$ .

For example,

$$\begin{bmatrix} 6 & 1 & 4 \\ 3 & 9 & 2 \end{bmatrix} + \begin{bmatrix} 4 & 9 & 3 \\ 8 & 1 & 3 \end{bmatrix} = \begin{bmatrix} 6+4 & 1+9 & 4+3 \\ 3+8 & 9+1 & 2+3 \end{bmatrix} = \begin{bmatrix} 10 & 10 & 7 \\ 11 & 10 & 5 \end{bmatrix}.$$

Multiplying a matrix  $A$  by a value  $x$  means that each element of  $A$  is multiplied by  $x$ . For example,

$$2 \cdot \begin{bmatrix} 6 & 1 & 4 \\ 3 & 9 & 2 \end{bmatrix} = \begin{bmatrix} 2 \cdot 6 & 2 \cdot 1 & 2 \cdot 4 \\ 2 \cdot 3 & 2 \cdot 9 & 2 \cdot 2 \end{bmatrix} = \begin{bmatrix} 12 & 2 & 8 \\ 6 & 18 & 4 \end{bmatrix}.$$

## Matrix multiplication

The product  $AB$  of matrices  $A$  and  $B$  is defined if  $A$  is of size  $a \times n$  and  $B$  is of size  $n \times b$ , i.e., the width of  $A$  equals the height of  $B$ . The result is a matrix of size  $a \times b$  whose elements are calculated using the formula

$$AB[i,j] = \sum_{k=1}^n A[i,k] \cdot B[k,j].$$

The idea is that each element of  $AB$  is a sum of products of elements of  $A$  and  $B$  according to the following picture:

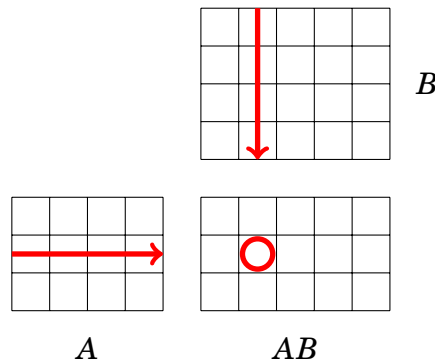

For example,

$$\begin{bmatrix} 1 & 4 \\ 3 & 9 \\ 8 & 6 \end{bmatrix} \cdot \begin{bmatrix} 1 & 6 \\ 2 & 9 \end{bmatrix} = \begin{bmatrix} 1 \cdot 1 + 4 \cdot 2 & 1 \cdot 6 + 4 \cdot 9 \\ 3 \cdot 1 + 9 \cdot 2 & 3 \cdot 6 + 9 \cdot 9 \\ 8 \cdot 1 + 6 \cdot 2 & 8 \cdot 6 + 6 \cdot 9 \end{bmatrix} = \begin{bmatrix} 9 & 42 \\ 21 & 99 \\ 20 & 102 \end{bmatrix}.$$

Matrix multiplication is associative, so  $A(BC) = (AB)C$  holds, but it is not commutative, so  $AB = BA$  does not usually hold.

An **identity matrix** is a square matrix where each element on the diagonal is 1 and all other elements are 0. For example, the following matrix is the  $3 \times 3$  identity matrix:

$$I = \begin{bmatrix} 1 & 0 & 0 \\ 0 & 1 & 0 \\ 0 & 0 & 1 \end{bmatrix}$$

Multiplying a matrix by an identity matrix does not change it. For example,

$$\begin{bmatrix} 1 & 0 & 0 \\ 0 & 1 & 0 \\ 0 & 0 & 1 \end{bmatrix} \cdot \begin{bmatrix} 1 & 4 \\ 3 & 9 \\ 8 & 6 \end{bmatrix} = \begin{bmatrix} 1 & 4 \\ 3 & 9 \\ 8 & 6 \end{bmatrix} \quad \text{and} \quad \begin{bmatrix} 1 & 4 \\ 3 & 9 \\ 8 & 6 \end{bmatrix} \cdot \begin{bmatrix} 1 & 0 \\ 0 & 1 \end{bmatrix} = \begin{bmatrix} 1 & 4 \\ 3 & 9 \\ 8 & 6 \end{bmatrix}.$$

Using a straightforward algorithm, we can calculate the product of two  $n \times n$  matrices in  $O(n^3)$  time. There are also more efficient algorithms for matrix multiplication<sup>1</sup>, but they are mostly of theoretical interest and such algorithms are not necessary in competitive programming.

## Matrix power

The power  $A^k$  of a matrix  $A$  is defined if  $A$  is a square matrix. The definition is based on matrix multiplication:

$$A^k = \underbrace{A \cdot A \cdot A \cdots A}_{k \text{ times}}$$

For example,

$$\begin{bmatrix} 2 & 5 \\ 1 & 4 \end{bmatrix}^3 = \begin{bmatrix} 2 & 5 \\ 1 & 4 \end{bmatrix} \cdot \begin{bmatrix} 2 & 5 \\ 1 & 4 \end{bmatrix} \cdot \begin{bmatrix} 2 & 5 \\ 1 & 4 \end{bmatrix} = \begin{bmatrix} 48 & 165 \\ 33 & 114 \end{bmatrix}.$$

In addition,  $A^0$  is an identity matrix. For example,

$$\begin{bmatrix} 2 & 5 \\ 1 & 4 \end{bmatrix}^0 = \begin{bmatrix} 1 & 0 \\ 0 & 1 \end{bmatrix}.$$

The matrix  $A^k$  can be efficiently calculated in  $O(n^3 \log k)$  time using the algorithm in Chapter 21.2. For example,

$$\begin{bmatrix} 2 & 5 \\ 1 & 4 \end{bmatrix}^8 = \begin{bmatrix} 2 & 5 \\ 1 & 4 \end{bmatrix}^4 \cdot \begin{bmatrix} 2 & 5 \\ 1 & 4 \end{bmatrix}^4.$$

## Determinant

The **determinant**  $\det(A)$  of a matrix  $A$  is defined if  $A$  is a square matrix. If  $A$  is of size  $1 \times 1$ , then  $\det(A) = A[1, 1]$ . The determinant of a larger matrix is calculated recursively using the formula

$$\det(A) = \sum_{j=1}^n A[1, j]C[1, j],$$

where  $C[i, j]$  is the **cofactor** of  $A$  at  $[i, j]$ . The cofactor is calculated using the formula

$$C[i, j] = (-1)^{i+j} \det(M[i, j]),$$

<sup>1</sup>The first such algorithm was Strassen's algorithm, published in 1969 [63], whose time complexity is  $O(n^{2.80735})$ ; the best current algorithm [27] works in  $O(n^{2.37286})$  time.

where  $M[i, j]$  is obtained by removing row  $i$  and column  $j$  from  $A$ . Due to the coefficient  $(-1)^{i+j}$  in the cofactor, every other determinant is positive and negative. For example,

$$\det\begin{pmatrix} 3 & 4 \\ 1 & 6 \end{pmatrix} = 3 \cdot 6 - 4 \cdot 1 = 14$$

and

$$\det\begin{pmatrix} 2 & 4 & 3 \\ 5 & 1 & 6 \\ 7 & 2 & 4 \end{pmatrix} = 2 \cdot \det\begin{pmatrix} 1 & 6 \\ 2 & 4 \end{pmatrix} - 4 \cdot \det\begin{pmatrix} 5 & 6 \\ 7 & 4 \end{pmatrix} + 3 \cdot \det\begin{pmatrix} 5 & 1 \\ 7 & 2 \end{pmatrix} = 81.$$

The determinant of  $A$  tells us whether there is an **inverse matrix**  $A^{-1}$  such that  $A \cdot A^{-1} = I$ , where  $I$  is an identity matrix. It turns out that  $A^{-1}$  exists exactly when  $\det(A) \neq 0$ , and it can be calculated using the formula

$$A^{-1}[i, j] = \frac{C[j, i]}{\det(A)}.$$

For example,

$$\underbrace{\begin{bmatrix} 2 & 4 & 3 \\ 5 & 1 & 6 \\ 7 & 2 & 4 \end{bmatrix}}_A \cdot \underbrace{\frac{1}{81} \begin{bmatrix} -8 & -10 & 21 \\ 22 & -13 & 3 \\ 3 & 24 & -18 \end{bmatrix}}_{A^{-1}} = \underbrace{\begin{bmatrix} 1 & 0 & 0 \\ 0 & 1 & 0 \\ 0 & 0 & 1 \end{bmatrix}}_I.$$

## 23.2 Linear recurrences

A **linear recurrence** is a function  $f(n)$  whose initial values are  $f(0), f(1), \dots, f(k-1)$  and larger values are calculated recursively using the formula

$$f(n) = c_1 f(n-1) + c_2 f(n-2) + \dots + c_k f(n-k),$$

where  $c_1, c_2, \dots, c_k$  are constant coefficients.

Dynamic programming can be used to calculate any value of  $f(n)$  in  $O(kn)$  time by calculating all values of  $f(0), f(1), \dots, f(n)$  one after another. However, if  $k$  is small, it is possible to calculate  $f(n)$  much more efficiently in  $O(k^3 \log n)$  time using matrix operations.

### Fibonacci numbers

A simple example of a linear recurrence is the following function that defines the Fibonacci numbers:

$$\begin{aligned} f(0) &= 0 \\ f(1) &= 1 \\ f(n) &= f(n-1) + f(n-2) \end{aligned}$$

In this case,  $k = 2$  and  $c_1 = c_2 = 1$ .

To efficiently calculate Fibonacci numbers, we represent the Fibonacci formula as a square matrix  $X$  of size  $2 \times 2$ , for which the following holds:

$$X \cdot \begin{bmatrix} f(i) \\ f(i+1) \end{bmatrix} = \begin{bmatrix} f(i+1) \\ f(i+2) \end{bmatrix}$$

Thus, values  $f(i)$  and  $f(i+1)$  are given as "input" for  $X$ , and  $X$  calculates values  $f(i+1)$  and  $f(i+2)$  from them. It turns out that such a matrix is

$$X = \begin{bmatrix} 0 & 1 \\ 1 & 1 \end{bmatrix}.$$

For example,

$$\begin{bmatrix} 0 & 1 \\ 1 & 1 \end{bmatrix} \cdot \begin{bmatrix} f(5) \\ f(6) \end{bmatrix} = \begin{bmatrix} 0 & 1 \\ 1 & 1 \end{bmatrix} \cdot \begin{bmatrix} 5 \\ 8 \end{bmatrix} = \begin{bmatrix} 8 \\ 13 \end{bmatrix} = \begin{bmatrix} f(6) \\ f(7) \end{bmatrix}.$$

Thus, we can calculate  $f(n)$  using the formula

$$\begin{bmatrix} f(n) \\ f(n+1) \end{bmatrix} = X^n \cdot \begin{bmatrix} f(0) \\ f(1) \end{bmatrix} = \begin{bmatrix} 0 & 1 \\ 1 & 1 \end{bmatrix}^n \cdot \begin{bmatrix} 0 \\ 1 \end{bmatrix}.$$

The value of  $X^n$  can be calculated in  $O(\log n)$  time, so the value of  $f(n)$  can also be calculated in  $O(\log n)$  time.

## General case

Let us now consider the general case where  $f(n)$  is any linear recurrence. Again, our goal is to construct a matrix  $X$  for which

$$X \cdot \begin{bmatrix} f(i) \\ f(i+1) \\ \vdots \\ f(i+k-1) \end{bmatrix} = \begin{bmatrix} f(i+1) \\ f(i+2) \\ \vdots \\ f(i+k) \end{bmatrix}.$$

Such a matrix is

$$X = \begin{bmatrix} 0 & 1 & 0 & 0 & \cdots & 0 \\ 0 & 0 & 1 & 0 & \cdots & 0 \\ 0 & 0 & 0 & 1 & \cdots & 0 \\ \vdots & \vdots & \vdots & \vdots & \ddots & \vdots \\ 0 & 0 & 0 & 0 & \cdots & 1 \\ c_k & c_{k-1} & c_{k-2} & c_{k-3} & \cdots & c_1 \end{bmatrix}.$$

In the first  $k-1$  rows, each element is 0 except that one element is 1. These rows replace  $f(i)$  with  $f(i+1)$ ,  $f(i+1)$  with  $f(i+2)$ , and so on. The last row contains the coefficients of the recurrence to calculate the new value  $f(i+k)$ .

Now,  $f(n)$  can be calculated in  $O(k^3 \log n)$  time using the formula

$$\begin{bmatrix} f(n) \\ f(n+1) \\ \vdots \\ f(n+k-1) \end{bmatrix} = X^n \cdot \begin{bmatrix} f(0) \\ f(1) \\ \vdots \\ f(k-1) \end{bmatrix}.$$

## 23.3 Graphs and matrices

### Counting paths

The powers of an adjacency matrix of a graph have an interesting property. When  $V$  is an adjacency matrix of an unweighted graph, the matrix  $V^n$  contains the numbers of paths of  $n$  edges between the nodes in the graph.

For example, for the graph

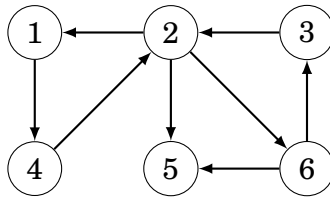

the adjacency matrix is

$$V = \begin{bmatrix} 0 & 0 & 0 & 1 & 0 & 0 \\ 1 & 0 & 0 & 0 & 1 & 1 \\ 0 & 1 & 0 & 0 & 0 & 0 \\ 0 & 1 & 0 & 0 & 0 & 0 \\ 0 & 0 & 0 & 0 & 0 & 0 \\ 0 & 0 & 1 & 0 & 1 & 0 \end{bmatrix}.$$

Now, for example, the matrix

$$V^4 = \begin{bmatrix} 0 & 0 & 1 & 1 & 1 & 0 \\ 2 & 0 & 0 & 0 & 2 & 2 \\ 0 & 2 & 0 & 0 & 0 & 0 \\ 0 & 2 & 0 & 0 & 0 & 0 \\ 0 & 0 & 0 & 0 & 0 & 0 \\ 0 & 0 & 1 & 1 & 1 & 0 \end{bmatrix}$$

contains the numbers of paths of 4 edges between the nodes. For example,  $V^4[2,5] = 2$ , because there are two paths of 4 edges from node 2 to node 5:  $2 \rightarrow 1 \rightarrow 4 \rightarrow 2 \rightarrow 5$  and  $2 \rightarrow 6 \rightarrow 3 \rightarrow 2 \rightarrow 5$ .

### Shortest paths

Using a similar idea in a weighted graph, we can calculate for each pair of nodes the minimum length of a path between them that contains exactly  $n$  edges. To calculate this, we have to define matrix multiplication in a new way, so that we do not calculate the numbers of paths but minimize the lengths of paths.



As an example, consider the following graph:

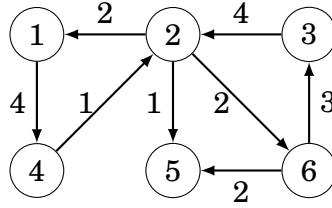

Let us construct an adjacency matrix where  $\infty$  means that an edge does not exist, and other values correspond to edge weights. The matrix is

$$V = \begin{bmatrix} \infty & \infty & \infty & 4 & \infty & \infty \\ 2 & \infty & \infty & \infty & 1 & 2 \\ \infty & 4 & \infty & \infty & \infty & \infty \\ \infty & 1 & \infty & \infty & \infty & \infty \\ \infty & \infty & \infty & \infty & \infty & \infty \\ \infty & \infty & 3 & \infty & 2 & \infty \end{bmatrix}.$$

Instead of the formula

$$AB[i, j] = \sum_{k=1}^n A[i, k] \cdot B[k, j]$$

we now use the formula

$$AB[i, j] = \min_{k=1}^n A[i, k] + B[k, j]$$

for matrix multiplication, so we calculate a minimum instead of a sum, and a sum of elements instead of a product. After this modification, matrix powers correspond to shortest paths in the graph.

For example, as

$$V^4 = \begin{bmatrix} \infty & \infty & 10 & 11 & 9 & \infty \\ 9 & \infty & \infty & \infty & 8 & 9 \\ \infty & 11 & \infty & \infty & \infty & \infty \\ \infty & 8 & \infty & \infty & \infty & \infty \\ \infty & \infty & \infty & \infty & \infty & \infty \\ \infty & \infty & 12 & 13 & 11 & \infty \end{bmatrix},$$

we can conclude that the minimum length of a path of 4 edges from node 2 to node 5 is 8. Such a path is  $2 \rightarrow 1 \rightarrow 4 \rightarrow 2 \rightarrow 5$ .

## Kirchhoff's theorem

**Kirchhoff's theorem** provides a way to calculate the number of spanning trees of a graph as a determinant of a special matrix. For example, the graph

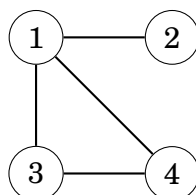

has three spanning trees:

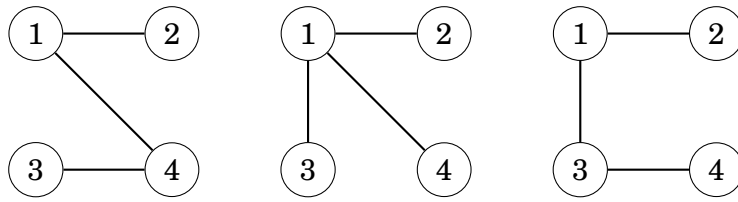

To calculate the number of spanning trees, we construct a **Laplacian matrix**  $L$ , where  $L[i, i]$  is the degree of node  $i$  and  $L[i, j] = -1$  if there is an edge between nodes  $i$  and  $j$ , and otherwise  $L[i, j] = 0$ . The Laplacean matrix for the above graph is as follows:

$$L = \begin{bmatrix} 3 & -1 & -1 & -1 \\ -1 & 1 & 0 & 0 \\ -1 & 0 & 2 & -1 \\ -1 & 0 & -1 & 2 \end{bmatrix}$$

It can be shown that the number of spanning trees equals the determinant of a matrix that is obtained when we remove any row and any column from  $L$ . For example, if we remove the first row and column, the result is

$$\det \begin{pmatrix} 1 & 0 & 0 \\ 0 & 2 & -1 \\ 0 & -1 & 2 \end{pmatrix} = 3.$$

The determinant is always the same, regardless of which row and column we remove from  $L$ .

Note that Cayley's formula in Chapter 22.5 is a special case of Kirchhoff's theorem, because in a complete graph of  $n$  nodes

$$\det \begin{pmatrix} n-1 & -1 & \cdots & -1 \\ -1 & n-1 & \cdots & -1 \\ \vdots & \vdots & \ddots & \vdots \\ -1 & -1 & \cdots & n-1 \end{pmatrix} = n^{n-2}.$$

# Chapter 24

## Probability

A **probability** is a real number between 0 and 1 that indicates how probable an event is. If an event is certain to happen, its probability is 1, and if an event is impossible, its probability is 0. The probability of an event is denoted  $P(\dots)$  where the three dots describe the event.

For example, when throwing a dice, the outcome is an integer between 1 and 6, and the probability of each outcome is  $1/6$ . For example, we can calculate the following probabilities:

- $P(\text{"the outcome is 4"}) = 1/6$
- $P(\text{"the outcome is not 6"}) = 5/6$
- $P(\text{"the outcome is even"}) = 1/2$

### 24.1 Calculation

To calculate the probability of an event, we can either use combinatorics or simulate the process that generates the event. As an example, let us calculate the probability of drawing three cards with the same value from a shuffled deck of cards (for example,  $\spadesuit 8$ ,  $\clubsuit 8$  and  $\diamond 8$ ).

#### Method 1

We can calculate the probability using the formula

$$\frac{\text{number of desired outcomes}}{\text{total number of outcomes}}.$$

In this problem, the desired outcomes are those in which the value of each card is the same. There are  $13 \binom{4}{3}$  such outcomes, because there are 13 possibilities for the value of the cards and  $\binom{4}{3}$  ways to choose 3 suits from 4 possible suits.

There are a total of  $\binom{52}{3}$  outcomes, because we choose 3 cards from 52 cards. Thus, the probability of the event is

$$\frac{13 \binom{4}{3}}{\binom{52}{3}} = \frac{1}{425}.$$

## Method 2

Another way to calculate the probability is to simulate the process that generates the event. In this example, we draw three cards, so the process consists of three steps. We require that each step of the process is successful.

Drawing the first card certainly succeeds, because there are no restrictions. The second step succeeds with probability  $3/51$ , because there are 51 cards left and 3 of them have the same value as the first card. In a similar way, the third step succeeds with probability  $2/50$ .

The probability that the entire process succeeds is

$$1 \cdot \frac{3}{51} \cdot \frac{2}{50} = \frac{1}{425}.$$

## 24.2 Events

An event in probability theory can be represented as a set

$$A \subset X,$$

where  $X$  contains all possible outcomes and  $A$  is a subset of outcomes. For example, when drawing a dice, the outcomes are

$$X = \{1, 2, 3, 4, 5, 6\}.$$

Now, for example, the event "the outcome is even" corresponds to the set

$$A = \{2, 4, 6\}.$$

Each outcome  $x$  is assigned a probability  $p(x)$ . Then, the probability  $P(A)$  of an event  $A$  can be calculated as a sum of probabilities of outcomes using the formula

$$P(A) = \sum_{x \in A} p(x).$$

For example, when throwing a dice,  $p(x) = 1/6$  for each outcome  $x$ , so the probability of the event "the outcome is even" is

$$p(2) + p(4) + p(6) = 1/2.$$

The total probability of the outcomes in  $X$  must be 1, i.e.,  $P(X) = 1$ .

Since the events in probability theory are sets, we can manipulate them using standard set operations:

- The **complement**  $\bar{A}$  means "A does not happen". For example, when throwing a dice, the complement of  $A = \{2, 4, 6\}$  is  $\bar{A} = \{1, 3, 5\}$ .
- The **union**  $A \cup B$  means "A or B happen". For example, the union of  $A = \{2, 5\}$  and  $B = \{4, 5, 6\}$  is  $A \cup B = \{2, 4, 5, 6\}$ .
- The **intersection**  $A \cap B$  means "A and B happen". For example, the intersection of  $A = \{2, 5\}$  and  $B = \{4, 5, 6\}$  is  $A \cap B = \{5\}$ .

## Complement

The probability of the complement  $\bar{A}$  is calculated using the formula

$$P(\bar{A}) = 1 - P(A).$$

Sometimes, we can solve a problem easily using complements by solving the opposite problem. For example, the probability of getting at least one six when throwing a dice ten times is

$$1 - (5/6)^{10}.$$

Here  $5/6$  is the probability that the outcome of a single throw is not six, and  $(5/6)^{10}$  is the probability that none of the ten throws is a six. The complement of this is the answer to the problem.

## Union

The probability of the union  $A \cup B$  is calculated using the formula

$$P(A \cup B) = P(A) + P(B) - P(A \cap B).$$

For example, when throwing a dice, the union of the events

$$A = \text{"the outcome is even"}$$

and

$$B = \text{"the outcome is less than 4"}$$

is

$$A \cup B = \text{"the outcome is even or less than 4"},$$

and its probability is

$$P(A \cup B) = P(A) + P(B) - P(A \cap B) = 1/2 + 1/2 - 1/6 = 5/6.$$

If the events  $A$  and  $B$  are **disjoint**, i.e.,  $A \cap B$  is empty, the probability of the event  $A \cup B$  is simply

$$P(A \cup B) = P(A) + P(B).$$

## Conditional probability

The **conditional probability**

$$P(A|B) = \frac{P(A \cap B)}{P(B)}$$

is the probability of  $A$  assuming that  $B$  happens. Hence, when calculating the probability of  $A$ , we only consider the outcomes that also belong to  $B$ .

Using the previous sets,

$$P(A|B) = 1/3,$$

because the outcomes of  $B$  are  $\{1, 2, 3\}$ , and one of them is even. This is the probability of an even outcome if we know that the outcome is between  $1 \dots 3$ .

## Intersection

Using conditional probability, the probability of the intersection  $A \cap B$  can be calculated using the formula

$$P(A \cap B) = P(A)P(B|A).$$

Events  $A$  and  $B$  are **independent** if

$$P(A|B) = P(A) \quad \text{and} \quad P(B|A) = P(B),$$

which means that the fact that  $B$  happens does not change the probability of  $A$ , and vice versa. In this case, the probability of the intersection is

$$P(A \cap B) = P(A)P(B).$$

For example, when drawing a card from a deck, the events

$A =$  "the suit is clubs"

and

$B =$  "the value is four"

are independent. Hence the event

$A \cap B =$  "the card is the four of clubs"

happens with probability

$$P(A \cap B) = P(A)P(B) = 1/4 \cdot 1/13 = 1/52.$$

## 24.3 Random variables

A **random variable** is a value that is generated by a random process. For example, when throwing two dice, a possible random variable is

$X =$  "the sum of the outcomes".

For example, if the outcomes are  $[4, 6]$  (meaning that we first throw a four and then a six), then the value of  $X$  is 10.

We denote  $P(X = x)$  the probability that the value of a random variable  $X$  is  $x$ . For example, when throwing two dice,  $P(X = 10) = 3/36$ , because the total number of outcomes is 36 and there are three possible ways to obtain the sum 10:  $[4, 6]$ ,  $[5, 5]$  and  $[6, 4]$ .

## Expected value

The **expected value**  $E[X]$  indicates the average value of a random variable  $X$ . The expected value can be calculated as the sum

$$\sum_x P(X = x)x,$$

where  $x$  goes through all possible values of  $X$ .

For example, when throwing a dice, the expected outcome is

$$1/6 \cdot 1 + 1/6 \cdot 2 + 1/6 \cdot 3 + 1/6 \cdot 4 + 1/6 \cdot 5 + 1/6 \cdot 6 = 7/2.$$

A useful property of expected values is **linearity**. It means that the sum  $E[X_1 + X_2 + \dots + X_n]$  always equals the sum  $E[X_1] + E[X_2] + \dots + E[X_n]$ . This formula holds even if random variables depend on each other.

For example, when throwing two dice, the expected sum is

$$E[X_1 + X_2] = E[X_1] + E[X_2] = 7/2 + 7/2 = 7.$$

Let us now consider a problem where  $n$  balls are randomly placed in  $n$  boxes, and our task is to calculate the expected number of empty boxes. Each ball has an equal probability to be placed in any of the boxes. For example, if  $n = 2$ , the possibilities are as follows:



In this case, the expected number of empty boxes is

$$\frac{0 + 0 + 1 + 1}{4} = \frac{1}{2}.$$

In the general case, the probability that a single box is empty is

$$\left(\frac{n-1}{n}\right)^n,$$

because no ball should be placed in it. Hence, using linearity, the expected number of empty boxes is

$$n \cdot \left(\frac{n-1}{n}\right)^n.$$

## Distributions

The **distribution** of a random variable  $X$  shows the probability of each value that  $X$  may have. The distribution consists of values  $P(X = x)$ . For example, when throwing two dice, the distribution for their sum is:

|            |      |      |      |      |      |      |      |      |      |      |      |
|------------|------|------|------|------|------|------|------|------|------|------|------|
| $x$        | 2    | 3    | 4    | 5    | 6    | 7    | 8    | 9    | 10   | 11   | 12   |
| $P(X = x)$ | 1/36 | 2/36 | 3/36 | 4/36 | 5/36 | 6/36 | 5/36 | 4/36 | 3/36 | 2/36 | 1/36 |

In a **uniform distribution**, the random variable  $X$  has  $n$  possible values  $a, a + 1, \dots, b$  and the probability of each value is  $1/n$ . For example, when throwing a dice,  $a = 1$ ,  $b = 6$  and  $P(X = x) = 1/6$  for each value  $x$ .

The expected value of  $X$  in a uniform distribution is

$$E[X] = \frac{a + b}{2}.$$

In a **binomial distribution**,  $n$  attempts are made and the probability that a single attempt succeeds is  $p$ . The random variable  $X$  counts the number of successful attempts, and the probability of a value  $x$  is

$$P(X = x) = p^x(1 - p)^{n-x} \binom{n}{x},$$

where  $p^x$  and  $(1 - p)^{n-x}$  correspond to successful and unsuccessful attempts, and  $\binom{n}{x}$  is the number of ways we can choose the order of the attempts.

For example, when throwing a dice ten times, the probability of throwing a six exactly three times is  $(1/6)^3(5/6)^7 \binom{10}{3}$ .

The expected value of  $X$  in a binomial distribution is

$$E[X] = pn.$$

In a **geometric distribution**, the probability that an attempt succeeds is  $p$ , and we continue until the first success happens. The random variable  $X$  counts the number of attempts needed, and the probability of a value  $x$  is

$$P(X = x) = (1 - p)^{x-1}p,$$

where  $(1 - p)^{x-1}$  corresponds to the unsuccessful attempts and  $p$  corresponds to the first successful attempt.

For example, if we throw a dice until we throw a six, the probability that the number of throws is exactly 4 is  $(5/6)^3 1/6$ .

The expected value of  $X$  in a geometric distribution is

$$E[X] = \frac{1}{p}.$$

## 24.4 Markov chains

A **Markov chain** is a random process that consists of states and transitions between them. For each state, we know the probabilities for moving to other states. A Markov chain can be represented as a graph whose nodes are states and edges are transitions.

As an example, consider a problem where we are in floor 1 in an  $n$  floor building. At each step, we randomly walk either one floor up or one floor down, except that we always walk one floor up from floor 1 and one floor down from floor  $n$ . What is the probability of being in floor  $m$  after  $k$  steps?

In this problem, each floor of the building corresponds to a state in a Markov chain. For example, if  $n = 5$ , the graph is as follows:



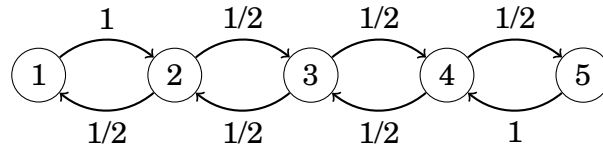

The probability distribution of a Markov chain is a vector  $[p_1, p_2, \dots, p_n]$ , where  $p_k$  is the probability that the current state is  $k$ . The formula  $p_1 + p_2 + \dots + p_n = 1$  always holds.

In the above scenario, the initial distribution is  $[1, 0, 0, 0, 0]$ , because we always begin in floor 1. The next distribution is  $[0, 1, 0, 0, 0]$ , because we can only move from floor 1 to floor 2. After this, we can either move one floor up or one floor down, so the next distribution is  $[1/2, 0, 1/2, 0, 0]$ , and so on.

An efficient way to simulate the walk in a Markov chain is to use dynamic programming. The idea is to maintain the probability distribution, and at each step go through all possibilities how we can move. Using this method, we can simulate a walk of  $m$  steps in  $O(n^2m)$  time.

The transitions of a Markov chain can also be represented as a matrix that updates the probability distribution. In the above scenario, the matrix is

$$\begin{bmatrix} 0 & 1/2 & 0 & 0 & 0 \\ 1 & 0 & 1/2 & 0 & 0 \\ 0 & 1/2 & 0 & 1/2 & 0 \\ 0 & 0 & 1/2 & 0 & 1 \\ 0 & 0 & 0 & 1/2 & 0 \end{bmatrix}.$$

When we multiply a probability distribution by this matrix, we get the new distribution after moving one step. For example, we can move from the distribution  $[1, 0, 0, 0, 0]$  to the distribution  $[0, 1, 0, 0, 0]$  as follows:

$$\begin{bmatrix} 0 & 1/2 & 0 & 0 & 0 \\ 1 & 0 & 1/2 & 0 & 0 \\ 0 & 1/2 & 0 & 1/2 & 0 \\ 0 & 0 & 1/2 & 0 & 1 \\ 0 & 0 & 0 & 1/2 & 0 \end{bmatrix} \begin{bmatrix} 1 \\ 0 \\ 0 \\ 0 \\ 0 \end{bmatrix} = \begin{bmatrix} 0 \\ 1 \\ 0 \\ 0 \\ 0 \end{bmatrix}.$$

By calculating matrix powers efficiently, we can calculate the distribution after  $m$  steps in  $O(n^3 \log m)$  time.

## 24.5 Randomized algorithms

Sometimes we can use randomness for solving a problem, even if the problem is not related to probabilities. A **randomized algorithm** is an algorithm that is based on randomness.

A **Monte Carlo algorithm** is a randomized algorithm that may sometimes give a wrong answer. For such an algorithm to be useful, the probability of a wrong answer should be small.

A **Las Vegas algorithm** is a randomized algorithm that always gives the correct answer, but its running time varies randomly. The goal is to design an algorithm that is efficient with high probability.

Next we will go through three example problems that can be solved using randomness.

## Order statistics

The  $k$ th **order statistic** of an array is the element at position  $k$  after sorting the array in increasing order. It is easy to calculate any order statistic in  $O(n \log n)$  time by first sorting the array, but is it really needed to sort the entire array just to find one element?

It turns out that we can find order statistics using a randomized algorithm without sorting the array. The algorithm, called **quickselect**<sup>1</sup>, is a Las Vegas algorithm: its running time is usually  $O(n)$  but  $O(n^2)$  in the worst case.

The algorithm chooses a random element  $x$  of the array, and moves elements smaller than  $x$  to the left part of the array, and all other elements to the right part of the array. This takes  $O(n)$  time when there are  $n$  elements. Assume that the left part contains  $a$  elements and the right part contains  $b$  elements. If  $a = k$ , element  $x$  is the  $k$ th order statistic. Otherwise, if  $a > k$ , we recursively find the  $k$ th order statistic for the left part, and if  $a < k$ , we recursively find the  $r$ th order statistic for the right part where  $r = k - a$ . The search continues in a similar way, until the element has been found.

When each element  $x$  is randomly chosen, the size of the array about halves at each step, so the time complexity for finding the  $k$ th order statistic is about

$$n + n/2 + n/4 + n/8 + \dots < 2n = O(n).$$

The worst case of the algorithm requires still  $O(n^2)$  time, because it is possible that  $x$  is always chosen in such a way that it is one of the smallest or largest elements in the array and  $O(n)$  steps are needed. However, the probability for this is so small that this never happens in practice.

## Verifying matrix multiplication

Our next problem is to *verify* if  $AB = C$  holds when  $A$ ,  $B$  and  $C$  are matrices of size  $n \times n$ . Of course, we can solve the problem by calculating the product  $AB$  again (in  $O(n^3)$  time using the basic algorithm), but one could hope that verifying the answer would be easier than to calculate it from scratch.

It turns out that we can solve the problem using a Monte Carlo algorithm<sup>2</sup> whose time complexity is only  $O(n^2)$ . The idea is simple: we choose a random vector  $X$  of  $n$  elements, and calculate the matrices  $ABX$  and  $CX$ . If  $ABX = CX$ , we report that  $AB = C$ , and otherwise we report that  $AB \neq C$ .

---

<sup>1</sup>In 1961, C. A. R. Hoare published two algorithms that are efficient on average: **quicksort** [36] for sorting arrays and **quickselect** [37] for finding order statistics.

<sup>2</sup>R. M. Freivalds published this algorithm in 1977 [26], and it is sometimes called **Freivalds' algorithm**.

The time complexity of the algorithm is  $O(n^2)$ , because we can calculate the matrices  $ABX$  and  $CX$  in  $O(n^2)$  time. We can calculate the matrix  $ABX$  efficiently by using the representation  $A(BX)$ , so only two multiplications of  $n \times n$  and  $n \times 1$  size matrices are needed.

The drawback of the algorithm is that there is a small chance that the algorithm makes a mistake when it reports that  $AB = C$ . For example,

$$\begin{bmatrix} 6 & 8 \\ 1 & 3 \end{bmatrix} \neq \begin{bmatrix} 8 & 7 \\ 3 & 2 \end{bmatrix},$$

but

$$\begin{bmatrix} 6 & 8 \\ 1 & 3 \end{bmatrix} \begin{bmatrix} 3 \\ 6 \end{bmatrix} = \begin{bmatrix} 8 & 7 \\ 3 & 2 \end{bmatrix} \begin{bmatrix} 3 \\ 6 \end{bmatrix}.$$

However, in practice, the probability that the algorithm makes a mistake is small, and we can decrease the probability by verifying the result using multiple random vectors  $X$  before reporting that  $AB = C$ .

## Graph coloring

Given a graph that contains  $n$  nodes and  $m$  edges, our task is to find a way to color the nodes of the graph using two colors so that for at least  $m/2$  edges, the endpoints have different colors. For example, in the graph

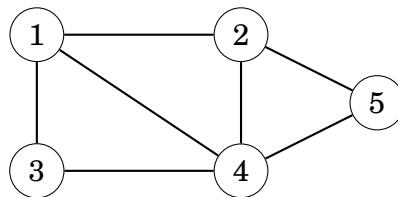

a valid coloring is as follows:

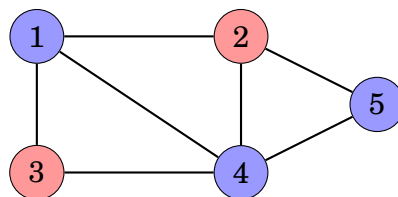

The above graph contains 7 edges, and for 5 of them, the endpoints have different colors, so the coloring is valid.

The problem can be solved using a Las Vegas algorithm that generates random colorings until a valid coloring has been found. In a random coloring, the color of each node is independently chosen so that the probability of both colors is  $1/2$ .

In a random coloring, the probability that the endpoints of a single edge have different colors is  $1/2$ . Hence, the expected number of edges whose endpoints have different colors is  $m/2$ . Since it is expected that a random coloring is valid, we will quickly find a valid coloring in practice.



# Chapter 25

## Game theory

In this chapter, we will focus on two-player games that do not contain random elements. Our goal is to find a strategy that we can follow to win the game no matter what the opponent does, if such a strategy exists.

It turns out that there is a general strategy for such games, and we can analyze the games using the **nim theory**. First, we will analyze simple games where players remove sticks from heaps, and after this, we will generalize the strategy used in those games to other games.

### 25.1 Game states

Let us consider a game where there is initially a heap of  $n$  sticks. Players  $A$  and  $B$  move alternately, and player  $A$  begins. On each move, the player has to remove 1, 2 or 3 sticks from the heap, and the player who removes the last stick wins the game.

For example, if  $n = 10$ , the game may proceed as follows:

- Player  $A$  removes 2 sticks (8 sticks left).
- Player  $B$  removes 3 sticks (5 sticks left).
- Player  $A$  removes 1 stick (4 sticks left).
- Player  $B$  removes 2 sticks (2 sticks left).
- Player  $A$  removes 2 sticks and wins.

This game consists of states  $0, 1, 2, \dots, n$ , where the number of the state corresponds to the number of sticks left.

### Winning and losing states

A **winning state** is a state where the player will win the game if they play optimally, and a **losing state** is a state where the player will lose the game if the opponent plays optimally. It turns out that we can classify all states of a game so that each state is either a winning state or a losing state.

In the above game, state 0 is clearly a losing state, because the player cannot make any moves. States 1, 2 and 3 are winning states, because we can remove 1,

2 or 3 sticks and win the game. State 4, in turn, is a losing state, because any move leads to a state that is a winning state for the opponent.

More generally, if there is a move that leads from the current state to a losing state, the current state is a winning state, and otherwise the current state is a losing state. Using this observation, we can classify all states of a game starting with losing states where there are no possible moves.

The states 0...15 of the above game can be classified as follows ( $W$  denotes a winning state and  $L$  denotes a losing state):

|     |     |     |     |     |     |     |     |     |     |     |     |     |     |     |     |
|-----|-----|-----|-----|-----|-----|-----|-----|-----|-----|-----|-----|-----|-----|-----|-----|
| 0   | 1   | 2   | 3   | 4   | 5   | 6   | 7   | 8   | 9   | 10  | 11  | 12  | 13  | 14  | 15  |
| $L$ | $W$ | $W$ | $W$ | $L$ | $W$ | $W$ | $W$ | $L$ | $W$ | $W$ | $W$ | $L$ | $W$ | $W$ | $W$ |

It is easy to analyze this game: a state  $k$  is a losing state if  $k$  is divisible by 4, and otherwise it is a winning state. An optimal way to play the game is to always choose a move after which the number of sticks in the heap is divisible by 4. Finally, there are no sticks left and the opponent has lost.

Of course, this strategy requires that the number of sticks is *not* divisible by 4 when it is our move. If it is, there is nothing we can do, and the opponent will win the game if they play optimally.

## State graph

Let us now consider another stick game, where in each state  $k$ , it is allowed to remove any number  $x$  of sticks such that  $x$  is smaller than  $k$  and divides  $k$ . For example, in state 8 we may remove 1, 2 or 4 sticks, but in state 7 the only allowed move is to remove 1 stick.

The following picture shows the states 1...9 of the game as a **state graph**, whose nodes are the states and edges are the moves between them:

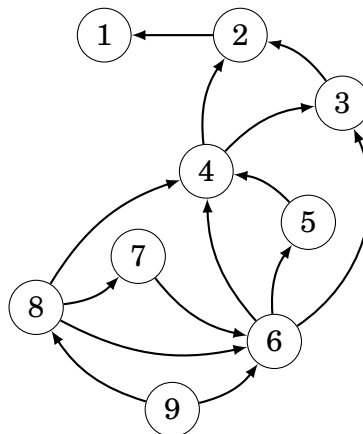

The final state in this game is always state 1, which is a losing state, because there are no valid moves. The classification of states 1...9 is as follows:

|     |     |     |     |     |     |     |     |     |
|-----|-----|-----|-----|-----|-----|-----|-----|-----|
| 1   | 2   | 3   | 4   | 5   | 6   | 7   | 8   | 9   |
| $L$ | $W$ | $L$ | $W$ | $L$ | $W$ | $L$ | $W$ | $L$ |

Surprisingly, in this game, all even-numbered states are winning states, and all odd-numbered states are losing states.

## 25.2 Nim game

The **nim game** is a simple game that has an important role in game theory, because many other games can be played using the same strategy. First, we focus on nim, and then we generalize the strategy to other games.

There are  $n$  heaps in nim, and each heap contains some number of sticks. The players move alternately, and on each turn, the player chooses a heap that still contains sticks and removes any number of sticks from it. The winner is the player who removes the last stick.

The states in nim are of the form  $[x_1, x_2, \dots, x_n]$ , where  $x_k$  denotes the number of sticks in heap  $k$ . For example,  $[10, 12, 5]$  is a game where there are three heaps with 10, 12 and 5 sticks. The state  $[0, 0, \dots, 0]$  is a losing state, because it is not possible to remove any sticks, and this is always the final state.

### Analysis

It turns out that we can easily classify any nim state by calculating the **nim sum**  $s = x_1 \oplus x_2 \oplus \dots \oplus x_n$ , where  $\oplus$  is the xor operation<sup>1</sup>. The states whose nim sum is 0 are losing states, and all other states are winning states. For example, the nim sum of  $[10, 12, 5]$  is  $10 \oplus 12 \oplus 5 = 3$ , so the state is a winning state.

But how is the nim sum related to the nim game? We can explain this by looking at how the nim sum changes when the nim state changes.

*Losing states:* The final state  $[0, 0, \dots, 0]$  is a losing state, and its nim sum is 0, as expected. In other losing states, any move leads to a winning state, because when a single value  $x_k$  changes, the nim sum also changes, so the nim sum is different from 0 after the move.

*Winning states:* We can move to a losing state if there is any heap  $k$  for which  $x_k \oplus s < x_k$ . In this case, we can remove sticks from heap  $k$  so that it will contain  $x_k \oplus s$  sticks, which will lead to a losing state. There is always such a heap, where  $x_k$  has a one bit at the position of the leftmost one bit of  $s$ .

As an example, consider the state  $[10, 12, 5]$ . This state is a winning state, because its nim sum is 3. Thus, there has to be a move which leads to a losing state. Next we will find out such a move.

The nim sum of the state is as follows:

$$\begin{array}{r|l} 10 & 1010 \\ 12 & 1100 \\ 5 & 0101 \\ \hline 3 & 0011 \end{array}$$

In this case, the heap with 10 sticks is the only heap that has a one bit at the position of the leftmost one bit of the nim sum:

$$\begin{array}{r|l} 10 & 10\underline{1}0 \\ 12 & 1100 \\ 5 & 0101 \\ \hline 3 & 00\underline{1}1 \end{array}$$

---

<sup>1</sup>The optimal strategy for nim was published in 1901 by C. L. Bouton [10].

The new size of the heap has to be  $10 \oplus 3 = 9$ , so we will remove just one stick. After this, the state will be  $[9, 12, 5]$ , which is a losing state:

|    |      |
|----|------|
| 9  | 1001 |
| 12 | 1100 |
| 5  | 0101 |
| 0  | 0000 |

## Misère game

In a **misère game**, the goal of the game is opposite, so the player who removes the last stick loses the game. It turns out that the misère nim game can be optimally played almost like the standard nim game.

The idea is to first play the misère game like the standard game, but change the strategy at the end of the game. The new strategy will be introduced in a situation where each heap would contain at most one stick after the next move.

In the standard game, we should choose a move after which there is an even number of heaps with one stick. However, in the misère game, we choose a move so that there is an odd number of heaps with one stick.

This strategy works because a state where the strategy changes always appears in the game, and this state is a winning state, because it contains exactly one heap that has more than one stick so the nim sum is not 0.

## 25.3 Sprague–Grundy theorem

The **Sprague–Grundy theorem**<sup>2</sup> generalizes the strategy used in nim to all games that fulfil the following requirements:

- There are two players who move alternately.
- The game consists of states, and the possible moves in a state do not depend on whose turn it is.
- The game ends when a player cannot make a move.
- The game surely ends sooner or later.
- The players have complete information about the states and allowed moves, and there is no randomness in the game.

The idea is to calculate for each game state a Grundy number that corresponds to the number of sticks in a nim heap. When we know the Grundy numbers of all states, we can play the game like the nim game.

### Grundy numbers

The **Grundy number** of a game state is

$$\text{mex}(\{g_1, g_2, \dots, g_n\}),$$

---

<sup>2</sup>The theorem was independently discovered by R. Sprague [61] and P. M. Grundy [31].



where  $g_1, g_2, \dots, g_n$  are the Grundy numbers of the states to which we can move, and the mex function gives the smallest nonnegative number that is not in the set. For example,  $\text{mex}(\{0, 1, 3\}) = 2$ . If there are no possible moves in a state, its Grundy number is 0, because  $\text{mex}(\emptyset) = 0$ .

For example, in the state graph

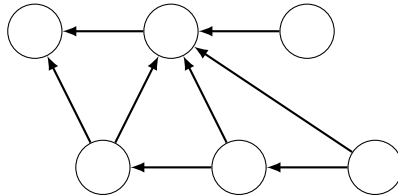

the Grundy numbers are as follows:

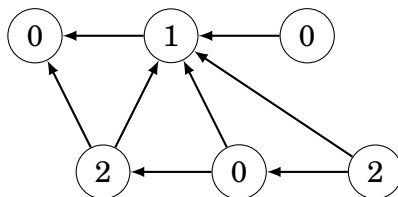

The Grundy number of a losing state is 0, and the Grundy number of a winning state is a positive number.

The Grundy number of a state corresponds to the number of sticks in a nim heap. If the Grundy number is 0, we can only move to states whose Grundy numbers are positive, and if the Grundy number is  $x > 0$ , we can move to states whose Grundy numbers include all numbers  $0, 1, \dots, x - 1$ .

As an example, consider a game where the players move a figure in a maze. Each square in the maze is either floor or wall. On each turn, the player has to move the figure some number of steps left or up. The winner of the game is the player who makes the last move.

The following picture shows a possible initial state of the game, where @ denotes the figure and \* denotes a square where it can move.

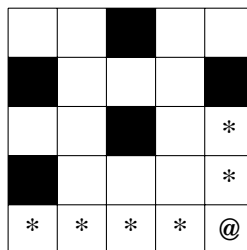

The states of the game are all floor squares of the maze. In the above maze, the Grundy numbers are as follows:

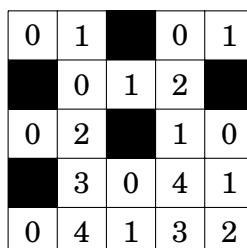

Thus, each state of the maze game corresponds to a heap in the nim game. For example, the Grundy number for the lower-right square is 2, so it is a winning state. We can reach a losing state and win the game by moving either four steps left or two steps up.

Note that unlike in the original nim game, it may be possible to move to a state whose Grundy number is larger than the Grundy number of the current state. However, the opponent can always choose a move that cancels such a move, so it is not possible to escape from a losing state.

## Subgames

Next we will assume that our game consists of subgames, and on each turn, the player first chooses a subgame and then a move in the subgame. The game ends when it is not possible to make any move in any subgame.

In this case, the Grundy number of a game is the nim sum of the Grundy numbers of the subgames. The game can be played like a nim game by calculating all Grundy numbers for subgames and then their nim sum.

As an example, consider a game that consists of three mazes. In this game, on each turn, the player chooses one of the mazes and then moves the figure in the maze. Assume that the initial state of the game is as follows:

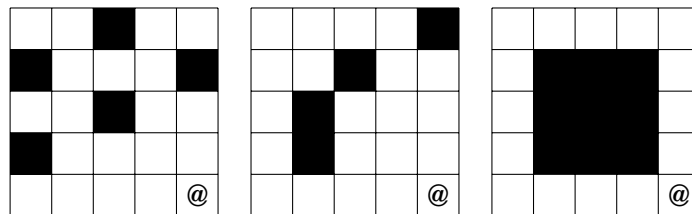

The Grundy numbers for the mazes are as follows:

|   |   |   |   |   |
|---|---|---|---|---|
| 0 | 1 | ■ | 0 | 1 |
| ■ | 0 | 1 | 2 | ■ |
| 0 | 2 | ■ | 1 | 0 |
| ■ | 3 | 0 | 4 | 1 |
| 0 | 4 | 1 | 3 | 2 |

|   |   |   |   |   |
|---|---|---|---|---|
| 0 | 1 | 2 | 3 | ■ |
| 1 | 0 | ■ | 0 | 1 |
| 2 | ■ | 0 | 1 | 2 |
| 3 | ■ | 1 | 2 | 0 |
| 4 | 0 | 2 | 5 | 3 |

|   |   |   |   |   |
|---|---|---|---|---|
| 0 | 1 | 2 | 3 | 4 |
| 1 | ■ | ■ | ■ | 0 |
| 2 | ■ | ■ | ■ | 1 |
| 3 | ■ | ■ | ■ | 2 |
| 4 | 0 | 1 | 2 | 3 |

In the initial state, the nim sum of the Grundy numbers is  $2 \oplus 3 \oplus 3 = 2$ , so the first player can win the game. One optimal move is to move two steps up in the first maze, which produces the nim sum  $0 \oplus 3 \oplus 3 = 0$ .

## Grundy's game

Sometimes a move in a game divides the game into subgames that are independent of each other. In this case, the Grundy number of the game is

$$\text{mex}(\{g_1, g_2, \dots, g_n\}),$$

where  $n$  is the number of possible moves and

$$g_k = a_{k,1} \oplus a_{k,2} \oplus \dots \oplus a_{k,m},$$

where move  $k$  generates subgames with Grundy numbers  $a_{k,1}, a_{k,2}, \dots, a_{k,m}$ .

An example of such a game is **Grundy's game**. Initially, there is a single heap that contains  $n$  sticks. On each turn, the player chooses a heap and divides it into two nonempty heaps such that the heaps are of different size. The player who makes the last move wins the game.

Let  $f(n)$  be the Grundy number of a heap that contains  $n$  sticks. The Grundy number can be calculated by going through all ways to divide the heap into two heaps. For example, when  $n = 8$ , the possibilities are  $1 + 7$ ,  $2 + 6$  and  $3 + 5$ , so

$$f(8) = \text{mex}(\{f(1) \oplus f(7), f(2) \oplus f(6), f(3) \oplus f(5)\}).$$

In this game, the value of  $f(n)$  is based on the values of  $f(1), \dots, f(n-1)$ . The base cases are  $f(1) = f(2) = 0$ , because it is not possible to divide the heaps of 1 and 2 sticks. The first Grundy numbers are:

$$\begin{aligned} f(1) &= 0 \\ f(2) &= 0 \\ f(3) &= 1 \\ f(4) &= 0 \\ f(5) &= 2 \\ f(6) &= 1 \\ f(7) &= 0 \\ f(8) &= 2 \end{aligned}$$

The Grundy number for  $n = 8$  is 2, so it is possible to win the game. The winning move is to create heaps  $1 + 7$ , because  $f(1) \oplus f(7) = 0$ .



# Chapter 26

## String algorithms

This chapter deals with efficient algorithms for string processing. Many string problems can be easily solved in  $O(n^2)$  time, but the challenge is to find algorithms that work in  $O(n)$  or  $O(n \log n)$  time.

For example, a fundamental string processing problem is the **pattern matching** problem: given a string of length  $n$  and a pattern of length  $m$ , our task is to find the occurrences of the pattern in the string. For example, the pattern ABC occurs two times in the string ABABCBAABC.

The pattern matching problem can be easily solved in  $O(nm)$  time by a brute force algorithm that tests all positions where the pattern may occur in the string. However, in this chapter, we will see that there are more efficient algorithms that require only  $O(n + m)$  time.

### 26.1 String terminology

Throughout the chapter, we assume that zero-based indexing is used in strings. Thus, a string  $s$  of length  $n$  consists of characters  $s[0], s[1], \dots, s[n - 1]$ . The set of characters that may appear in strings is called an **alphabet**. For example, the alphabet  $\{A, B, \dots, Z\}$  consists of the capital letters of English.

A **substring** is a sequence of consecutive characters in a string. We use the notation  $s[a \dots b]$  to refer to a substring of  $s$  that begins at position  $a$  and ends at position  $b$ . A string of length  $n$  has  $n(n + 1)/2$  substrings. For example, the substrings of ABCD are A, B, C, D, AB, BC, CD, ABC, BCD and ABCD.

A **subsequence** is a sequence of (not necessarily consecutive) characters in a string in their original order. A string of length  $n$  has  $2^n - 1$  subsequences. For example, the subsequences of ABCD are A, B, C, D, AB, AC, AD, BC, BD, CD, ABC, ABD, ACD, BCD and ABCD.

A **prefix** is a substring that starts at the beginning of a string, and a **suffix** is a substring that ends at the end of a string. For example, the prefixes of ABCD are A, AB, ABC and ABCD, and the suffixes of ABCD are D, CD, BCD and ABCD.

A **rotation** can be generated by moving the characters of a string one by one from the beginning to the end (or vice versa). For example, the rotations of ABCD are ABCD, BCDA, CDAB and DABC.

A **period** is a prefix of a string such that the string can be constructed by repeating the period. The last repetition may be partial and contain only a prefix of the period. For example, the shortest period of ABCABCA is ABC.

A **border** is a string that is both a prefix and a suffix of a string. For example, the borders of ABACABA are A, ABA and ABACABA.

Strings are compared using the **lexicographical order** (which corresponds to the alphabetical order). It means that  $x < y$  if either  $x \neq y$  and  $x$  is a prefix of  $y$ , or there is a position  $k$  such that  $x[i] = y[i]$  when  $i < k$  and  $x[k] < y[k]$ .

## 26.2 Trie structure

A **trie** is a rooted tree that maintains a set of strings. Each string in the set is stored as a chain of characters that starts at the root. If two strings have a common prefix, they also have a common chain in the tree.

For example, consider the following trie:

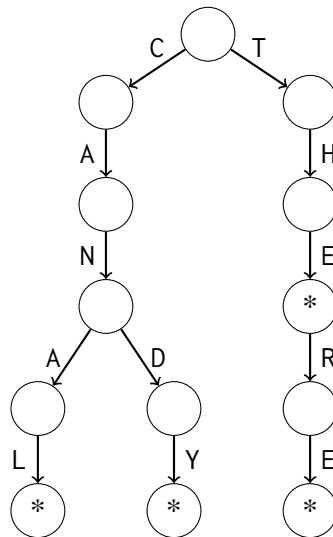

This trie corresponds to the set {CANAL, CANDY, THE, THERE}. The character \* in a node means that a string in the set ends at the node. Such a character is needed, because a string may be a prefix of another string. For example, in the above trie, THE is a prefix of THERE.

We can check in  $O(n)$  time whether a trie contains a string of length  $n$ , because we can follow the chain that starts at the root node. We can also add a string of length  $n$  to the trie in  $O(n)$  time by first following the chain and then adding new nodes to the trie if necessary.

Using a trie, we can find the longest prefix of a given string such that the prefix belongs to the set. Moreover, by storing additional information in each node, we can calculate the number of strings that belong to the set and have a given string as a prefix.

A trie can be stored in an array

```
int trie[N][A];
```

where  $N$  is the maximum number of nodes (the maximum total length of the strings in the set) and  $A$  is the size of the alphabet. The nodes of a trie are numbered  $0, 1, 2, \dots$  so that the number of the root is  $0$ , and  $\text{trie}[s][c]$  is the next node in the chain when we move from node  $s$  using character  $c$ .

## 26.3 String hashing

**String hashing** is a technique that allows us to efficiently check whether two strings are equal<sup>1</sup>. The idea in string hashing is to compare hash values of strings instead of their individual characters.

### Calculating hash values

A **hash value** of a string is a number that is calculated from the characters of the string. If two strings are the same, their hash values are also the same, which makes it possible to compare strings based on their hash values.

A usual way to implement string hashing is **polynomial hashing**, which means that the hash value of a string  $s$  of length  $n$  is

$$(s[0]A^{n-1} + s[1]A^{n-2} + \dots + s[n-1]A^0) \bmod B,$$

where  $s[0], s[1], \dots, s[n-1]$  are interpreted as the codes of the characters of  $s$ , and  $A$  and  $B$  are pre-chosen constants.

For example, the codes of the characters of ALLEY are:

|    |    |    |    |    |
|----|----|----|----|----|
| A  | L  | L  | E  | Y  |
| 65 | 76 | 76 | 69 | 89 |

Thus, if  $A = 3$  and  $B = 97$ , the hash value of ALLEY is

$$(65 \cdot 3^4 + 76 \cdot 3^3 + 76 \cdot 3^2 + 69 \cdot 3^1 + 89 \cdot 3^0) \bmod 97 = 52.$$

### Preprocessing

Using polynomial hashing, we can calculate the hash value of any substring of a string  $s$  in  $O(1)$  time after an  $O(n)$  time preprocessing. The idea is to construct an array  $h$  such that  $h[k]$  contains the hash value of the prefix  $s[0 \dots k]$ . The array values can be recursively calculated as follows:

$$\begin{aligned} h[0] &= s[0] \\ h[k] &= (h[k-1]A + s[k]) \bmod B \end{aligned}$$

In addition, we construct an array  $p$  where  $p[k] = A^k \bmod B$ :

$$\begin{aligned} p[0] &= 1 \\ p[k] &= (p[k-1]A) \bmod B. \end{aligned}$$

<sup>1</sup>The technique was popularized by the Karp–Rabin pattern matching algorithm [42].

Constructing these arrays takes  $O(n)$  time. After this, the hash value of any substring  $s[a \dots b]$  can be calculated in  $O(1)$  time using the formula

$$(h[b] - h[a - 1]p[b - a + 1]) \bmod B$$

assuming that  $a > 0$ . If  $a = 0$ , the hash value is simply  $h[b]$ .

## Using hash values

We can efficiently compare strings using hash values. Instead of comparing the individual characters of the strings, the idea is to compare their hash values. If the hash values are equal, the strings are *probably* equal, and if the hash values are different, the strings are *certainly* different.

Using hashing, we can often make a brute force algorithm efficient. As an example, consider the pattern matching problem: given a string  $s$  and a pattern  $p$ , find the positions where  $p$  occurs in  $s$ . A brute force algorithm goes through all positions where  $p$  may occur and compares the strings character by character. The time complexity of such an algorithm is  $O(n^2)$ .

We can make the brute force algorithm more efficient by using hashing, because the algorithm compares substrings of strings. Using hashing, each comparison only takes  $O(1)$  time, because only hash values of substrings are compared. This results in an algorithm with time complexity  $O(n)$ , which is the best possible time complexity for this problem.

By combining hashing and *binary search*, it is also possible to find out the lexicographic order of two strings in logarithmic time. This can be done by calculating the length of the common prefix of the strings using binary search. Once we know the length of the common prefix, we can just check the next character after the prefix, because this determines the order of the strings.

## Collisions and parameters

An evident risk when comparing hash values is a **collision**, which means that two strings have different contents but equal hash values. In this case, an algorithm that relies on the hash values concludes that the strings are equal, but in reality they are not, and the algorithm may give incorrect results.

Collisions are always possible, because the number of different strings is larger than the number of different hash values. However, the probability of a collision is small if the constants  $A$  and  $B$  are carefully chosen. A usual way is to choose random constants near  $10^9$ , for example as follows:

$$\begin{aligned} A &= 911382323 \\ B &= 972663749 \end{aligned}$$

Using such constants, the `long long` type can be used when calculating hash values, because the products  $AB$  and  $BB$  will fit in `long long`. But is it enough to have about  $10^9$  different hash values?

Let us consider three scenarios where hashing can be used:



*Scenario 1:* Strings  $x$  and  $y$  are compared with each other. The probability of a collision is  $1/B$  assuming that all hash values are equally probable.

*Scenario 2:* A string  $x$  is compared with strings  $y_1, y_2, \dots, y_n$ . The probability of one or more collisions is

$$1 - \left(1 - \frac{1}{B}\right)^n.$$

*Scenario 3:* All pairs of strings  $x_1, x_2, \dots, x_n$  are compared with each other. The probability of one or more collisions is

$$1 - \frac{B \cdot (B - 1) \cdot (B - 2) \cdots (B - n + 1)}{B^n}.$$

The following table shows the collision probabilities when  $n = 10^6$  and the value of  $B$  varies:

| constant $B$ | scenario 1 | scenario 2 | scenario 3 |
|--------------|------------|------------|------------|
| $10^3$       | 0.001000   | 1.000000   | 1.000000   |
| $10^6$       | 0.000001   | 0.632121   | 1.000000   |
| $10^9$       | 0.000000   | 0.001000   | 1.000000   |
| $10^{12}$    | 0.000000   | 0.000000   | 0.393469   |
| $10^{15}$    | 0.000000   | 0.000000   | 0.000500   |
| $10^{18}$    | 0.000000   | 0.000000   | 0.000001   |

The table shows that in scenario 1, the probability of a collision is negligible when  $B \approx 10^9$ . In scenario 2, a collision is possible but the probability is still quite small. However, in scenario 3 the situation is very different: a collision will almost always happen when  $B \approx 10^9$ .

The phenomenon in scenario 3 is known as the **birthday paradox**: if there are  $n$  people in a room, the probability that *some* two people have the same birthday is large even if  $n$  is quite small. In hashing, correspondingly, when all hash values are compared with each other, the probability that some two hash values are equal is large.

We can make the probability of a collision smaller by calculating *multiple* hash values using different parameters. It is unlikely that a collision would occur in all hash values at the same time. For example, two hash values with parameter  $B \approx 10^9$  correspond to one hash value with parameter  $B \approx 10^{18}$ , which makes the probability of a collision very small.

Some people use constants  $B = 2^{32}$  and  $B = 2^{64}$ , which is convenient, because operations with 32 and 64 bit integers are calculated modulo  $2^{32}$  and  $2^{64}$ . However, this is *not* a good choice, because it is possible to construct inputs that always generate collisions when constants of the form  $2^x$  are used [52].

## 26.4 Z-algorithm

The **Z-array**  $z$  of a string  $s$  of length  $n$  contains for each  $k = 0, 1, \dots, n - 1$  the length of the longest substring of  $s$  that begins at position  $k$  and is a prefix of

s. Thus,  $z[k] = p$  tells us that  $s[0 \dots p - 1]$  equals  $s[k \dots k + p - 1]$ . Many string processing problems can be efficiently solved using the Z-array.

For example, the Z-array of ACBACDACBACBACDA is as follows:

|   |   |   |   |   |   |   |   |   |   |   |    |    |    |    |    |    |
|---|---|---|---|---|---|---|---|---|---|---|----|----|----|----|----|----|
|   | 0 | 1 | 2 | 3 | 4 | 5 | 6 | 7 | 8 | 9 | 10 | 11 | 12 | 13 | 14 | 15 |
| A | C | B | A | C | D | A | C | B | A | C | B  | A  | C  | D  | A  |    |
| - | 0 | 0 | 2 | 0 | 0 | 5 | 0 | 0 | 7 | 0 | 0  | 2  | 0  | 0  | 1  |    |

In this case, for example,  $z[6] = 5$ , because the substring ACBAC of length 5 is a prefix of s, but the substring ACBACB of length 6 is not a prefix of s.

## Algorithm description

Next we describe an algorithm, called the **Z-algorithm**<sup>2</sup>, that efficiently constructs the Z-array in  $O(n)$  time. The algorithm calculates the Z-array values from left to right by both using information already stored in the Z-array and comparing substrings character by character.

To efficiently calculate the Z-array values, the algorithm maintains a range  $[x, y]$  such that  $s[x \dots y]$  is a prefix of s and  $y$  is as large as possible. Since we know that  $s[0 \dots y - x]$  and  $s[x \dots y]$  are equal, we can use this information when calculating Z-values for positions  $x + 1, x + 2, \dots, y$ .

At each position  $k$ , we first check the value of  $z[k - x]$ . If  $k + z[k - x] < y$ , we know that  $z[k] = z[k - x]$ . However, if  $k + z[k - x] \geq y$ ,  $s[0 \dots y - k]$  equals  $s[k \dots y]$ , and to determine the value of  $z[k]$  we need to compare the substrings character by character. Still, the algorithm works in  $O(n)$  time, because we start comparing at positions  $y - k + 1$  and  $y + 1$ .

For example, let us construct the following Z-array:

|   |   |   |   |   |   |   |   |   |   |   |    |    |    |    |    |    |
|---|---|---|---|---|---|---|---|---|---|---|----|----|----|----|----|----|
|   | 0 | 1 | 2 | 3 | 4 | 5 | 6 | 7 | 8 | 9 | 10 | 11 | 12 | 13 | 14 | 15 |
| A | C | B | A | C | D | A | C | B | A | C | B  | A  | C  | D  | A  |    |
| - | ? | ? | ? | ? | ? | ? | ? | ? | ? | ? | ?  | ?  | ?  | ?  | ?  |    |

After calculating the value  $z[6] = 5$ , the current  $[x, y]$  range is  $[6, 10]$ :

|   |   |   |   |   |   |               |   |   |   |     |   |   |   |   |   |  |  |
|---|---|---|---|---|---|---------------|---|---|---|-----|---|---|---|---|---|--|--|
|   |   |   |   |   |   | $x$           |   |   |   | $y$ |   |   |   |   |   |  |  |
|   |   |   |   |   |   | ┌───────────┐ |   |   |   |     |   |   |   |   |   |  |  |
|   |   |   |   |   |   | 6             | 7 | 8 | 9 | 10  |   |   |   |   |   |  |  |
| A | C | B | A | C | D | A             | C | B | A | C   | B | A | C | D | A |  |  |
| - | 0 | 0 | 2 | 0 | 0 | 5             | ? | ? | ? | ?   | ? | ? | ? | ? | ? |  |  |

Now we can calculate subsequent Z-array values efficiently, because we know that  $s[0 \dots 4]$  and  $s[6 \dots 10]$  are equal. First, since  $z[1] = z[2] = 0$ , we immediately know that also  $z[7] = z[8] = 0$ :

<sup>2</sup>The Z-algorithm was presented in [32] as the simplest known method for linear-time pattern matching, and the original idea was attributed to [50].

|   |   |   |   |   |   |     |   |   |     |    |    |    |    |    |    |  |
|---|---|---|---|---|---|-----|---|---|-----|----|----|----|----|----|----|--|
|   |   |   |   |   |   | $x$ |   |   | $y$ |    |    |    |    |    |    |  |
| 0 | 1 | 2 | 3 | 4 | 5 | 6   | 7 | 8 | 9   | 10 | 11 | 12 | 13 | 14 | 15 |  |
| A | C | B | A | C | D | A   | C | B | A   | C  | B  | A  | C  | D  | A  |  |
| - | 0 | 0 | 2 | 0 | 0 | 5   | 0 | 0 | ?   | ?  | ?  | ?  | ?  | ?  | ?  |  |



Then, since  $z[3] = 2$ , we know that  $z[9] \geq 2$ :

|   |   |   |   |   |   |     |   |   |     |    |    |    |    |    |    |  |
|---|---|---|---|---|---|-----|---|---|-----|----|----|----|----|----|----|--|
|   |   |   |   |   |   | $x$ |   |   | $y$ |    |    |    |    |    |    |  |
| 0 | 1 | 2 | 3 | 4 | 5 | 6   | 7 | 8 | 9   | 10 | 11 | 12 | 13 | 14 | 15 |  |
| A | C | B | A | C | D | A   | C | B | A   | C  | B  | A  | C  | D  | A  |  |
| - | 0 | 0 | 2 | 0 | 0 | 5   | 0 | 0 | ?   | ?  | ?  | ?  | ?  | ?  | ?  |  |



However, we have no information about the string after position 10, so we need to compare the substrings character by character:

|   |   |   |   |   |   |     |   |   |     |    |    |    |    |    |    |  |
|---|---|---|---|---|---|-----|---|---|-----|----|----|----|----|----|----|--|
|   |   |   |   |   |   | $x$ |   |   | $y$ |    |    |    |    |    |    |  |
| 0 | 1 | 2 | 3 | 4 | 5 | 6   | 7 | 8 | 9   | 10 | 11 | 12 | 13 | 14 | 15 |  |
| A | C | B | A | C | D | A   | C | B | A   | C  | B  | A  | C  | D  | A  |  |
| - | 0 | 0 | 2 | 0 | 0 | 5   | 0 | 0 | ?   | ?  | ?  | ?  | ?  | ?  | ?  |  |

It turns out that  $z[9] = 7$ , so the new  $[x, y]$  range is  $[9, 15]$ :

|   |   |   |   |   |   |   |   |   |     |    |    |    |    |    |     |  |  |  |
|---|---|---|---|---|---|---|---|---|-----|----|----|----|----|----|-----|--|--|--|
|   |   |   |   |   |   |   |   |   | $x$ |    |    |    |    |    | $y$ |  |  |  |
| 0 | 1 | 2 | 3 | 4 | 5 | 6 | 7 | 8 | 9   | 10 | 11 | 12 | 13 | 14 | 15  |  |  |  |
| A | C | B | A | C | D | A | C | B | A   | C  | B  | A  | C  | D  | A   |  |  |  |
| - | 0 | 0 | 2 | 0 | 0 | 5 | 0 | 0 | 7   | ?  | ?  | ?  | ?  | ?  | ?   |  |  |  |

After this, all the remaining Z-array values can be determined by using the information already stored in the Z-array:

|   |   |   |   |   |   |   |   |   |     |    |    |    |    |    |     |  |  |  |
|---|---|---|---|---|---|---|---|---|-----|----|----|----|----|----|-----|--|--|--|
|   |   |   |   |   |   |   |   |   | $x$ |    |    |    |    |    | $y$ |  |  |  |
| 0 | 1 | 2 | 3 | 4 | 5 | 6 | 7 | 8 | 9   | 10 | 11 | 12 | 13 | 14 | 15  |  |  |  |
| A | C | B | A | C | D | A | C | B | A   | C  | B  | A  | C  | D  | A   |  |  |  |
| - | 0 | 0 | 2 | 0 | 0 | 5 | 0 | 0 | 7   | 0  | 0  | 2  | 0  | 0  | 1   |  |  |  |

## Using the Z-array

It is often a matter of taste whether to use string hashing or the Z-algorithm. Unlike hashing, the Z-algorithm always works and there is no risk for collisions. On the other hand, the Z-algorithm is more difficult to implement and some problems can only be solved using hashing.

As an example, consider again the pattern matching problem, where our task is to find the occurrences of a pattern  $p$  in a string  $s$ . We already solved this problem efficiently using string hashing, but the Z-algorithm provides another way to solve the problem.

A usual idea in string processing is to construct a string that consists of multiple strings separated by special characters. In this problem, we can construct a string  $p\#s$ , where  $p$  and  $s$  are separated by a special character  $\#$  that does not occur in the strings. The Z-array of  $p\#s$  tells us the positions where  $p$  occurs in  $s$ , because such positions contain the length of  $p$ .

For example, if  $s = \text{HATTIVATTI}$  and  $p = \text{ATT}$ , the Z-array is as follows:

|   |   |   |   |   |   |   |   |   |   |    |    |    |    |
|---|---|---|---|---|---|---|---|---|---|----|----|----|----|
| 0 | 1 | 2 | 3 | 4 | 5 | 6 | 7 | 8 | 9 | 10 | 11 | 12 | 13 |
| A | T | T | # | H | A | T | T | I | V | A  | T  | T  | I  |
| - | 0 | 0 | 0 | 0 | 3 | 0 | 0 | 0 | 0 | 3  | 0  | 0  | 0  |

The positions 5 and 10 contain the value 3, which means that the pattern ATT occurs in the corresponding positions of HATTIVATTI.

The time complexity of the resulting algorithm is linear, because it suffices to construct the Z-array and go through its values.

## Implementation

Here is a short implementation of the Z-algorithm that returns a vector that corresponds to the Z-array.

```
vector<int> z(string s) {
    int n = s.size();
    vector<int> z(n);
    int x = 0, y = 0;
    for (int i = 1; i < n; i++) {
        z[i] = max(0, min(z[i-x], y-i+1));
        while (i+z[i] < n && s[z[i]] == s[i+z[i]]) {
            x = i; y = i+z[i]; z[i]++;
        }
    }
    return z;
}
```

# Chapter 27

## Square root algorithms

A **square root algorithm** is an algorithm that has a square root in its time complexity. A square root can be seen as a "poor man's logarithm": the complexity  $O(\sqrt{n})$  is better than  $O(n)$  but worse than  $O(\log n)$ . In any case, many square root algorithms are fast and usable in practice.

As an example, consider the problem of creating a data structure that supports two operations on an array: modifying an element at a given position and calculating the sum of elements in the given range. We have previously solved the problem using binary indexed and segment trees, that support both operations in  $O(\log n)$  time. However, now we will solve the problem in another way using a square root structure that allows us to modify elements in  $O(1)$  time and calculate sums in  $O(\sqrt{n})$  time.

The idea is to divide the array into *blocks* of size  $\sqrt{n}$  so that each block contains the sum of elements inside the block. For example, an array of 16 elements will be divided into blocks of 4 elements as follows:

|    |   |   |   |    |   |   |   |    |   |   |   |    |   |   |   |
|----|---|---|---|----|---|---|---|----|---|---|---|----|---|---|---|
| 21 |   |   |   | 17 |   |   |   | 20 |   |   |   | 13 |   |   |   |
| 5  | 8 | 6 | 3 | 2  | 7 | 2 | 6 | 7  | 1 | 7 | 5 | 6  | 2 | 3 | 2 |

In this structure, it is easy to modify array elements, because it is only needed to update the sum of a single block after each modification, which can be done in  $O(1)$  time. For example, the following picture shows how the value of an element and the sum of the corresponding block change:

|    |   |   |   |    |   |   |   |    |   |   |   |    |   |   |   |
|----|---|---|---|----|---|---|---|----|---|---|---|----|---|---|---|
| 21 |   |   |   | 15 |   |   |   | 20 |   |   |   | 13 |   |   |   |
| 5  | 8 | 6 | 3 | 2  | 5 | 2 | 6 | 7  | 1 | 7 | 5 | 6  | 2 | 3 | 2 |

Then, to calculate the sum of elements in a range, we divide the range into three parts such that the sum consists of values of single elements and sums of blocks between them:

|    |   |   |   |    |   |   |   |    |   |   |   |    |   |   |   |
|----|---|---|---|----|---|---|---|----|---|---|---|----|---|---|---|
| 21 |   |   |   | 15 |   |   |   | 20 |   |   |   | 13 |   |   |   |
| 5  | 8 | 6 | 3 | 2  | 5 | 2 | 6 | 7  | 1 | 7 | 5 | 6  | 2 | 3 | 2 |

Since the number of single elements is  $O(\sqrt{n})$  and the number of blocks is also  $O(\sqrt{n})$ , the sum query takes  $O(\sqrt{n})$  time. The purpose of the block size  $\sqrt{n}$  is that it *balances* two things: the array is divided into  $\sqrt{n}$  blocks, each of which contains  $\sqrt{n}$  elements.

In practice, it is not necessary to use the exact value of  $\sqrt{n}$  as a parameter, and instead we may use parameters  $k$  and  $n/k$  where  $k$  is different from  $\sqrt{n}$ . The optimal parameter depends on the problem and input. For example, if an algorithm often goes through the blocks but rarely inspects single elements inside the blocks, it may be a good idea to divide the array into  $k < \sqrt{n}$  blocks, each of which contains  $n/k > \sqrt{n}$  elements.

## 27.1 Combining algorithms

In this section we discuss two square root algorithms that are based on combining two algorithms into one algorithm. In both cases, we could use either of the algorithms without the other and solve the problem in  $O(n^2)$  time. However, by combining the algorithms, the running time is only  $O(n\sqrt{n})$ .

### Case processing

Suppose that we are given a two-dimensional grid that contains  $n$  cells. Each cell is assigned a letter, and our task is to find two cells with the same letter whose distance is minimum, where the distance between cells  $(x_1, y_1)$  and  $(x_2, y_2)$  is  $|x_1 - x_2| + |y_1 - y_2|$ . For example, consider the following grid:

|   |   |   |   |
|---|---|---|---|
| A | F | B | A |
| C | E | G | E |
| B | D | A | F |
| A | C | B | D |

In this case, the minimum distance is 2 between the two 'E' letters.

We can solve the problem by considering each letter separately. Using this approach, the new problem is to calculate the minimum distance between two cells with a *fixed* letter  $c$ . We focus on two algorithms for this:

*Algorithm 1:* Go through all pairs of cells with letter  $c$ , and calculate the minimum distance between such cells. This will take  $O(k^2)$  time where  $k$  is the number of cells with letter  $c$ .

*Algorithm 2:* Perform a breadth-first search that simultaneously starts at each cell with letter  $c$ . The minimum distance between two cells with letter  $c$  will be calculated in  $O(n)$  time.

One way to solve the problem is to choose either of the algorithms and use it for all letters. If we use Algorithm 1, the running time is  $O(n^2)$ , because all cells may contain the same letter, and in this case  $k = n$ . Also if we use Algorithm 2, the running time is  $O(n^2)$ , because all cells may have different letters, and in this case  $n$  searches are needed.

However, we can *combine* the two algorithms and use different algorithms for different letters depending on how many times each letter appears in the grid. Assume that a letter  $c$  appears  $k$  times. If  $k \leq \sqrt{n}$ , we use Algorithm 1, and if  $k > \sqrt{n}$ , we use Algorithm 2. It turns out that by doing this, the total running time of the algorithm is only  $O(n\sqrt{n})$ .

First, suppose that we use Algorithm 1 for a letter  $c$ . Since  $c$  appears at most  $\sqrt{n}$  times in the grid, we compare each cell with letter  $c$   $O(\sqrt{n})$  times with other cells. Thus, the time used for processing all such cells is  $O(n\sqrt{n})$ . Then, suppose that we use Algorithm 2 for a letter  $c$ . There are at most  $\sqrt{n}$  such letters, so processing those letters also takes  $O(n\sqrt{n})$  time.

## Batch processing

Our next problem also deals with a two-dimensional grid that contains  $n$  cells. Initially, each cell except one is white. We perform  $n - 1$  operations, each of which first calculates the minimum distance from a given white cell to a black cell, and then paints the white cell black.

For example, consider the following operation:

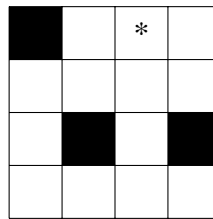

First, we calculate the minimum distance from the white cell marked with  $*$  to a black cell. The minimum distance is 2, because we can move two steps left to a black cell. Then, we paint the white cell black:

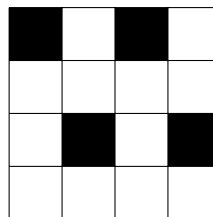

Consider the following two algorithms:

*Algorithm 1:* Use breadth-first search to calculate for each white cell the distance to the nearest black cell. This takes  $O(n)$  time, and after the search, we can find the minimum distance from any white cell to a black cell in  $O(1)$  time.

*Algorithm 2:* Maintain a list of cells that have been painted black, go through this list at each operation and then add a new cell to the list. An operation takes  $O(k)$  time where  $k$  is the length of the list.

We combine the above algorithms by dividing the operations into  $O(\sqrt{n})$  *batches*, each of which consists of  $O(\sqrt{n})$  operations. At the beginning of each batch, we perform Algorithm 1. Then, we use Algorithm 2 to process the operations in the batch. We clear the list of Algorithm 2 between the batches. At each

operation, the minimum distance to a black cell is either the distance calculated by Algorithm 1 or the distance calculated by Algorithm 2.

The resulting algorithm works in  $O(n\sqrt{n})$  time. First, Algorithm 1 is performed  $O(\sqrt{n})$  times, and each search works in  $O(n)$  time. Second, when using Algorithm 2 in a batch, the list contains  $O(\sqrt{n})$  cells (because we clear the list between the batches) and each operation takes  $O(\sqrt{n})$  time.

## 27.2 Integer partitions

Some square root algorithms are based on the following observation: if a positive integer  $n$  is represented as a sum of positive integers, such a sum always contains at most  $O(\sqrt{n})$  *distinct* numbers. The reason for this is that to construct a sum that contains a maximum number of distinct numbers, we should choose *small* numbers. If we choose the numbers  $1, 2, \dots, k$ , the resulting sum is

$$\frac{k(k+1)}{2}.$$

Thus, the maximum amount of distinct numbers is  $k = O(\sqrt{n})$ . Next we will discuss two problems that can be solved efficiently using this observation.

### Knapsack

Suppose that we are given a list of integer weights whose sum is  $n$ . Our task is to find out all sums that can be formed using a subset of the weights. For example, if the weights are  $\{1, 3, 3\}$ , the possible sums are as follows:

- 0 (empty set)
- 1
- 3
- $1 + 3 = 4$
- $3 + 3 = 6$
- $1 + 3 + 3 = 7$

Using the standard knapsack approach (see Chapter 7.4), the problem can be solved as follows: we define a function  $\text{possible}(x, k)$  whose value is 1 if the sum  $x$  can be formed using the first  $k$  weights, and 0 otherwise. Since the sum of the weights is  $n$ , there are at most  $n$  weights and all values of the function can be calculated in  $O(n^2)$  time using dynamic programming.

However, we can make the algorithm more efficient by using the fact that there are at most  $O(\sqrt{n})$  *distinct* weights. Thus, we can process the weights in groups that consists of similar weights. We can process each group in  $O(n)$  time, which yields an  $O(n\sqrt{n})$  time algorithm.

The idea is to use an array that records the sums of weights that can be formed using the groups processed so far. The array contains  $n$  elements: element  $k$  is 1 if the sum  $k$  can be formed and 0 otherwise. To process a group of weights, we scan the array from left to right and record the new sums of weights that can be formed using this group and the previous groups.



## String construction

Given a string  $s$  of length  $n$  and a set of strings  $D$  whose total length is  $m$ , consider the problem of counting the number of ways  $s$  can be formed as a concatenation of strings in  $D$ . For example, if  $s = ABAB$  and  $D = \{A, B, AB\}$ , there are 4 ways:

- $A + B + A + B$
- $AB + A + B$
- $A + B + AB$
- $AB + AB$

We can solve the problem using dynamic programming: Let  $\text{count}(k)$  denote the number of ways to construct the prefix  $s[0 \dots k]$  using the strings in  $D$ . Now  $\text{count}(n - 1)$  gives the answer to the problem, and we can solve the problem in  $O(n^2)$  time using a trie structure.

However, we can solve the problem more efficiently by using string hashing and the fact that there are at most  $O(\sqrt{m})$  distinct string lengths in  $D$ . First, we construct a set  $H$  that contains all hash values of the strings in  $D$ . Then, when calculating a value of  $\text{count}(k)$ , we go through all values of  $p$  such that there is a string of length  $p$  in  $D$ , calculate the hash value of  $s[k - p + 1 \dots k]$  and check if it belongs to  $H$ . Since there are at most  $O(\sqrt{m})$  distinct string lengths, this results in an algorithm whose running time is  $O(n\sqrt{m})$ .

## 27.3 Mo's algorithm

**Mo's algorithm**<sup>1</sup> can be used in many problems that require processing range queries in a *static* array, i.e., the array values do not change between the queries. In each query, we are given a range  $[a, b]$ , and we should calculate a value based on the array elements between positions  $a$  and  $b$ . Since the array is static, the queries can be processed in any order, and Mo's algorithm processes the queries in a special order which guarantees that the algorithm works efficiently.

Mo's algorithm maintains an *active range* of the array, and the answer to a query concerning the active range is known at each moment. The algorithm processes the queries one by one, and always moves the endpoints of the active range by inserting and removing elements. The time complexity of the algorithm is  $O(n\sqrt{n}f(n))$  where the array contains  $n$  elements, there are  $n$  queries and each insertion and removal of an element takes  $O(f(n))$  time.

The trick in Mo's algorithm is the order in which the queries are processed: The array is divided into blocks of  $k = O(\sqrt{n})$  elements, and a query  $[a_1, b_1]$  is processed before a query  $[a_2, b_2]$  if either

- $\lfloor a_1/k \rfloor < \lfloor a_2/k \rfloor$  or
- $\lfloor a_1/k \rfloor = \lfloor a_2/k \rfloor$  and  $b_1 < b_2$ .

---

<sup>1</sup>According to [12], this algorithm is named after Mo Tao, a Chinese competitive programmer, but the technique has appeared earlier in the literature [44].

Thus, all queries whose left endpoints are in a certain block are processed one after another sorted according to their right endpoints. Using this order, the algorithm only performs  $O(n\sqrt{n})$  operations, because the left endpoint moves  $O(n)$  times  $O(\sqrt{n})$  steps, and the right endpoint moves  $O(\sqrt{n})$  times  $O(n)$  steps. Thus, both endpoints move a total of  $O(n\sqrt{n})$  steps during the algorithm.

## Example

As an example, consider a problem where we are given a set of queries, each of them corresponding to a range in an array, and our task is to calculate for each query the number of *distinct* elements in the range.

In Mo's algorithm, the queries are always sorted in the same way, but it depends on the problem how the answer to the query is maintained. In this problem, we can maintain an array count where  $\text{count}[x]$  indicates the number of times an element  $x$  occurs in the active range.

When we move from one query to another query, the active range changes. For example, if the current range is

|   |   |   |   |   |   |   |   |   |
|---|---|---|---|---|---|---|---|---|
| 4 | 2 | 5 | 4 | 2 | 4 | 3 | 3 | 4 |
|---|---|---|---|---|---|---|---|---|

and the next range is

|   |   |   |   |   |   |   |   |   |
|---|---|---|---|---|---|---|---|---|
| 4 | 2 | 5 | 4 | 2 | 4 | 3 | 3 | 4 |
|---|---|---|---|---|---|---|---|---|

there will be three steps: the left endpoint moves one step to the right, and the right endpoint moves two steps to the right.

After each step, the array count needs to be updated. After adding an element  $x$ , we increase the value of  $\text{count}[x]$  by 1, and if  $\text{count}[x] = 1$  after this, we also increase the answer to the query by 1. Similarly, after removing an element  $x$ , we decrease the value of  $\text{count}[x]$  by 1, and if  $\text{count}[x] = 0$  after this, we also decrease the answer to the query by 1.

In this problem, the time needed to perform each step is  $O(1)$ , so the total time complexity of the algorithm is  $O(n\sqrt{n})$ .

# Chapter 28

## Segment trees revisited

A segment tree is a versatile data structure that can be used to solve a large number of algorithm problems. However, there are many topics related to segment trees that we have not touched yet. Now is time to discuss some more advanced variants of segment trees.

So far, we have implemented the operations of a segment tree by walking *from bottom to top* in the tree. For example, we have calculated range sums as follows (Chapter 9.3):

```
int sum(int a, int b) {
    a += n; b += n;
    int s = 0;
    while (a <= b) {
        if (a%2 == 1) s += tree[a++];
        if (b%2 == 0) s += tree[b--];
        a /= 2; b /= 2;
    }
    return s;
}
```

However, in more advanced segment trees, it is often necessary to implement the operations in another way, *from top to bottom*. Using this approach, the function becomes as follows:

```
int sum(int a, int b, int k, int x, int y) {
    if (b < x || a > y) return 0;
    if (a <= x && y <= b) return tree[k];
    int d = (x+y)/2;
    return sum(a,b,2*k,x,d) + sum(a,b,2*k+1,d+1,y);
}
```

Now we can calculate any value of  $\text{sum}_q(a, b)$  (the sum of array values in range  $[a, b]$ ) as follows:

```
int s = sum(a, b, 1, 0, n-1);
```

The parameter  $k$  indicates the current position in tree. Initially  $k$  equals 1, because we begin at the root of the tree. The range  $[x, y]$  corresponds to  $k$  and is initially  $[0, n - 1]$ . When calculating the sum, if  $[x, y]$  is outside  $[a, b]$ , the sum is 0, and if  $[x, y]$  is completely inside  $[a, b]$ , the sum can be found in tree. If  $[x, y]$  is partially inside  $[a, b]$ , the search continues recursively to the left and right half of  $[x, y]$ . The left half is  $[x, d]$  and the right half is  $[d + 1, y]$  where  $d = \lfloor \frac{x+y}{2} \rfloor$ .

The following picture shows how the search proceeds when calculating the value of  $\text{sum}_q(a, b)$ . The gray nodes indicate nodes where the recursion stops and the sum can be found in tree.

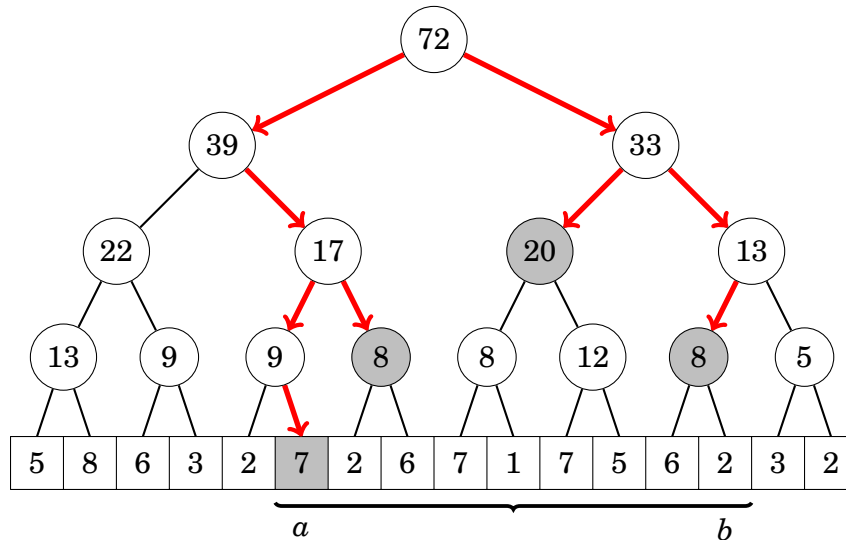

Also in this implementation, operations take  $O(\log n)$  time, because the total number of visited nodes is  $O(\log n)$ .

## 28.1 Lazy propagation

Using **lazy propagation**, we can build a segment tree that supports *both* range updates and range queries in  $O(\log n)$  time. The idea is to perform updates and queries from top to bottom and perform updates *lazily* so that they are propagated down the tree only when it is necessary.

In a lazy segment tree, nodes contain two types of information. Like in an ordinary segment tree, each node contains the sum or some other value related to the corresponding subarray. In addition, the node may contain information related to lazy updates, which has not been propagated to its children.

There are two types of range updates: each array value in the range is either *increased* by some value or *assigned* some value. Both operations can be implemented using similar ideas, and it is even possible to construct a tree that supports both operations at the same time.

### Lazy segment trees

Let us consider an example where our goal is to construct a segment tree that supports two operations: increasing each value in  $[a, b]$  by a constant and calculating

the sum of values in  $[a, b]$ .

We will construct a tree where each node has two values  $s/z$ :  $s$  denotes the sum of values in the range, and  $z$  denotes the value of a lazy update, which means that all values in the range should be increased by  $z$ . In the following tree,  $z = 0$  in all nodes, so there are no ongoing lazy updates.

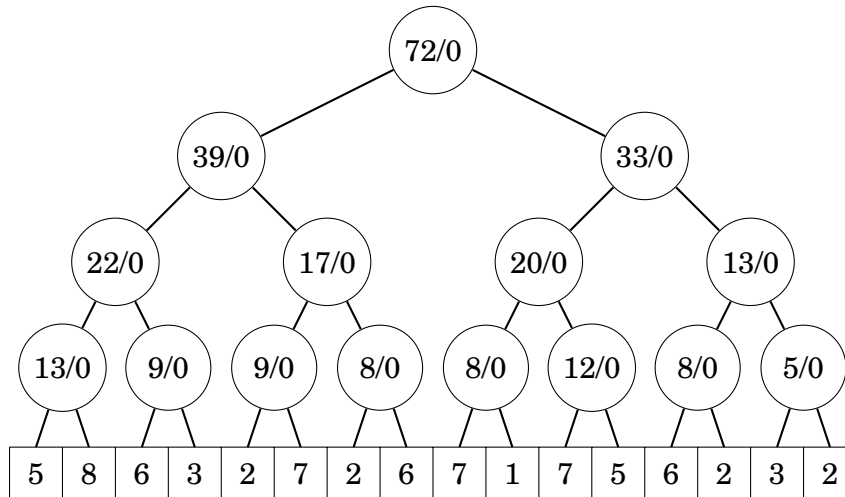

When the elements in  $[a, b]$  are increased by  $u$ , we walk from the root towards the leaves and modify the nodes of the tree as follows: If the range  $[x, y]$  of a node is completely inside  $[a, b]$ , we increase the  $z$  value of the node by  $u$  and stop. If  $[x, y]$  only partially belongs to  $[a, b]$ , we increase the  $s$  value of the node by  $hu$ , where  $h$  is the size of the intersection of  $[a, b]$  and  $[x, y]$ , and continue our walk recursively in the tree.

For example, the following picture shows the tree after increasing the elements in  $[a, b]$  by 2:

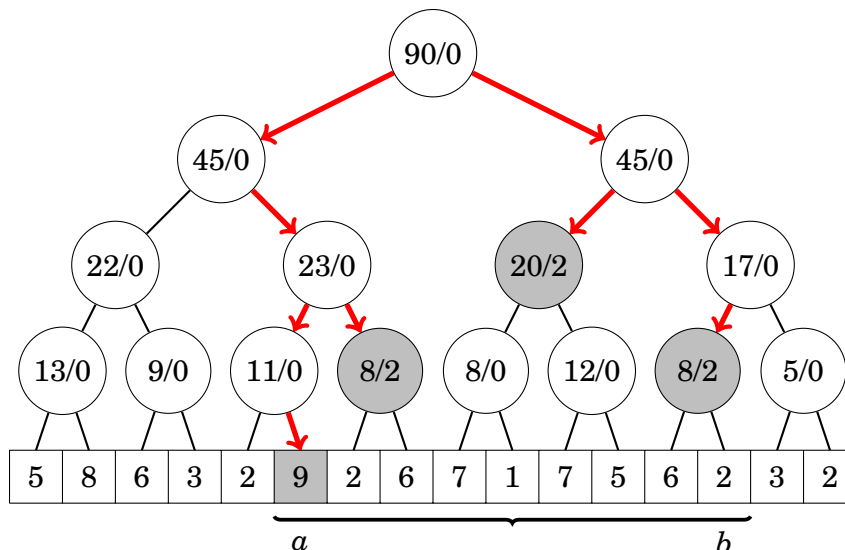

We also calculate the sum of elements in a range  $[a, b]$  by walking in the tree from top to bottom. If the range  $[x, y]$  of a node completely belongs to  $[a, b]$ , we add the  $s$  value of the node to the sum. Otherwise, we continue the search recursively downwards in the tree.

Both in updates and queries, the value of a lazy update is always propagated to the children of the node before processing the node. The idea is that updates will be propagated downwards only when it is necessary, which guarantees that the operations are always efficient.

The following picture shows how the tree changes when we calculate the value of  $\text{sum}_a(a, b)$ . The rectangle shows the nodes whose values change, because a lazy update is propagated downwards.

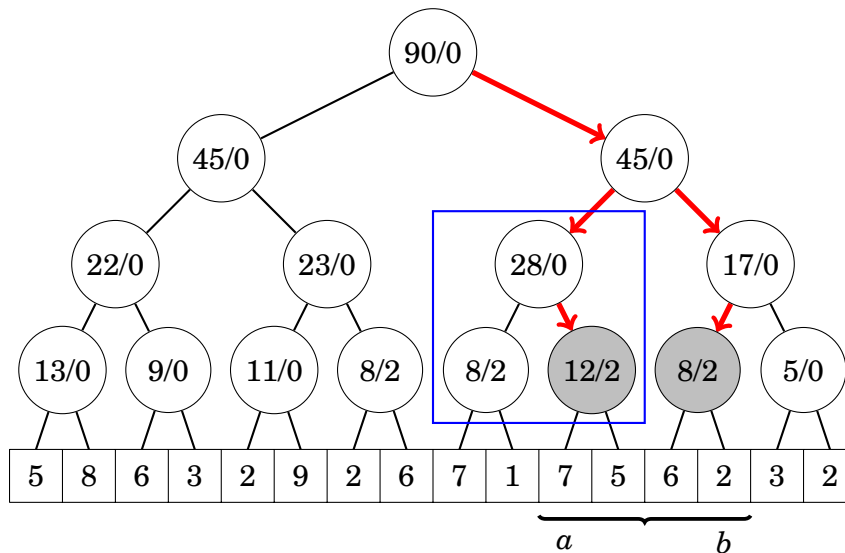

Note that sometimes it is needed to combine lazy updates. This happens when a node that already has a lazy update is assigned another lazy update. When calculating sums, it is easy to combine lazy updates, because the combination of updates  $z_1$  and  $z_2$  corresponds to an update  $z_1 + z_2$ .

## Polynomial updates

Lazy updates can be generalized so that it is possible to update ranges using polynomials of the form

$$p(u) = t_k u^k + t_{k-1} u^{k-1} + \dots + t_0.$$

In this case, the update for a value at position  $i$  in  $[a, b]$  is  $p(i - a)$ . For example, adding the polynomial  $p(u) = u + 1$  to  $[a, b]$  means that the value at position  $a$  increases by 1, the value at position  $a + 1$  increases by 2, and so on.

To support polynomial updates, each node is assigned  $k + 2$  values, where  $k$  equals the degree of the polynomial. The value  $s$  is the sum of the elements in the range, and the values  $z_0, z_1, \dots, z_k$  are the coefficients of a polynomial that corresponds to a lazy update.

Now, the sum of values in a range  $[x, y]$  equals

$$s + \sum_{u=0}^{y-x} z_k u^k + z_{k-1} u^{k-1} + \dots + z_0.$$

The value of such a sum can be efficiently calculated using sum formulas. For example, the term  $z_0$  corresponds to the sum  $(y - x + 1)z_0$ , and the term  $z_1 u$  corresponds to the sum

$$z_1(0 + 1 + \dots + y - x) = z_1 \frac{(y - x)(y - x + 1)}{2}.$$

When propagating an update in the tree, the indices of  $p(u)$  change, because in each range  $[x, y]$ , the values are calculated for  $u = 0, 1, \dots, y - x$ . However, this is not a problem, because  $p'(u) = p(u + h)$  is a polynomial of equal degree as  $p(u)$ . For example, if  $p(u) = t_2 u^2 + t_1 u - t_0$ , then

$$p'(u) = t_2(u + h)^2 + t_1(u + h) - t_0 = t_2 u^2 + (2ht_2 + t_1)u + t_2 h^2 + t_1 h - t_0.$$

## 28.2 Dynamic trees

An ordinary segment tree is static, which means that each node has a fixed position in the array and the tree requires a fixed amount of memory. In a **dynamic segment tree**, memory is allocated only for nodes that are actually accessed during the algorithm, which can save a large amount of memory.

The nodes of a dynamic tree can be represented as structs:

```
struct node {
    int value;
    int x, y;
    node *left, *right;
    node(int v, int x, int y) : value(v), x(x), y(y) {}
};
```

Here `value` is the value of the node, `[x, y]` is the corresponding range, and `left` and `right` point to the left and right subtree.

After this, nodes can be created as follows:

```
// create new node
node *x = new node(0, 0, 15);
// change value
x->value = 5;
```

### Sparse segment trees

A dynamic segment tree is useful when the underlying array is *sparse*, i.e., the range  $[0, n - 1]$  of allowed indices is large, but most array values are zeros. While an ordinary segment tree uses  $O(n)$  memory, a dynamic segment tree only uses  $O(k \log n)$  memory, where  $k$  is the number of operations performed.

A **sparse segment tree** initially has only one node  $[0, n - 1]$  whose value is zero, which means that every array value is zero. After updates, new nodes are dynamically added to the tree. For example, if  $n = 16$  and the elements in positions 3 and 10 have been modified, the tree contains the following nodes:

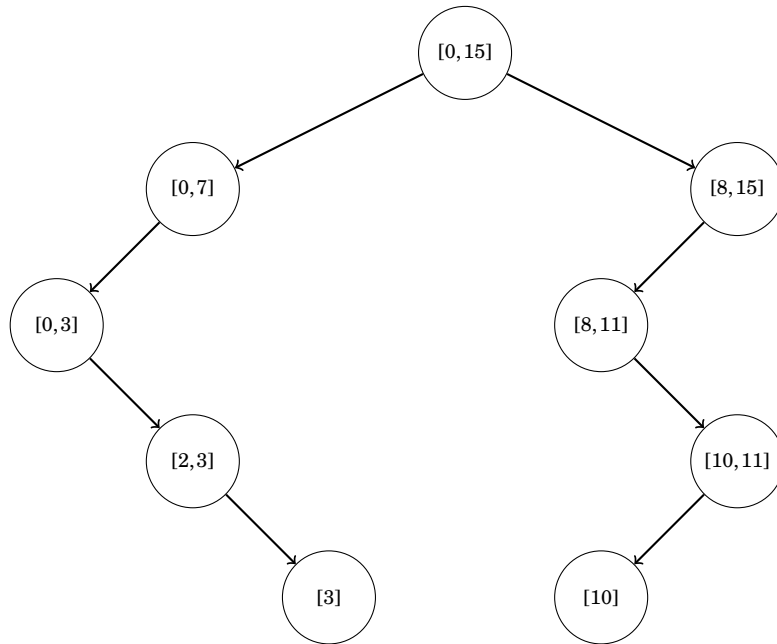

Any path from the root node to a leaf contains  $O(\log n)$  nodes, so each operation adds at most  $O(\log n)$  new nodes to the tree. Thus, after  $k$  operations, the tree contains at most  $O(k \log n)$  nodes.

Note that if we know all elements to be updated at the beginning of the algorithm, a dynamic segment tree is not necessary, because we can use an ordinary segment tree with index compression (Chapter 9.4). However, this is not possible when the indices are generated during the algorithm.

## Persistent segment trees

Using a dynamic implementation, it is also possible to create a **persistent segment tree** that stores the *modification history* of the tree. In such an implementation, we can efficiently access all versions of the tree that have existed during the algorithm.

When the modification history is available, we can perform queries in any previous tree like in an ordinary segment tree, because the full structure of each tree is stored. We can also create new trees based on previous trees and modify them independently.

Consider the following sequence of updates, where red nodes change and other nodes remain the same:

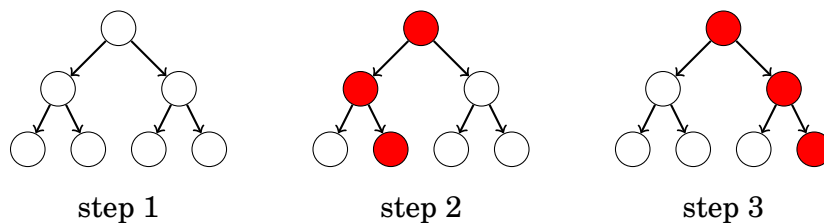

After each update, most nodes of the tree remain the same, so an efficient way to store the modification history is to represent each tree in the history as a



combination of new nodes and subtrees of previous trees. In this example, the modification history can be stored as follows:

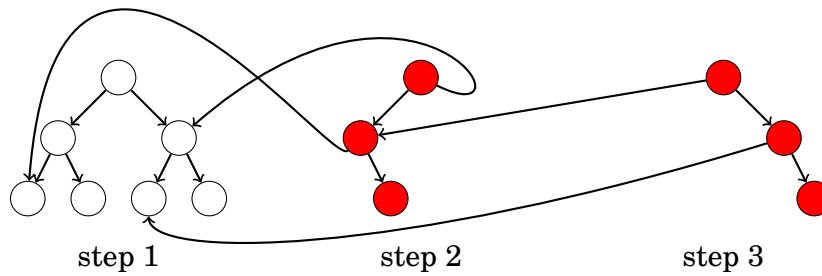

The structure of each previous tree can be reconstructed by following the pointers starting at the corresponding root node. Since each operation adds only  $O(\log n)$  new nodes to the tree, it is possible to store the full modification history of the tree.

### 28.3 Data structures

Instead of single values, nodes in a segment tree can also contain *data structures* that maintain information about the corresponding ranges. In such a tree, the operations take  $O(f(n)\log n)$  time, where  $f(n)$  is the time needed for processing a single node during an operation.

As an example, consider a segment tree that supports queries of the form "how many times does an element  $x$  appear in the range  $[a, b]$ ?" For example, the element 1 appears three times in the following range:

|   |   |   |   |   |   |   |   |
|---|---|---|---|---|---|---|---|
| 3 | 1 | 2 | 3 | 1 | 1 | 1 | 2 |
|---|---|---|---|---|---|---|---|

To support such queries, we build a segment tree where each node is assigned a data structure that can be asked how many times any element  $x$  appears in the corresponding range. Using this tree, the answer to a query can be calculated by combining the results from the nodes that belong to the range.

For example, the following segment tree corresponds to the above array:

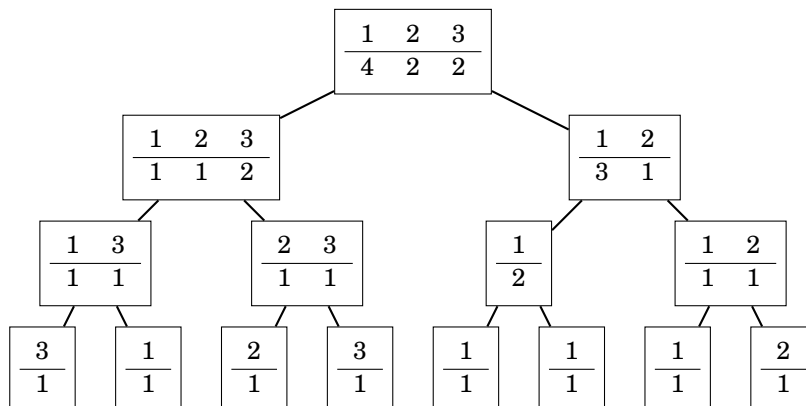

We can build the tree so that each node contains a map structure. In this case, the time needed for processing each node is  $O(\log n)$ , so the total time complexity of a query is  $O(\log^2 n)$ . The tree uses  $O(n \log n)$  memory, because there are  $O(\log n)$  levels and each level contains  $O(n)$  elements.

## 28.4 Two-dimensionality

A **two-dimensional segment tree** supports queries related to rectangular subarrays of a two-dimensional array. Such a tree can be implemented as nested segment trees: a big tree corresponds to the rows of the array, and each node contains a small tree that corresponds to a column.

For example, in the array

|   |   |   |   |
|---|---|---|---|
| 7 | 6 | 1 | 6 |
| 8 | 7 | 5 | 2 |
| 3 | 9 | 7 | 1 |
| 8 | 5 | 3 | 8 |

the sum of any subarray can be calculated from the following segment tree:

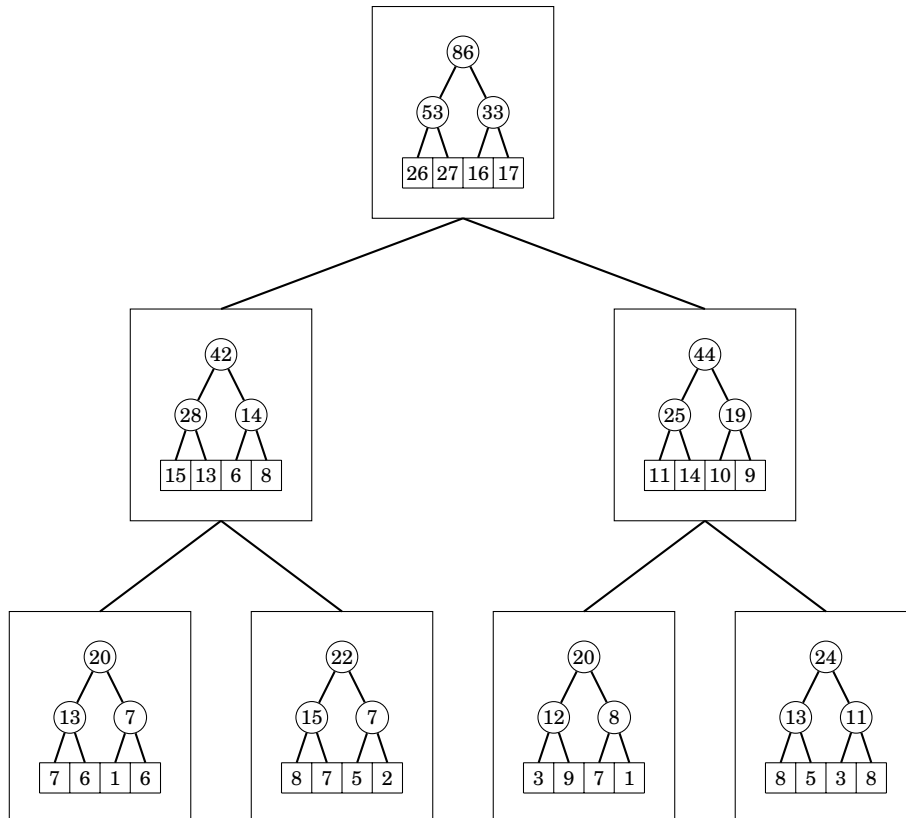

The operations of a two-dimensional segment tree take  $O(\log^2 n)$  time, because the big tree and each small tree consist of  $O(\log n)$  levels. The tree requires  $O(n^2)$  memory, because each small tree contains  $O(n)$  values.

# Chapter 29

## Geometry

In geometric problems, it is often challenging to find a way to approach the problem so that the solution to the problem can be conveniently implemented and the number of special cases is small.

As an example, consider a problem where we are given the vertices of a quadrilateral (a polygon that has four vertices), and our task is to calculate its area. For example, a possible input for the problem is as follows:

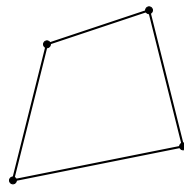

One way to approach the problem is to divide the quadrilateral into two triangles by a straight line between two opposite vertices:

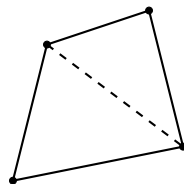

After this, it suffices to sum the areas of the triangles. The area of a triangle can be calculated, for example, using **Heron's formula**

$$\sqrt{s(s-a)(s-b)(s-c)},$$

where  $a$ ,  $b$  and  $c$  are the lengths of the triangle's sides and  $s = (a + b + c)/2$ .

This is a possible way to solve the problem, but there is one pitfall: how to divide the quadrilateral into triangles? It turns out that sometimes we cannot just pick two arbitrary opposite vertices. For example, in the following situation, the division line is *outside* the quadrilateral:

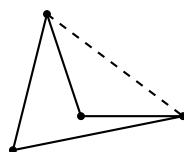

However, another way to draw the line works:

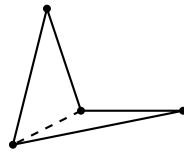

It is clear for a human which of the lines is the correct choice, but the situation is difficult for a computer.

However, it turns out that we can solve the problem using another method that is more convenient to a programmer. Namely, there is a general formula

$$x_1y_2 - x_2y_1 + x_2y_3 - x_3y_2 + x_3y_4 - x_4y_3 + x_4y_1 - x_1y_4,$$

that calculates the area of a quadrilateral whose vertices are  $(x_1, y_1)$ ,  $(x_2, y_2)$ ,  $(x_3, y_3)$  and  $(x_4, y_4)$ . This formula is easy to implement, there are no special cases, and we can even generalize the formula to *all* polygons.

## 29.1 Complex numbers

A **complex number** is a number of the form  $x + yi$ , where  $i = \sqrt{-1}$  is the **imaginary unit**. A geometric interpretation of a complex number is that it represents a two-dimensional point  $(x, y)$  or a vector from the origin to a point  $(x, y)$ .

For example,  $4 + 2i$  corresponds to the following point and vector:

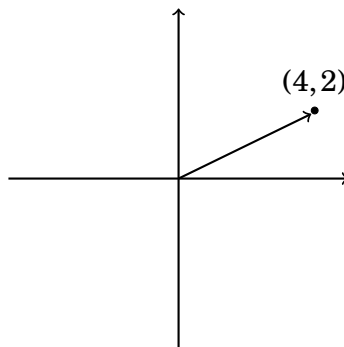

The C++ complex number class `complex` is useful when solving geometric problems. Using the class we can represent points and vectors as complex numbers, and the class contains tools that are useful in geometry.

In the following code, `C` is the type of a coordinate and `P` is the type of a point or a vector. In addition, the code defines macros `X` and `Y` that can be used to refer to `x` and `y` coordinates.

```
typedef long long C;  
typedef complex<C> P;  
#define X real()  
#define Y imag()
```

For example, the following code defines a point  $p = (4, 2)$  and prints its x and y coordinates:

```
P p = {4, 2};  
cout << p.X << " " << p.Y << "\n"; // 4 2
```

The following code defines vectors  $v = (3, 1)$  and  $u = (2, 2)$ , and after that calculates the sum  $s = v + u$ .

```
P v = {3, 1};  
P u = {2, 2};  
P s = v+u;  
cout << s.X << " " << s.Y << "\n"; // 5 3
```

In practice, an appropriate coordinate type is usually `long` (integer) or `long double` (real number). It is a good idea to use integer whenever possible, because calculations with integers are exact. If real numbers are needed, precision errors should be taken into account when comparing numbers. A safe way to check if real numbers  $a$  and  $b$  are equal is to compare them using  $|a - b| < \epsilon$ , where  $\epsilon$  is a small number (for example,  $\epsilon = 10^{-9}$ ).

## Functions

In the following examples, the coordinate type is `long double`.

The function `abs(v)` calculates the length  $|v|$  of a vector  $v = (x, y)$  using the formula  $\sqrt{x^2 + y^2}$ . The function can also be used for calculating the distance between points  $(x_1, y_1)$  and  $(x_2, y_2)$ , because that distance equals the length of the vector  $(x_2 - x_1, y_2 - y_1)$ .

The following code calculates the distance between points  $(4, 2)$  and  $(3, -1)$ :

```
P a = {4, 2};  
P b = {3, -1};  
cout << abs(b-a) << "\n"; // 3.16228
```

The function `arg(v)` calculates the angle of a vector  $v = (x, y)$  with respect to the x axis. The function gives the angle in radians, where  $r$  radians equals  $180r/\pi$  degrees. The angle of a vector that points to the right is 0, and angles decrease clockwise and increase counterclockwise.

The function `polar(s, a)` constructs a vector whose length is  $s$  and that points to an angle  $a$ . A vector can be rotated by an angle  $a$  by multiplying it by a vector with length 1 and angle  $a$ .

The following code calculates the angle of the vector  $(4, 2)$ , rotates it  $1/2$  radians counterclockwise, and then calculates the angle again:

```
P v = {4, 2};  
cout << arg(v) << "\n"; // 0.463648  
v *= polar(1.0, 0.5);  
cout << arg(v) << "\n"; // 0.963648
```

## 29.2 Points and lines

The **cross product**  $a \times b$  of vectors  $a = (x_1, y_1)$  and  $b = (x_2, y_2)$  is calculated using the formula  $x_1y_2 - x_2y_1$ . The cross product tells us whether  $b$  turns left (positive value), does not turn (zero) or turns right (negative value) when it is placed directly after  $a$ .

The following picture illustrates the above cases:

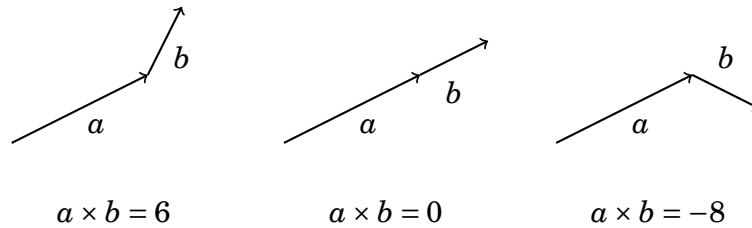

For example, in the first case  $a = (4, 2)$  and  $b = (1, 2)$ . The following code calculates the cross product using the class `complex`:

```
P a = {4, 2};  
P b = {1, 2};  
C p = (conj(a)*b).Y; // 6
```

The above code works, because the function `conj` negates the  $y$  coordinate of a vector, and when the vectors  $(x_1, -y_1)$  and  $(x_2, y_2)$  are multiplied together, the  $y$  coordinate of the result is  $x_1y_2 - x_2y_1$ .

### Point location

Cross products can be used to test whether a point is located on the left or right side of a line. Assume that the line goes through points  $s_1$  and  $s_2$ , we are looking from  $s_1$  to  $s_2$  and the point is  $p$ .

For example, in the following picture,  $p$  is on the left side of the line:

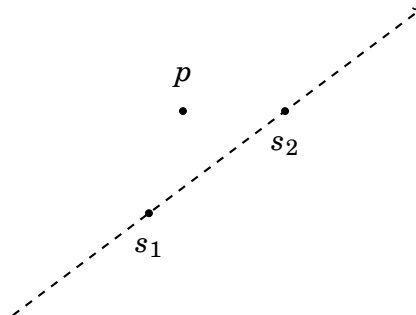

The cross product  $(p - s_1) \times (p - s_2)$  tells us the location of the point  $p$ . If the cross product is positive,  $p$  is located on the left side, and if the cross product is negative,  $p$  is located on the right side. Finally, if the cross product is zero, points  $s_1$ ,  $s_2$  and  $p$  are on the same line.

## Line segment intersection

Next we consider the problem of testing whether two line segments  $ab$  and  $cd$  intersect. The possible cases are:

*Case 1:* The line segments are on the same line and they overlap each other. In this case, there is an infinite number of intersection points. For example, in the following picture, all points between  $c$  and  $b$  are intersection points:

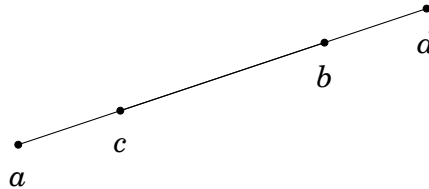

In this case, we can use cross products to check if all points are on the same line. After this, we can sort the points and check whether the line segments overlap each other.

*Case 2:* The line segments have a common vertex that is the only intersection point. For example, in the following picture the intersection point is  $b = c$ :

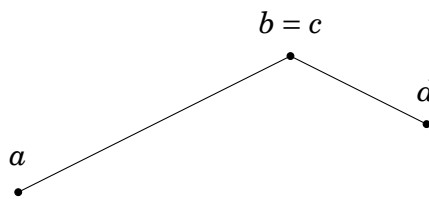

This case is easy to check, because there are only four possibilities for the intersection point:  $a = c$ ,  $a = d$ ,  $b = c$  and  $b = d$ .

*Case 3:* There is exactly one intersection point that is not a vertex of any line segment. In the following picture, the point  $p$  is the intersection point:

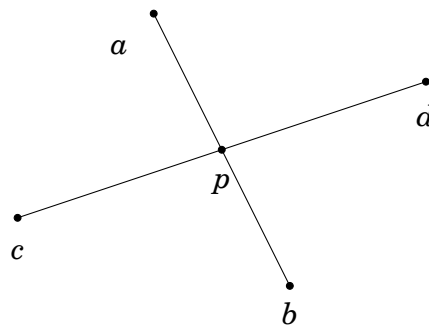

In this case, the line segments intersect exactly when both points  $c$  and  $d$  are on different sides of a line through  $a$  and  $b$ , and points  $a$  and  $b$  are on different sides of a line through  $c$  and  $d$ . We can use cross products to check this.

## Point distance from a line

Another feature of cross products is that the area of a triangle can be calculated using the formula

$$\frac{|(a - c) \times (b - c)|}{2},$$

where  $a$ ,  $b$  and  $c$  are the vertices of the triangle. Using this fact, we can derive a formula for calculating the shortest distance between a point and a line. For example, in the following picture  $d$  is the shortest distance between the point  $p$  and the line that is defined by the points  $s_1$  and  $s_2$ :

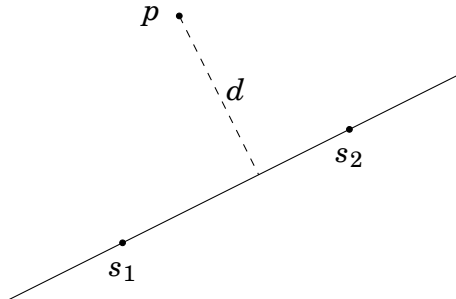

The area of the triangle whose vertices are  $s_1$ ,  $s_2$  and  $p$  can be calculated in two ways: it is both  $\frac{1}{2}|s_2 - s_1|d$  and  $\frac{1}{2}((s_1 - p) \times (s_2 - p))$ . Thus, the shortest distance is

$$d = \frac{(s_1 - p) \times (s_2 - p)}{|s_2 - s_1|}.$$

## Point inside a polygon

Let us now consider the problem of testing whether a point is located inside or outside a polygon. For example, in the following picture point  $a$  is inside the polygon and point  $b$  is outside the polygon.

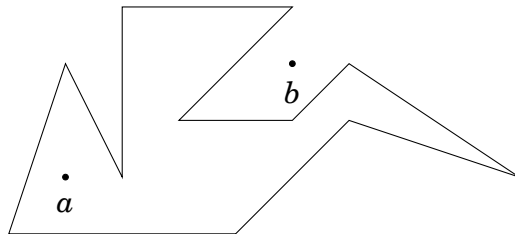

A convenient way to solve the problem is to send a *ray* from the point to an arbitrary direction and calculate the number of times it touches the boundary of the polygon. If the number is odd, the point is inside the polygon, and if the number is even, the point is outside the polygon.

For example, we could send the following rays:

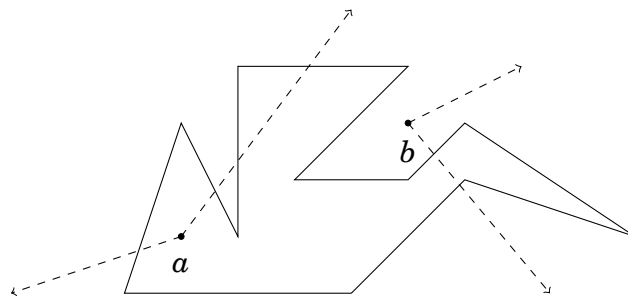

The rays from  $a$  touch 1 and 3 times the boundary of the polygon, so  $a$  is inside the polygon. Correspondingly, the rays from  $b$  touch 0 and 2 times the boundary of the polygon, so  $b$  is outside the polygon.



## 29.3 Polygon area

A general formula for calculating the area of a polygon, sometimes called the **shoelace formula**, is as follows:

$$\frac{1}{2} \left| \sum_{i=1}^{n-1} (p_i \times p_{i+1}) \right| = \frac{1}{2} \left| \sum_{i=1}^{n-1} (x_i y_{i+1} - x_{i+1} y_i) \right|,$$

Here the vertices are  $p_1 = (x_1, y_1)$ ,  $p_2 = (x_2, y_2)$ , ...,  $p_n = (x_n, y_n)$  in such an order that  $p_i$  and  $p_{i+1}$  are adjacent vertices on the boundary of the polygon, and the first and last vertex is the same, i.e.,  $p_1 = p_n$ .

For example, the area of the polygon

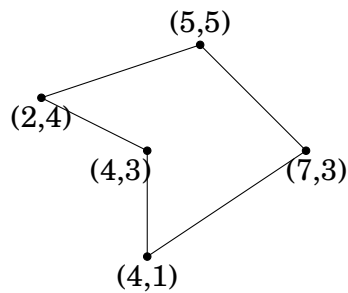

is

$$\frac{|(2 \cdot 5 - 5 \cdot 4) + (5 \cdot 3 - 7 \cdot 5) + (7 \cdot 1 - 4 \cdot 3) + (4 \cdot 3 - 4 \cdot 1) + (4 \cdot 4 - 2 \cdot 3)|}{2} = 17/2.$$

The idea of the formula is to go through trapezoids whose one side is a side of the polygon, and another side lies on the horizontal line  $y = 0$ . For example:

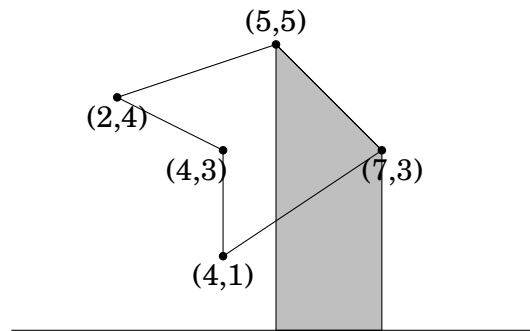

The area of such a trapezoid is

$$(x_{i+1} - x_i) \frac{y_i + y_{i+1}}{2},$$

where the vertices of the polygon are  $p_i$  and  $p_{i+1}$ . If  $x_{i+1} > x_i$ , the area is positive, and if  $x_{i+1} < x_i$ , the area is negative.

The area of the polygon is the sum of areas of all such trapezoids, which yields the formula

$$\left| \sum_{i=1}^{n-1} (x_{i+1} - x_i) \frac{y_i + y_{i+1}}{2} \right| = \frac{1}{2} \left| \sum_{i=1}^{n-1} (x_i y_{i+1} - x_{i+1} y_i) \right|.$$

Note that the absolute value of the sum is taken, because the value of the sum may be positive or negative, depending on whether we walk clockwise or counterclockwise along the boundary of the polygon.

## Pick's theorem

**Pick's theorem** provides another way to calculate the area of a polygon provided that all vertices of the polygon have integer coordinates. According to Pick's theorem, the area of the polygon is

$$a + b/2 - 1,$$

where  $a$  is the number of integer points inside the polygon and  $b$  is the number of integer points on the boundary of the polygon.

For example, the area of the polygon

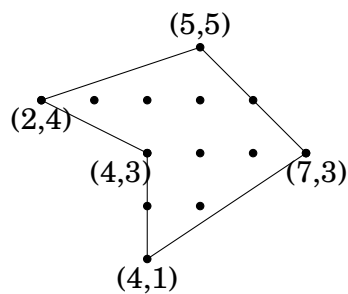

is  $6 + 7/2 - 1 = 17/2$ .

## 29.4 Distance functions

A **distance function** defines the distance between two points. The usual distance function is the **Euclidean distance** where the distance between points  $(x_1, y_1)$  and  $(x_2, y_2)$  is

$$\sqrt{(x_2 - x_1)^2 + (y_2 - y_1)^2}.$$

An alternative distance function is the **Manhattan distance** where the distance between points  $(x_1, y_1)$  and  $(x_2, y_2)$  is

$$|x_1 - x_2| + |y_1 - y_2|.$$

For example, consider the following picture:

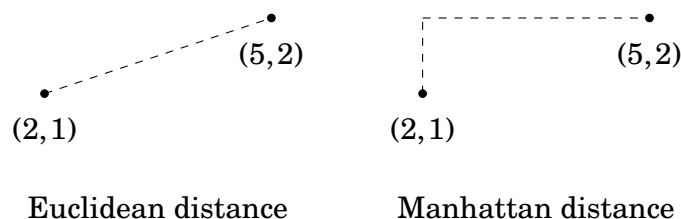

The Euclidean distance between the points is

$$\sqrt{(5 - 2)^2 + (2 - 1)^2} = \sqrt{10}$$

and the Manhattan distance is

$$|5 - 2| + |2 - 1| = 4.$$

The following picture shows regions that are within a distance of 1 from the center point, using the Euclidean and Manhattan distances:

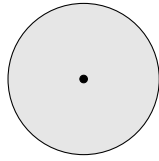

Euclidean distance

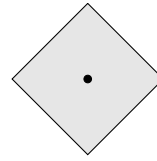

Manhattan distance

## Rotating coordinates

Some problems are easier to solve if Manhattan distances are used instead of Euclidean distances. As an example, consider a problem where we are given  $n$  points in the two-dimensional plane and our task is to calculate the maximum Manhattan distance between any two points.

For example, consider the following set of points:

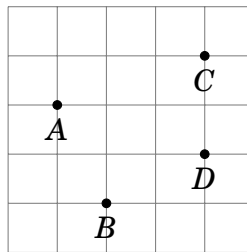

The maximum Manhattan distance is 5 between points  $B$  and  $C$ :

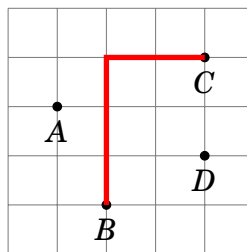

A useful technique related to Manhattan distances is to rotate all coordinates 45 degrees so that a point  $(x, y)$  becomes  $(x + y, y - x)$ . For example, after rotating the above points, the result is:

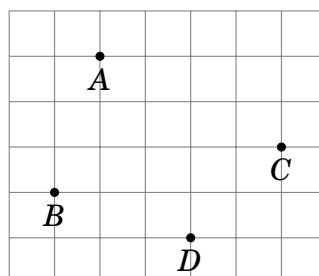

And the maximum distance is as follows:

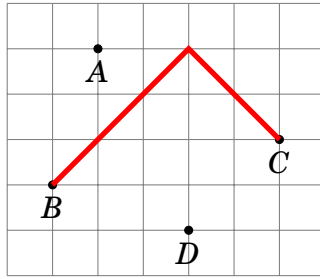

Consider two points  $p_1 = (x_1, y_1)$  and  $p_2 = (x_2, y_2)$  whose rotated coordinates are  $p'_1 = (x'_1, y'_1)$  and  $p'_2 = (x'_2, y'_2)$ . Now there are two ways to express the Manhattan distance between  $p_1$  and  $p_2$ :

$$|x_1 - x_2| + |y_1 - y_2| = \max(|x'_1 - x'_2|, |y'_1 - y'_2|)$$

For example, if  $p_1 = (1, 0)$  and  $p_2 = (3, 3)$ , the rotated coordinates are  $p'_1 = (1, -1)$  and  $p'_2 = (6, 0)$  and the Manhattan distance is

$$|1 - 3| + |0 - 3| = \max(|1 - 6|, |-1 - 0|) = 5.$$

The rotated coordinates provide a simple way to operate with Manhattan distances, because we can consider x and y coordinates separately. To maximize the Manhattan distance between two points, we should find two points whose rotated coordinates maximize the value of

$$\max(|x'_1 - x'_2|, |y'_1 - y'_2|).$$

This is easy, because either the horizontal or vertical difference of the rotated coordinates has to be maximum.

# Chapter 30

## Sweep line algorithms

Many geometric problems can be solved using **sweep line** algorithms. The idea in such algorithms is to represent an instance of the problem as a set of events that correspond to points in the plane. The events are processed in increasing order according to their  $x$  or  $y$  coordinates.

As an example, consider the following problem: There is a company that has  $n$  employees, and we know for each employee their arrival and leaving times on a certain day. Our task is to calculate the maximum number of employees that were in the office at the same time.

The problem can be solved by modeling the situation so that each employee is assigned two events that correspond to their arrival and leaving times. After sorting the events, we go through them and keep track of the number of people in the office. For example, the table

| person | arrival time | leaving time |
|--------|--------------|--------------|
| John   | 10           | 15           |
| Maria  | 6            | 12           |
| Peter  | 14           | 16           |
| Lisa   | 5            | 13           |

corresponds to the following events:

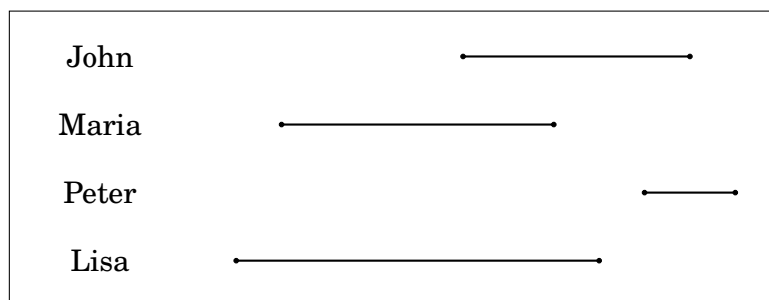

We go through the events from left to right and maintain a counter. Always when a person arrives, we increase the value of the counter by one, and when a person leaves, we decrease the value of the counter by one. The answer to the problem is the maximum value of the counter during the algorithm.

In the example, the events are processed as follows:

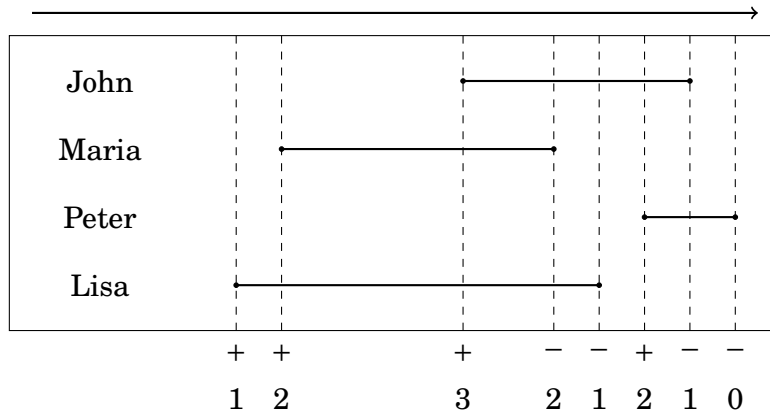

The symbols + and - indicate whether the value of the counter increases or decreases, and the value of the counter is shown below. The maximum value of the counter is 3 between John's arrival and Maria's leaving.

The running time of the algorithm is  $O(n \log n)$ , because sorting the events takes  $O(n \log n)$  time and the rest of the algorithm takes  $O(n)$  time.

### 30.1 Intersection points

Given a set of  $n$  line segments, each of them being either horizontal or vertical, consider the problem of counting the total number of intersection points. For example, when the line segments are

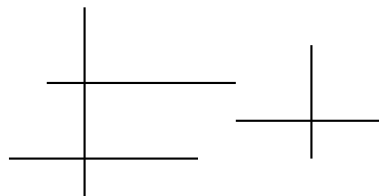

there are three intersection points:

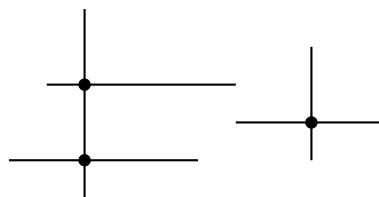

It is easy to solve the problem in  $O(n^2)$  time, because we can go through all possible pairs of line segments and check if they intersect. However, we can solve the problem more efficiently in  $O(n \log n)$  time using a sweep line algorithm and a range query data structure.

The idea is to process the endpoints of the line segments from left to right and focus on three types of events:

- (1) horizontal segment begins
- (2) horizontal segment ends
- (3) vertical segment

The following events correspond to the example:

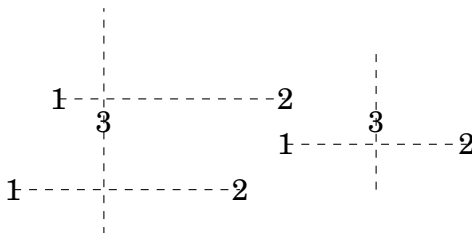

We go through the events from left to right and use a data structure that maintains a set of  $y$  coordinates where there is an active horizontal segment. At event 1, we add the  $y$  coordinate of the segment to the set, and at event 2, we remove the  $y$  coordinate from the set.

Intersection points are calculated at event 3. When there is a vertical segment between points  $y_1$  and  $y_2$ , we count the number of active horizontal segments whose  $y$  coordinate is between  $y_1$  and  $y_2$ , and add this number to the total number of intersection points.

To store  $y$  coordinates of horizontal segments, we can use a binary indexed or segment tree, possibly with index compression. When such structures are used, processing each event takes  $O(\log n)$  time, so the total running time of the algorithm is  $O(n \log n)$ .

## 30.2 Closest pair problem

Given a set of  $n$  points, our next problem is to find two points whose Euclidean distance is minimum. For example, if the points are

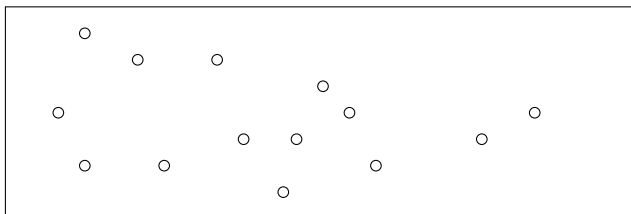

we should find the following points:

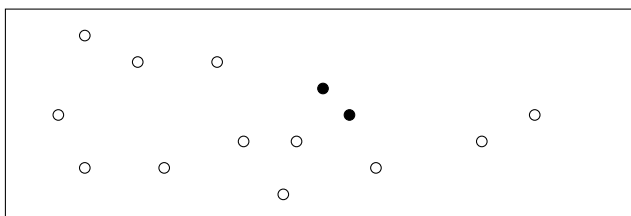

This is another example of a problem that can be solved in  $O(n \log n)$  time using a sweep line algorithm<sup>1</sup>. We go through the points from left to right and maintain a value  $d$ : the minimum distance between two points seen so far. At

<sup>1</sup>Besides this approach, there is also an  $O(n \log n)$  time divide-and-conquer algorithm [57] that divides the points into two sets and recursively solves the problem for both sets.

each point, we find the nearest point to the left. If the distance is less than  $d$ , it is the new minimum distance and we update the value of  $d$ .

If the current point is  $(x, y)$  and there is a point to the left within a distance of less than  $d$ , the  $x$  coordinate of such a point must be between  $[x - d, x]$  and the  $y$  coordinate must be between  $[y - d, y + d]$ . Thus, it suffices to only consider points that are located in those ranges, which makes the algorithm efficient.

For example, in the following picture, the region marked with dashed lines contains the points that can be within a distance of  $d$  from the active point:

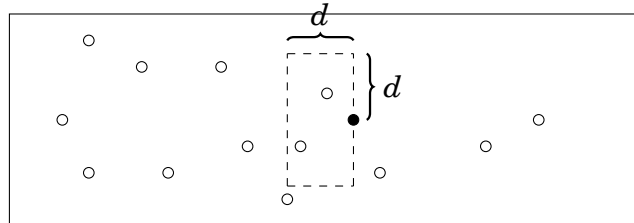

The efficiency of the algorithm is based on the fact that the region always contains only  $O(1)$  points. We can go through those points in  $O(\log n)$  time by maintaining a set of points whose  $x$  coordinate is between  $[x - d, x]$ , in increasing order according to their  $y$  coordinates.

The time complexity of the algorithm is  $O(n \log n)$ , because we go through  $n$  points and find for each point the nearest point to the left in  $O(\log n)$  time.

### 30.3 Convex hull problem

A **convex hull** is the smallest convex polygon that contains all points of a given set. Convexity means that a line segment between any two vertices of the polygon is completely inside the polygon.

For example, for the points

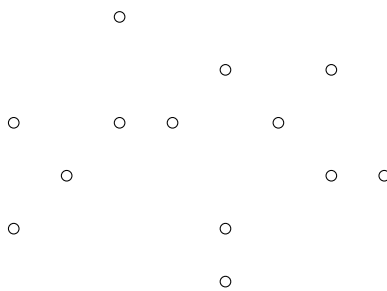

the convex hull is as follows:

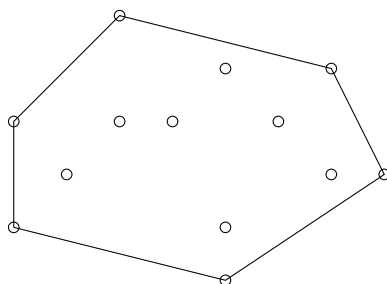



**Andrew's algorithm** [3] provides an easy way to construct the convex hull for a set of points in  $O(n \log n)$  time. The algorithm first locates the leftmost and rightmost points, and then constructs the convex hull in two parts: first the upper hull and then the lower hull. Both parts are similar, so we can focus on constructing the upper hull.

First, we sort the points primarily according to x coordinates and secondarily according to y coordinates. After this, we go through the points and add each point to the hull. Always after adding a point to the hull, we make sure that the last line segment in the hull does not turn left. As long as it turns left, we repeatedly remove the second last point from the hull.

The following pictures show how Andrew's algorithm works:

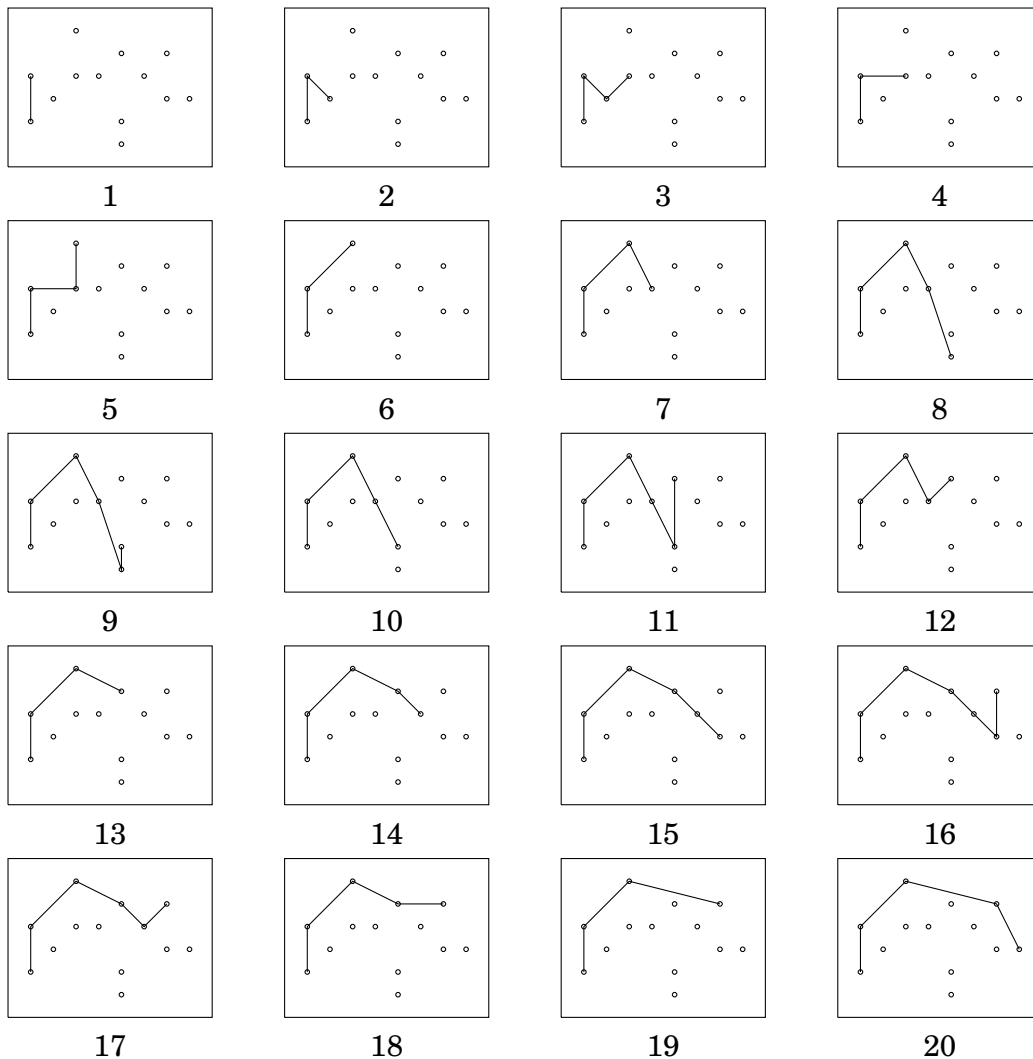



# Bibliography

- [1] A. V. Aho, J. E. Hopcroft and J. Ullman. *Data Structures and Algorithms*, Addison-Wesley, 1983.
- [2] R. K. Ahuja and J. B. Orlin. Distance directed augmenting path algorithms for maximum flow and parametric maximum flow problems. *Naval Research Logistics*, 38(3):413–430, 1991.
- [3] A. M. Andrew. Another efficient algorithm for convex hulls in two dimensions. *Information Processing Letters*, 9(5):216–219, 1979.
- [4] B. Aspvall, M. F. Plass and R. E. Tarjan. A linear-time algorithm for testing the truth of certain quantified boolean formulas. *Information Processing Letters*, 8(3):121–123, 1979.
- [5] R. Bellman. On a routing problem. *Quarterly of Applied Mathematics*, 16(1):87–90, 1958.
- [6] M. Beck, E. Pine, W. Tarrat and K. Y. Jensen. New integer representations as the sum of three cubes. *Mathematics of Computation*, 76(259):1683–1690, 2007.
- [7] M. A. Bender and M. Farach-Colton. The LCA problem revisited. In *Latin American Symposium on Theoretical Informatics*, 88–94, 2000.
- [8] J. Bentley. *Programming Pearls*. Addison-Wesley, 1999 (2nd edition).
- [9] J. Bentley and D. Wood. An optimal worst case algorithm for reporting intersections of rectangles. *IEEE Transactions on Computers*, C-29(7):571–577, 1980.
- [10] C. L. Bouton. Nim, a game with a complete mathematical theory. *Annals of Mathematics*, 3(1/4):35–39, 1901.
- [11] Croatian Open Competition in Informatics, <http://hsin.hr/coci/>
- [12] Codeforces: On "Mo's algorithm", <http://codeforces.com/blog/entry/20032>
- [13] T. H. Cormen, C. E. Leiserson, R. L. Rivest and C. Stein. *Introduction to Algorithms*, MIT Press, 2009 (3rd edition).

- [14] E. W. Dijkstra. A note on two problems in connexion with graphs. *Numerische Mathematik*, 1(1):269–271, 1959.
- [15] K. Diks et al. *Looking for a Challenge? The Ultimate Problem Set from the University of Warsaw Programming Competitions*, University of Warsaw, 2012.
- [16] M. Dima and R. Ceterchi. Efficient range minimum queries using binary indexed trees. *Olympiad in Informatics*, 9(1):39–44, 2015.
- [17] J. Edmonds. Paths, trees, and flowers. *Canadian Journal of Mathematics*, 17(3):449–467, 1965.
- [18] J. Edmonds and R. M. Karp. Theoretical improvements in algorithmic efficiency for network flow problems. *Journal of the ACM*, 19(2):248–264, 1972.
- [19] S. Even, A. Itai and A. Shamir. On the complexity of time table and multi-commodity flow problems. *16th Annual Symposium on Foundations of Computer Science*, 184–193, 1975.
- [20] D. Fanding. A faster algorithm for shortest-path – SPFA. *Journal of Southwest Jiaotong University*, 2, 1994.
- [21] P. M. Fenwick. A new data structure for cumulative frequency tables. *Software: Practice and Experience*, 24(3):327–336, 1994.
- [22] J. Fischer and V. Heun. Theoretical and practical improvements on the RMQ-problem, with applications to LCA and LCE. In *Annual Symposium on Combinatorial Pattern Matching*, 36–48, 2006.
- [23] R. W. Floyd Algorithm 97: shortest path. *Communications of the ACM*, 5(6):345, 1962.
- [24] L. R. Ford. *Network flow theory*. RAND Corporation, Santa Monica, California, 1956.
- [25] L. R. Ford and D. R. Fulkerson. Maximal flow through a network. *Canadian Journal of Mathematics*, 8(3):399–404, 1956.
- [26] R. Freivalds. Probabilistic machines can use less running time. In *IFIP congress*, 839–842, 1977.
- [27] F. Le Gall. Powers of tensors and fast matrix multiplication. In *Proceedings of the 39th International Symposium on Symbolic and Algebraic Computation*, 296–303, 2014.
- [28] M. R. Garey and D. S. Johnson. *Computers and Intractability: A Guide to the Theory of NP-Completeness*, W. H. Freeman and Company, 1979.
- [29] Google Code Jam Statistics (2017), <https://www.go-hero.net/jam/17>

- [30] A. Grønlund and S. Pettie. Threesomes, degenerates, and love triangles. In *Proceedings of the 55th Annual Symposium on Foundations of Computer Science*, 621–630, 2014.
- [31] P. M. Grundy. Mathematics and games. *Eureka*, 2(5):6–8, 1939.
- [32] D. Gusfield. *Algorithms on Strings, Trees and Sequences: Computer Science and Computational Biology*, Cambridge University Press, 1997.
- [33] S. Halim and F. Halim. *Competitive Programming 3: The New Lower Bound of Programming Contests*, 2013.
- [34] M. Held and R. M. Karp. A dynamic programming approach to sequencing problems. *Journal of the Society for Industrial and Applied Mathematics*, 10(1):196–210, 1962.
- [35] C. Hierholzer and C. Wiener. Über die Möglichkeit, einen Linienzug ohne Wiederholung und ohne Unterbrechung zu umfahren. *Mathematische Annalen*, 6(1), 30–32, 1873.
- [36] C. A. R. Hoare. Algorithm 64: Quicksort. *Communications of the ACM*, 4(7):321, 1961.
- [37] C. A. R. Hoare. Algorithm 65: Find. *Communications of the ACM*, 4(7):321–322, 1961.
- [38] J. E. Hopcroft and J. D. Ullman. A linear list merging algorithm. Technical report, Cornell University, 1971.
- [39] E. Horowitz and S. Sahni. Computing partitions with applications to the knapsack problem. *Journal of the ACM*, 21(2):277–292, 1974.
- [40] D. A. Huffman. A method for the construction of minimum-redundancy codes. *Proceedings of the IRE*, 40(9):1098–1101, 1952.
- [41] The International Olympiad in Informatics Syllabus, <https://people.ksp.sk/~misof/ioi-syllabus/>
- [42] R. M. Karp and M. O. Rabin. Efficient randomized pattern-matching algorithms. *IBM Journal of Research and Development*, 31(2):249–260, 1987.
- [43] P. W. Kasteleyn. The statistics of dimers on a lattice: I. The number of dimer arrangements on a quadratic lattice. *Physica*, 27(12):1209–1225, 1961.
- [44] C. Kent, G. M. Landau and M. Ziv-Ukelson. On the complexity of sparse exon assembly. *Journal of Computational Biology*, 13(5):1013–1027, 2006.
- [45] J. Kleinberg and É. Tardos. *Algorithm Design*, Pearson, 2005.
- [46] D. E. Knuth. *The Art of Computer Programming. Volume 2: Seminumerical Algorithms*, Addison–Wesley, 1998 (3rd edition).

- [47] D. E. Knuth. *The Art of Computer Programming. Volume 3: Sorting and Searching*, Addison–Wesley, 1998 (2nd edition).
- [48] J. B. Kruskal. On the shortest spanning subtree of a graph and the traveling salesman problem. *Proceedings of the American Mathematical Society*, 7(1):48–50, 1956.
- [49] V. I. Levenshtein. Binary codes capable of correcting deletions, insertions, and reversals. *Soviet physics doklady*, 10(8):707–710, 1966.
- [50] M. G. Main and R. J. Lorentz. An  $O(n \log n)$  algorithm for finding all repetitions in a string. *Journal of Algorithms*, 5(3):422–432, 1984.
- [51] Młodzieżowa Akademia Informatyczna (MAIN), <http://main.edu.pl/>
- [52] J. Pachocki and J. Radoszewski. Where to use and how not to use polynomial string hashing. *Olympiads in Informatics*, 7(1):90–100, 2013.
- [53] I. Parberry. An efficient algorithm for the Knight’s tour problem. *Discrete Applied Mathematics*, 73(3):251–260, 1997.
- [54] D. Pearson. A polynomial-time algorithm for the change-making problem. *Operations Research Letters*, 33(3):231–234, 2005.
- [55] R. C. Prim. Shortest connection networks and some generalizations. *Bell System Technical Journal*, 36(6):1389–1401, 1957.
- [56] 27-Queens Puzzle: Massively Parallel Enumeration and Solution Counting. <https://github.com/preusser/q27>
- [57] M. I. Shamos and D. Hoey. Closest-point problems. In *Proceedings of the 16th Annual Symposium on Foundations of Computer Science*, 151–162, 1975.
- [58] M. Sharir. A strong-connectivity algorithm and its applications in data flow analysis. *Computers & Mathematics with Applications*, 7(1):67–72, 1981.
- [59] S. S. Skiena. *The Algorithm Design Manual*, Springer, 2008 (2nd edition).
- [60] S. S. Skiena and M. A. Revilla. *Programming Challenges: The Programming Contest Training Manual*, Springer, 2003.
- [61] R. Sprague. Über mathematische Kampfspiele. *Tohoku Mathematical Journal*, 41:438–444, 1935.
- [62] P. Stańczyk. *Algorytmika praktyczna w konkursach Informatycznych*, MSc thesis, University of Warsaw, 2006.
- [63] V. Strassen. Gaussian elimination is not optimal. *Numerische Mathematik*, 13(4):354–356, 1969.
- [64] R. E. Tarjan. Efficiency of a good but not linear set union algorithm. *Journal of the ACM*, 22(2):215–225, 1975.

- [65] R. E. Tarjan. Applications of path compression on balanced trees. *Journal of the ACM*, 26(4):690–715, 1979.
- [66] R. E. Tarjan and U. Vishkin. Finding biconnected components and computing tree functions in logarithmic parallel time. In *Proceedings of the 25th Annual Symposium on Foundations of Computer Science*, 12–20, 1984.
- [67] H. N. V. Temperley and M. E. Fisher. Dimer problem in statistical mechanics – an exact result. *Philosophical Magazine*, 6(68):1061–1063, 1961.
- [68] USA Computing Olympiad, <http://www.usaco.org/>
- [69] H. C. von Warnsdorf. *Des Rösselsprunges einfachste und allgemeinste Lösung*. Schmalkalden, 1823.
- [70] S. Warshall. A theorem on boolean matrices. *Journal of the ACM*, 9(1):11–12, 1962.





# Index

- 2SAT problem, 160
- 2SUM problem, 78
- 3SAT problem, 162
- 3SUM problem, 79
  
- adjacency list, 113
- adjacency matrix, 114
- alphabet, 243
- amortized analysis, 77
- ancestor, 163
- and operation, 96
- Andrew's algorithm, 279
- antichain, 193
- arithmetic progression, 10
  
- backtracking, 50
- Bellman–Ford algorithm, 123
- binary code, 62
- binary indexed tree, 86
- binary search, 31
- binary tree, 139
- Binet's formula, 14
- binomial coefficient, 208
- binomial distribution, 230
- bipartite graph, 112, 122
- birthday paradox, 247
- bit representation, 95
- bit shift, 97
- bitset, 41
- border, 244
- breadth-first search, 119
- bubble sort, 25
- Burnside's lemma, 214
  
- Catalan number, 210
- Cayley's formula, 215
- child, 133
- Chinese remainder theorem, 205
  
- closest pair, 277
- codeword, 62
- cofactor, 219
- collision, 246
- coloring, 112, 233
- combinatorics, 207
- comparison function, 31
- comparison operator, 30
- complement, 12
- complete graph, 111
- complex, 266
- complex number, 266
- complexity classes, 20
- component, 110
- component graph, 157
- conditional probability, 227
- conjunction, 13
- connected graph, 110, 121
- constant factor, 21
- constant-time algorithm, 20
- coprime, 201
- counting sort, 28
- cross product, 268
- cubic algorithm, 20
- cut, 182
- cycle, 109, 121, 149, 155
- cycle detection, 155
  
- data compression, 62
- data structure, 35
- De Bruijn sequence, 178
- degree, 111
- depth-first search, 117
- deque, 42
- derangement, 213
- determinant, 219
- diameter, 135

difference, 12  
 difference array, 93  
 Dijkstra's algorithm, 126, 153  
 Dilworth's theorem, 193  
 Diophantine equation, 204  
 Dirac's theorem, 177  
 directed graph, 110  
 disjunction, 13  
 distance function, 272  
 distribution, 229  
 divisibility, 197  
 divisor, 197  
 dynamic array, 35  
 dynamic programming, 65  
 dynamic segment tree, 261  
  
 edge, 109  
 edge list, 115  
 edit distance, 74  
 Edmonds–Karp algorithm, 184  
 equivalence, 13  
 Euclid's algorithm, 200  
 Euclid's formula, 206  
 Euclidean distance, 272  
 Euler tour technique, 168  
 Euler's theorem, 202  
 Euler's totient function, 201  
 Eulerian circuit, 174  
 Eulerian path, 173  
 expected value, 229  
 extended Euclid's algorithm, 204  
  
 factor, 197  
 factorial, 14  
 Faulhaber's formula, 10  
 Fenwick tree, 86  
 Fermat's theorem, 202  
 Fibonacci number, 14, 206, 220  
 floating point number, 7  
 flow, 181  
 Floyd's algorithm, 155  
 Floyd–Warshall algorithm, 129  
 Ford–Fulkerson algorithm, 182  
 Freivalds' algorithm, 232  
 functional graph, 154  
  
 geometric distribution, 230  
 geometric progression, 11  
 geometry, 265  
 Goldbach's conjecture, 199  
 graph, 109  
 greatest common divisor, 200  
 greedy algorithm, 57  
 Grundy number, 238  
 Grundy's game, 241  
  
 Hall's theorem, 189  
 Hamiltonian circuit, 177  
 Hamiltonian path, 177  
 Hamming distance, 100  
 harmonic sum, 11, 200  
 hash value, 245  
 hashing, 245  
 heap, 43  
 Heron's formula, 265  
 heuristic, 179  
 Hierholzer's algorithm, 175  
 Huffman coding, 63  
  
 identity matrix, 218  
 implication, 13  
 in-order, 139  
 inclusion-exclusion, 212  
 indegree, 111  
 independence, 228  
 independent set, 190  
 index compression, 93  
 input and output, 4  
 integer, 6  
 intersection, 12  
 intersection point, 276  
 inverse matrix, 220  
 inversion, 26  
 iterator, 39  
  
 König's theorem, 189  
 Kadane's algorithm, 23  
 Kirchhoff's theorem, 223  
 knapsack, 72  
 knight's tour, 179  
 Kosaraju's algorithm, 158  
 Kruskal's algorithm, 142  
  
 Lagrange's theorem, 205  
 Laplacean matrix, 224

Las Vegas algorithm, 231  
 lazy propagation, 258  
 lazy segment tree, 258  
 leaf, 133  
 least common multiple, 200  
 Legendre's conjecture, 199  
 Levenshtein distance, 74  
 lexicographical order, 244  
 line segment intersection, 269  
 linear algorithm, 20  
 linear recurrence, 220  
 logarithm, 14  
 logarithmic algorithm, 20  
 logic, 13  
 longest increasing subsequence, 70  
 losing state, 235  
 lowest common ancestor, 167

macro, 9  
 Manhattan distance, 272  
 map, 38  
 Markov chain, 230  
 matching, 187  
 matrix, 217  
 matrix multiplication, 218, 232  
 matrix power, 219  
 maximum flow, 181  
 maximum independent set, 190  
 maximum matching, 187  
 maximum query, 83  
 maximum spanning tree, 141  
 maximum subarray sum, 21  
 meet in the middle, 54  
 memoization, 67  
 merge sort, 27  
 mex function, 238  
 minimum cut, 182, 185  
 minimum node cover, 189  
 minimum query, 83  
 minimum spanning tree, 141  
 misère game, 238  
 Mo's algorithm, 255  
 modular arithmetic, 6, 201  
 modular inverse, 202  
 Monte Carlo algorithm, 231  
 multinomial coefficient, 210

natural logarithm, 15  
 nearest smaller elements, 79  
 negation, 13  
 negative cycle, 125  
 neighbor, 111  
 next\_permutation, 49  
 nim game, 237  
 nim sum, 237  
 node, 109  
 node cover, 189  
 not operation, 97  
 NP-hard problem, 20  
 number theory, 197

or operation, 96  
 order statistic, 232  
 Ore's theorem, 177  
 outdegree, 111

pair, 30  
 parent, 133  
 parenthesis expression, 211  
 Pascal's triangle, 209  
 path, 109  
 path cover, 190  
 pattern matching, 243  
 perfect matching, 189  
 perfect number, 198  
 period, 243  
 permutation, 49  
 persistent segment tree, 262  
 Pick's theorem, 272  
 point, 266  
 polynomial algorithm, 20  
 polynomial hashing, 245  
 post-order, 139  
 Prüfer code, 216  
 pre-order, 139  
 predicate, 13  
 prefix, 243  
 prefix sum array, 84  
 Prim's algorithm, 147  
 prime, 197  
 prime decomposition, 197  
 priority queue, 43  
 probability, 225  
 programming language, 3

Pythagorean triple, 206  
 quadratic algorithm, 20  
 quantifier, 13  
 queen problem, 50  
 queue, 43  
 quickselect, 232  
 quicksort, 232  
  
 random variable, 228  
 random\_shuffle, 39  
 randomized algorithm, 231  
 range query, 83  
 regular graph, 111  
 remainder, 6  
 reverse, 39  
 root, 133  
 rooted tree, 133  
 rotation, 243  
  
 scaling algorithm, 185  
 segment tree, 89, 257  
 set, 12, 37  
 set theory, 12  
 shoelace formula, 271  
 shortest path, 123  
 sieve of Eratosthenes, 200  
 simple graph, 112  
 sliding window, 81  
 sliding window minimum, 81  
 sort, 29, 39  
 sorting, 25  
 spanning tree, 141, 223  
 sparse segment tree, 261  
 sparse table, 85  
 SPFA algorithm, 126  
 Sprague–Grundy theorem, 238  
 square matrix, 217  
 square root algorithm, 251  
 stack, 42  
 string, 36, 243  
 string hashing, 245  
 strongly connected component, 157  
 strongly connected graph, 157  
 subsequence, 243  
 subset, 12, 47  
 substring, 243  
 subtree, 133  
 successor graph, 154  
 suffix, 243  
 sum query, 83  
 sweep line, 275  
  
 time complexity, 17  
 topological sorting, 149  
 transpose, 217  
 tree, 110, 133  
 tree query, 163  
 tree traversal array, 164  
 trie, 244  
 tuple, 30  
 typedef, 8  
 twin prime, 199  
 two pointers method, 77  
 two-dimensional segment tree, 264  
  
 uniform distribution, 230  
 union, 12  
 union-find structure, 145  
 universal set, 12  
  
 vector, 35, 217, 266  
  
 Warnsdorf’s rule, 179  
 weighted graph, 111  
 Wilson’s theorem, 206  
 winning state, 235  
  
 xor operation, 97  
  
 Z-algorithm, 247  
 Z-array, 247  
 Zeckendorf’s theorem, 206